

Part Number: D3I1826K

Electrical Specifications

Frequency Range (GHz):	18.0 - 26.5
Isolation (dB):	18 MIN
Insertion Loss (dB):	0.8 MAX
VSWR:	1.4:1 MIN
Forward Power (W):	10 AVG 30 PK
Reflective Power (W):	2 AVG

Mechanical/Environmental Specifications

Connector Type:	K (2.92mm)
Connector Body:	Passivated stainless steel
Connector Pin:	Gold plated copper
Load Body:	Brass
Magnetic Shunt:	Nickel plated CRS
Operational Temp:	-20°C to +65°C
Weight (oz)	0.9 MAX

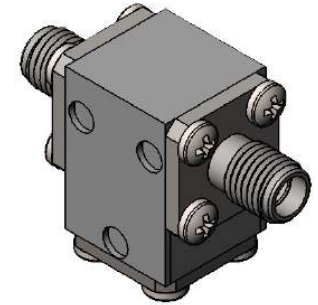

D3I1826K Dimensions

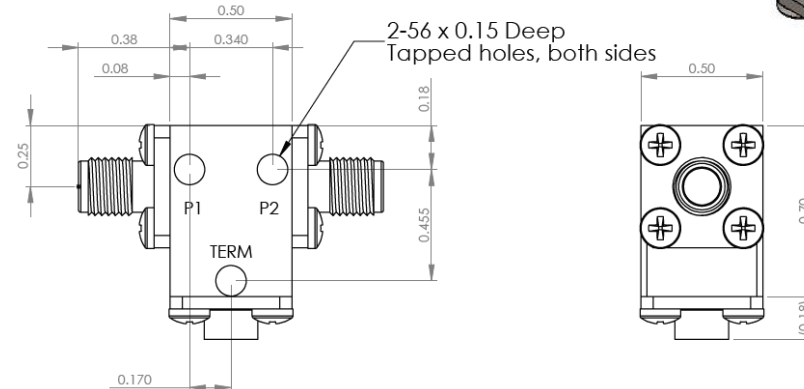

D3I1826K-3 Dimensions

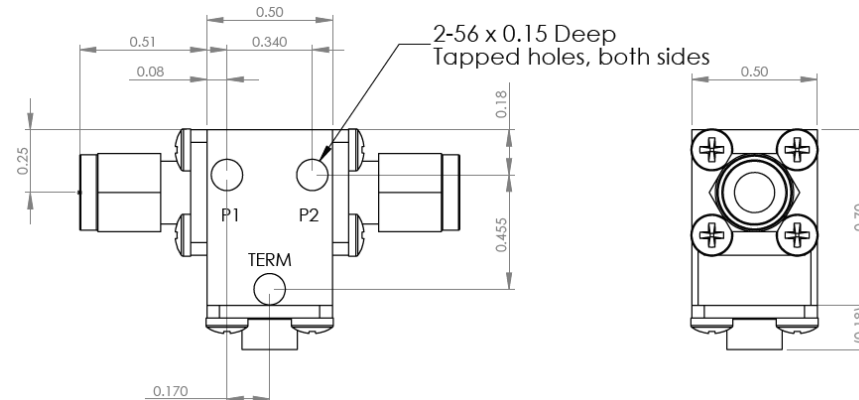

Dimensions are in inches
Tolerance

XX ±0.03
XXX ±0.010

Type of Device	PN Suffix	Connector Configuration Input / Output	PN Example
Single and Dual Junction Isolator, 2-Port Device Input / Output	N/A	Female / Female	D3I1826K
	-1	Male / Female	D3I1826K-1
	-2	Female / Male	D3I1826K-2
	-3	Male / Male	D3I1826K-3



MEASURED DATA

Part Number: D3I1826K, +25°C

