

Standard Heat Sinks

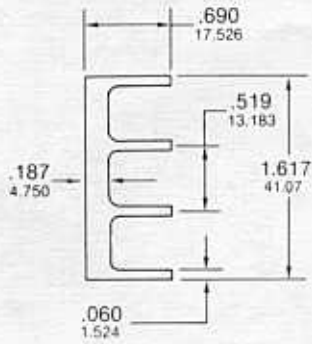

Material 6063-T5 Aluminum
Finish Black Anodize

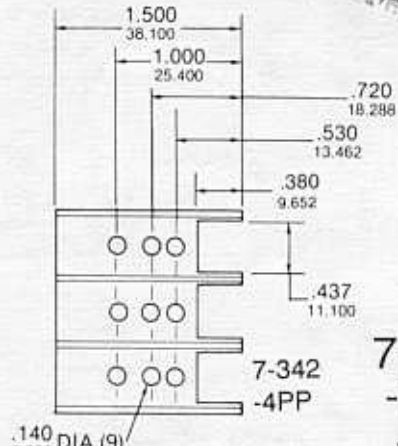
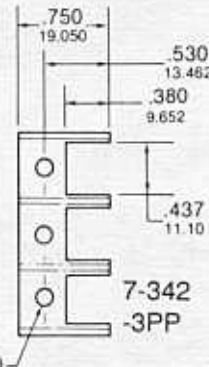
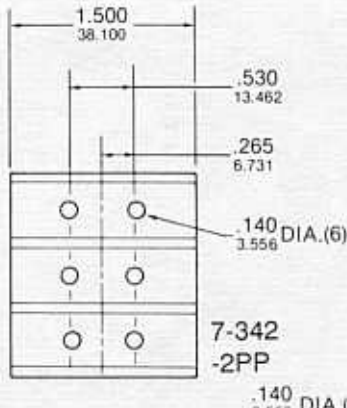
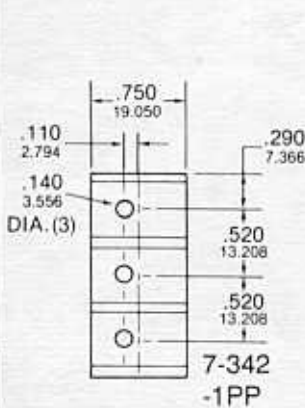
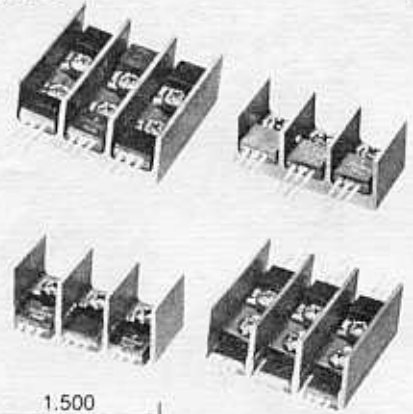
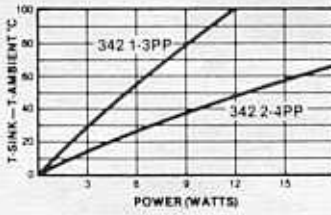

7-342
-1,-2,
-3,-4

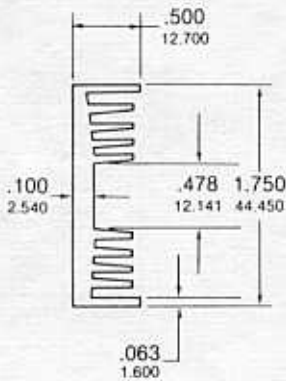

Material 6063-T5 Aluminum
Finish Black Anodize

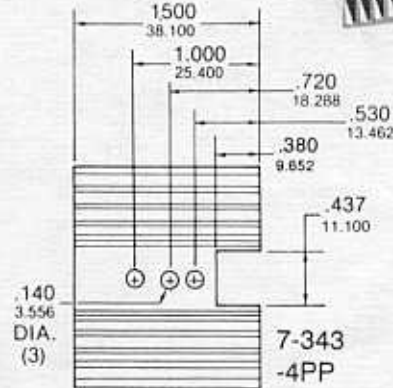
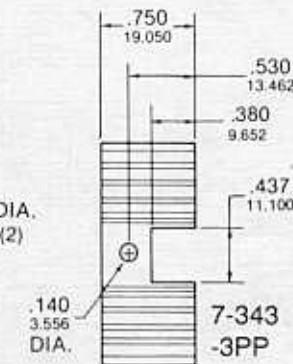
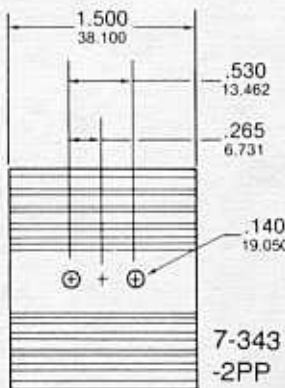
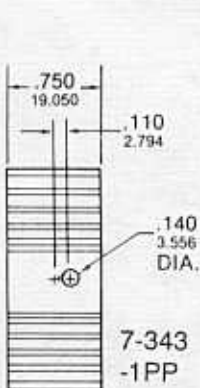
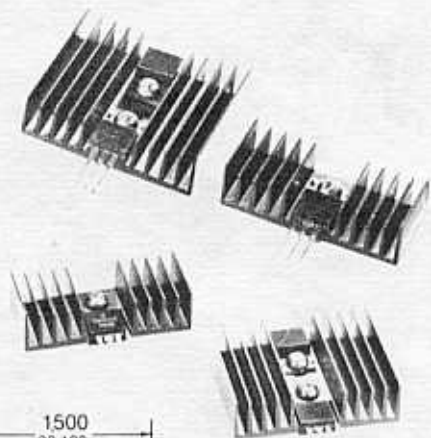
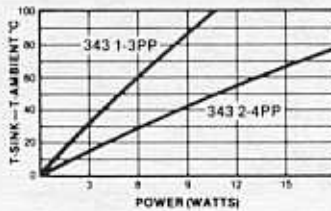

7-343
-1,-2,
-3,-4

Low Power