

About Samsung Electronics Co., Ltd.

Samsung Electronics Co. Ltd inspires the world and shapes the future with transformative ideas and technologies. The company is redefining the worlds of TVs, smartphones, wearable devices, tablets, digital appliances, network systems, and semiconductor and LED solutions. For the latest news, please visit the Samsung Newsroom at <http://news.samsung.com>.

Copyright © 2020 Samsung Electronics Co., Ltd. All rights reserved. Samsung Electronics reserves the right to modify, at its sole discretion, the design, packaging, specifications, and features shown herein without notice at any time.

Samsung Electronics Co., Ltd.
Samsung-ro 1, Giheung-gu, Yongin-si,
Gyeonggi-do, 17113 Korea

www.samsungled.com

SAMSUNG LED

Tomorrow / Technology / Together

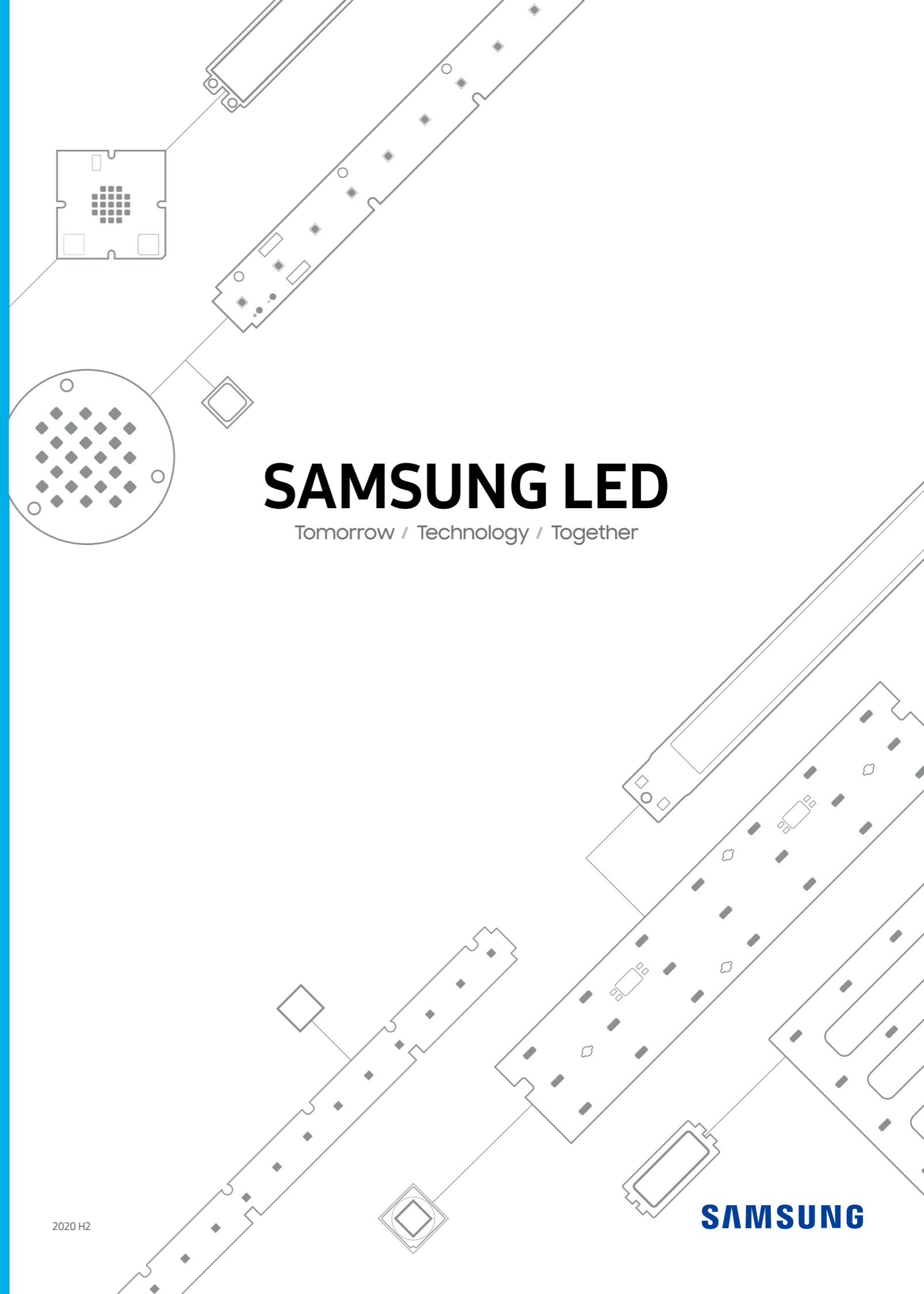

Overview & Technology

Samsung Electronics Co., Ltd. is a global leader in consumer electronics and the core components that go into them.



Samsung aspires to create new technologies and innovative products that inspire the world, while delivering new value to enhance the lives of customers, partners and employees.

Vertically Integrated Solution Provider

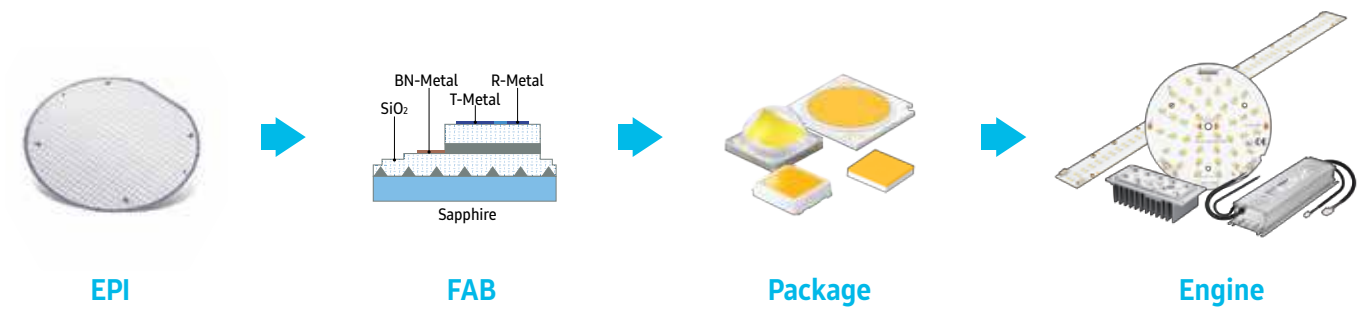

Samsung Electronics



1969
Company
Founded



Vision 2020
Inspire the World,
Create the Future



309,630+
Employees
in 79 Countries

Reliable, On-Time Delivery without Delays



Innovation & Market Leadership



7
Design Centers



37
R&D Centers



5th
Best Global Brand 2020

Life and LED Business Solution Partner

LED technology has started a new era of innovation and game-changing trends affecting diverse applications and lighting industries.

In particular, as countries around the world strengthen energy conservation programs and push for related legislation enforcement,

demand for energy-efficient lighting is on the rise at a rapid pace.

Samsung's LED Business aims to achieve excellence as a long life,

energy saving and eco-friendly light source supplier in lighting applications.

Samsung's advanced semiconductor manufacturing expertise serves as a strong foundation to deliver state-of-the-art LED devices.

CONTENTS

Package

- 09 CSP LEDs
- 15 Mid Power LEDs
- 36 Filament LEDs
- 38 High Power LEDs
- 44 COB LEDs



Module

- 108 Ambient Light
- 117 Industrial Light
- 123 Down Light
- 126 Outdoor Light



Driver

- 132 Ambient Light
- 132 Down & Spot Light
- 133 Outdoor Light



Specialty Lighting

- 140 Human-centric Light
- 142 Horticulture Light
- 147 Retail Light
- 156 Sports Light



Package

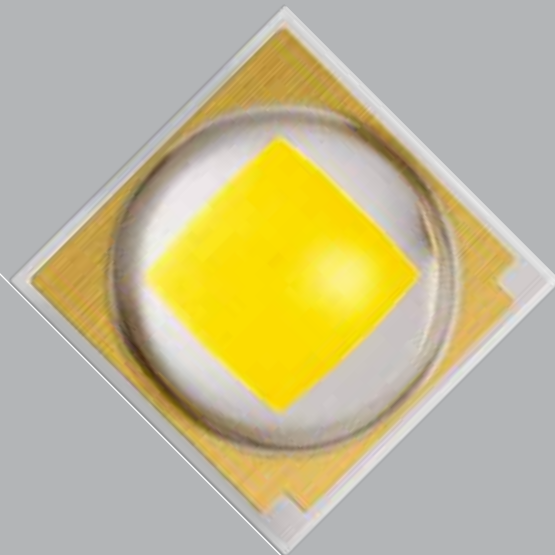
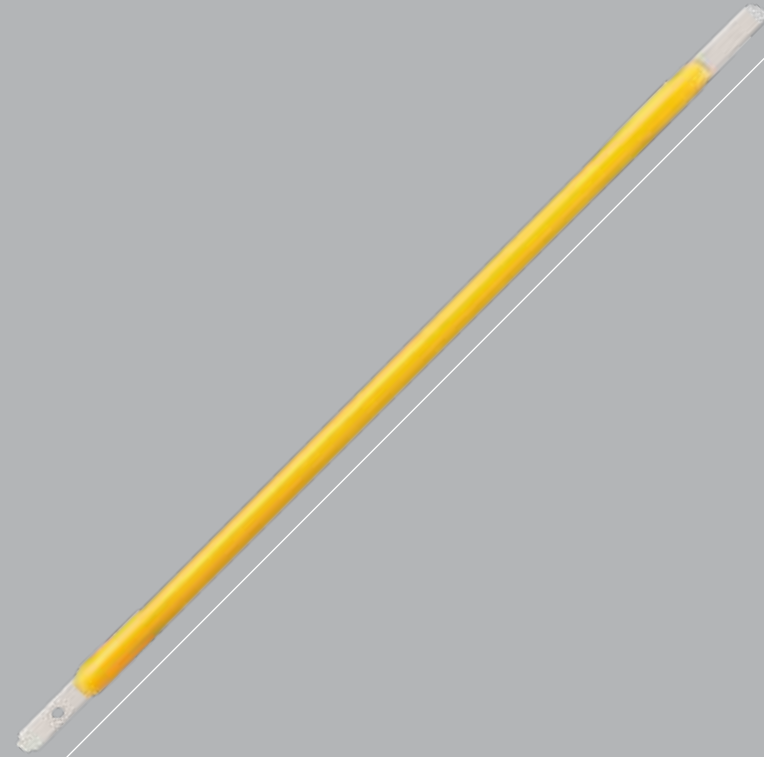

- CSP LEDs
- Mid Power LEDs
- Filament LEDs
- High Power LEDs
- COB LEDs

Samsung LED

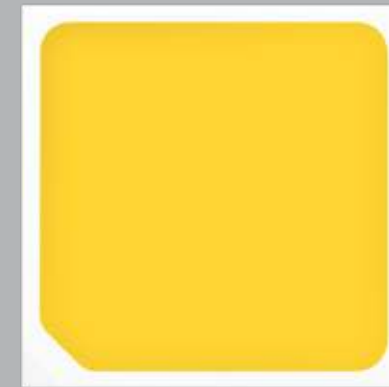
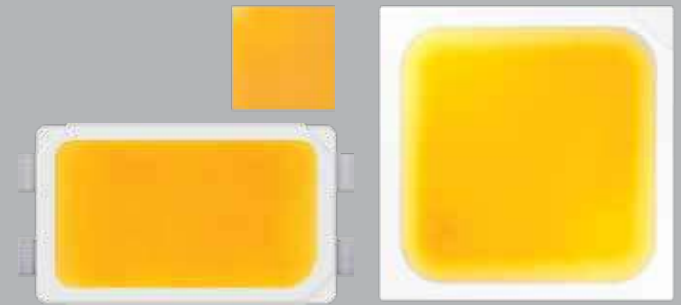

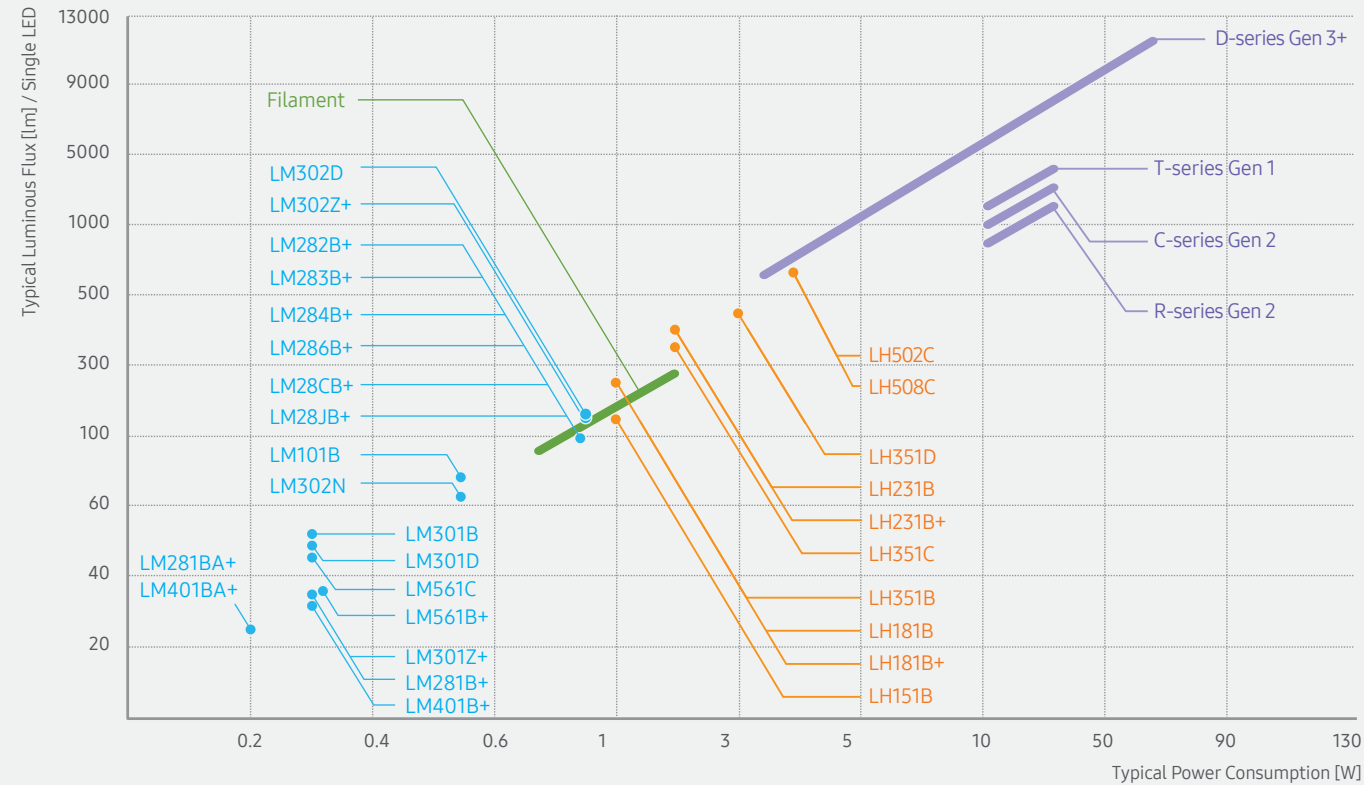

Mid Power LEDs

- High efficacy
- Great design flexibility
- Suitable for almost all lights

Filment LEDs

- Aesthetic appearance
- Large freedom in bulb design
- Decorative and general lighting bulbs

High Power LEDs

- Ultra high flux
- Provides excellent color consistency
- Street, tunnel and sports lights

Chip-on-Board LEDs

- Chip on Board solution
- Outstanding color rendering & consistency
- MR/PAR, spotlight, high/low bay light

LM101B



Compact form factor for design flexibility

- 0.5W class mid-power 3V LED
- Compact footprint: 1.7mm x 1.7mm

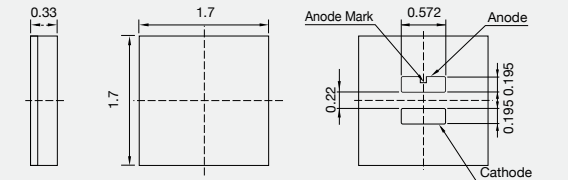

[150mA, 85°C]

CRI	CCT (K)	Part Number	Luminous Flux (lm)		
			Bin	Min.	Max.
70+	2700	SCP7WT78HEL1W☆S06E	SE	59	63
			SF	63	67
			SG	67	71
	3000	SCP7VT78HEL1V☆S06E	SF	63	67
			SG	67	71
			SH	71	75
	3500	SCP7UT78HEL1U☆S06E	SF	63	67
			SG	67	71
			SH	71	75
	4000	SCP7TT78HEL1T☆S06E	SG	67	71
			SH	71	75
			SJ	75	70
5000	SCP7RT78HEL1R☆S06E	SG	67	71	
		SH	71	75	
		SJ	75	70	
5700	SCP7QT78HEL1Q☆S06E	SF	63	67	
		SG	67	71	
		SH	71	75	
6500	SCP7PT78HEL1P☆S06E	SF	63	67	
		SG	67	71	
		SH	71	75	
80+	2700	SCP8WT78HEL1W☆S06E	SE	59	63
			SF	63	67
			SG	67	71
	3000	SCP8VT78HEL1V☆S06E	SE	59	63
			SF	63	67
			SG	67	71
	3500	SCP8UT78HEL1U☆S06E	SF	63	67
			SG	67	71
			SH	71	75
	4000	SCP8TT78HEL1T☆S06E	SF	63	67
			SG	67	71
			SH	71	75
5000	SCP8RT78HEL1R☆S06E	SF	63	67	
		SG	67	71	
		SH	71	75	
5700	SCP8QT78HEL1Q☆S06E	SF	63	67	
		SG	67	71	
		SH	71	75	
6500	SCP8PT78HEL1P☆S06E	SE	59	63	
		SF	63	67	
		SG	67	71	

CRI	CCT (K)	Part Number	Luminous Flux (lm)		
			Bin	Min.	Max.
90+	2700	SCP9WT78HEL1W☆S06E	SB	47	51
			SC	51	55
			SD	55	59
	3000	SCP9VT78HEL1V☆S06E	SB	47	51
			SC	51	55
			SD	55	59
	3500	SCP9UT78HEL1U☆S06E	SB	47	51
			SC	51	55
			SD	55	59
	4000	SCP9TT78HEL1T☆S06E	SC	51	55
			SE	59	63
			SD	55	59
	5000	SCP9RT78HEL1R☆S06E	SC	51	55
			SE	59	63
			SD	55	59

Note: "☆" can be "L" (MacAdam 5-step), "U" (MacAdam 3-step)

LH151B

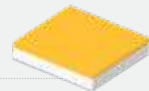

Compact form factor for design flexibility

- 2W class high power CSP
- Suitable for high/low bay lighting
- Compact footprint: 1.7mm x 1.7mm

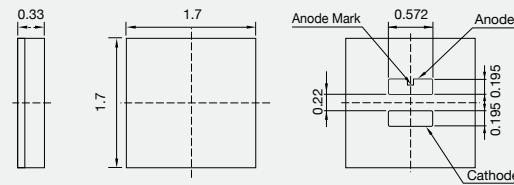

[350mA, 85°C]

CRI	CCT (K)	Part Number	Luminous Flux (lm)		
			Bin	Min.	Max.
70+	2700	SCP7WT93KEL1W◇K36E	K1, M1, N1	130	160
	3000	SCP7VT93KEL1V◇M36E	M1, N1, P1	140	170
	3500	SCP7UT93KEL1U◇M36E	M1, N1, P1	140	170
	4000	SCP7TT93KEL1T◇N36E	N1, P1, Q1	150	180
	5000	SCP7RT93KEL1R◇N36E	N1, P1, Q1	150	180
	5700	SCP7QT93KEL1Q◇M36E	M1, N1, P1	140	170
80+	6500	SCP7PT93KEL1P◇M36E	M1, N1, P1	140	170
	2700	SCP8WT93KEL1W◇J36E	J1, K1, M1	120	150
	3000	SCP8VT93KEL1V◇J36E	J1, K1, M1	120	150
	3500	SCP8UT93KEL1U◇K36E	K1, M1, N1	130	160
	4000	SCP8TT93KEL1T◇K36E	K1, M1, N1	130	160
	5000	SCP8RT93KEL1R◇M36E	M1, N1, P1	140	170
90+	5700	SCP8QT93KEL1Q◇M36E	M1, N1, P1	140	170
	6500	SCP8PT93KEL1P◇K36E	K1, M1, N1	130	160
	2700	SCP9WT93KEL1W◇F36E	F1, G1, H1	90	120
	3000	SCP9VT93KEL1V◇F36E	F1, G1, H1	90	120
	3500	SCP9UT93KEL1U◇G36E	G1, H1, J1	100	130
	4000	SCP9TT93KEL1T◇G36E	G1, H1, J1	100	130
5000	SCP9RT93KEL1R◇G36E	G1, H1, J1	100	130	

* "◇" can be "L" (MacAdam 5-step ellipse bin), "U" (MacAdam 3-step ellipse bin) of the color binning

LH181B



Compact form factor for design flexibility

- 3W class high power CSP
- Higher performance by applying new structure
- Compact footprint: 2.36mm x 2.36mm

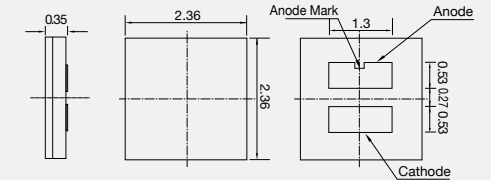

[350mA, 85°C]

CRI	CCT (K)	Part Number	Luminous Flux (lm)		
			Bin	Min.	Max.
70+	2700	SCP7WTF1HEL1W◇M34E	M1, N1, P1	140	170
	3000	SCP7VTF1HEL1V◇N34E	N1, P1, Q1	150	180
	3500	SCP7UTF1HEL1U◇N34E	N1, P1, Q1	150	180
	4000	SCP7TTF1HEL1T◇P34E	P1, Q1, R1	160	190
	5000	SCP7RTF1HEL1R◇P34E	P1, Q1, R1	160	190
	5700	SCP7QTF1HEL1Q◇P34E	P1, Q1, R1	160	190
80+	6500	SCP7PTF1HEL1P◇N34E	N1, P1, Q1	150	180
	2200	SCP8YTF1HEL1Y◇H34E	H1, J1, K1	110	140
	2700	SCP8WTF1HEL1W◇K34E	K1, M1, N1	130	160
	3000	SCP8VTF1HEL1V◇K34E	K1, M1, N1	130	160
	3500	SCP8UTF1HEL1U◇M34E	M1, N1, P1	140	170
	4000	SCP8TTF1HEL1T◇M34E	M1, N1, P1	140	170
90+	5000	SCP8RTF1HEL1R◇N34E	N1, P1, Q1	150	180
	5700	SCP8QTF1HEL1Q◇N34E	N1, P1, Q1	150	180
	6500	SCP8PTF1HEL1P◇M34E	M1, N1, P1	140	170
	2700	SCP9WTF1HEL1W◇G34E	G1, H1, J1	100	130
	3000	SCP9VTF1HEL1V◇G34E	G1, H1, J1	100	130
	3500	SCP9UTF1HEL1U◇H34E	H1, J1, K1	110	140
90+	4000	SCP9TTF1HEL1T◇H34E	H1, J1, K1	110	140
	5000	SCP9RTF1HEL1R◇H34E	H1, J1, K1	110	140

* "◇" can be "K" (MacAdam 5-step ellipse bin), "U" (MacAdam 3-step ellipse bin) of the color binning

LH181B +



Compact form factor for design flexibility

- 3W class high power CSP
- Improved lifetime
- Higher performance by applying new structure
- Compact footprint: 2.36mm x 2.36mm

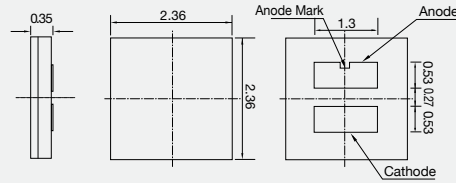

[350mA, 85°C]

CRI	CCT (K)	Part Number	Luminous Flux (lm)		
			Bin	Min.	Max.
70+	2700	SCP7WTF1HELAW◇M34E	M1, N1, P1	140	170
	3000	SCP7VTF1HELAV◇N34E	N1, P1, Q1	150	180
	3500	SCP7UTF1HELAU◇N34E	N1, P1, Q1	150	180
	4000	SCP7TTF1HELAT◇P34E	P1, Q1, R1	160	190
	5000	SCP7RTF1HELAR◇P34E	P1, Q1, R1	160	190
	5700	SCP7QTF1HELAQ◇P34E	P1, Q1, R1	160	190
	6500	SCP7PTF1HELAP◇N34E	N1, P1, Q1	150	180
80+	2200	SCP8YTF1HELAY◇H34E	H1, J1, K1	110	140
	2700	SCP8WTF1HELAW◇K34E	K1, M1, N1	130	160
	3000	SCP8VTF1HELAV◇K34E	K1, M1, N1	130	160
	3500	SCP8UTF1HELAU◇M34E	M1, N1, P1	140	170
	4000	SCP8TTF1HELAT◇M34E	M1, N1, P1	140	170
	5000	SCP8RTF1HELAR◇N34E	N1, P1, Q1	150	180
	5700	SCP8QTF1HELAQ◇N34E	N1, P1, Q1	150	180
90+	6500	SCP8PTF1HELAP◇M34E	M1, N1, P1	140	170
	2700	SCP9WTF1HELAW◇G34E	G1, H1, J1	100	130
	3000	SCP9VTF1HELAV◇G34E	G1, H1, J1	100	130
	3500	SCP9UTF1HELAU◇H34E	H1, J1, K1	110	140
	4000	SCP9TTF1HELAT◇H34E	H1, J1, K1	110	140
	5000	SCP9RTF1HELAR◇H34E	H1, J1, K1	110	140

* "◇" can be "K" (MacAdam 5-step ellipse bin), "U" (MacAdam 3-step ellipse bin) of the color binning

LH231B



Compact form factor for design flexibility

- 5W class super high power CSP
- Suitable for highbay lighting, stadium lighting
- Compact footprint: 2.8mm x 2.8mm

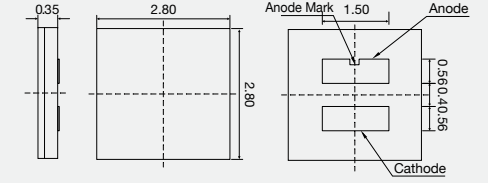

[700mA, 85°C]

CRI	CCT (K)	Part Number	Luminous Flux (lm)		
			Bin	Min.	Max.
70+	2700	SCP7WTJ5HEL1W☆MF6E	MB, NB, PB	250	310
	3000	SCP7VTJ5HEL1V☆NF6E	NB, PB, QB	270	330
	3500	SCP7UTJ5HEL1U☆PF6E	PB, QB, RB	290	350
	4000	SCP7TTJ5HEL1T☆QF6E	QB, RB, SB	310	370
	5000	SCP7RTJ5HEL1R☆QF6E	QB, RB, SB	310	370
	5700	SCP7QTJ5HEL1Q☆QF6E	QB, RB, SB	310	370
	6500	SCP7PTJ5HEL1P☆PF6E	PB, QB, RB	290	350
80+	2700	SCP8WTJ5HEL1W☆MF6E	MB, NB, PB	250	310
	3000	SCP8VTJ5HEL1V☆MF6E	MB, NB, PB	250	310
	3500	SCP8UTJ5HEL1U☆NF6E	NB, PB, QB	270	330
	4000	SCP8TTJ5HEL1T☆NF6E	NB, PB, QB	270	330
	5000	SCP8RTJ5HEL1R☆PF6E	PB, QB, RB	290	350
	5700	SCP8QTJ5HEL1Q☆NF6E	NB, PB, QB	270	330
	6500	SCP8PTJ5HEL1P☆NF6E	NB, PB, QB	270	330
90+	2700	SCP9WTJ5HEL1W☆HF6E	HB, JB, KB	190	250
	3000	SCP9VTJ5HEL1V☆HF6E	HB, JB, KB	190	250
	3500	SCP9UTJ5HEL1U☆JF6E	JB, KB, MB	210	270
	4000	SCP9TTJ5HEL1T☆JF6E	JB, KB, MB	210	270

* "☆" can be "L" (MacAdam 5-step ellipse bin), "U" (MacAdam 3-step ellipse bin) of the color binning

LH231B +



Compact form factor for design flexibility

- 5W class super high power CSP
- Improved lifetime
- Suitable for highbay lighting, stadium lighting
- Compact footprint: 2.8mm x 2.8mm

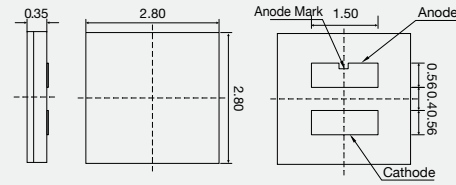

[700mA, 85°C]

CRI	CCT (K)	Part Number	Luminous Flux (lm)		
			Bin	Min.	Max.
70+	2700	SCP7WTJ5HELAW☆MF6E	MB, NB, PB	250	310
	3000	SCP7VTJ5HELAV☆NF6E	NB, PB, QB	270	330
	3500	SCP7UTJ5HELAV☆PF6E	PB, QB, RB	290	350
	4000	SCP7TTJ5HELAT☆QF6E	QB, RB, SB	310	370
	5000	SCP7RTJ5HELAR☆QF6E	QB, RB, SB	310	370
	5700	SCP7QTJ5HELAR☆QF6E	QB, RB, SB	310	370
	6500	SCP7PTJ5HELAP☆PF6E	PB, QB, RB	290	350
80+	2700	SCP8WTJ5HELAW☆MF6E	MB, NB, PB	250	310
	3000	SCP8VTJ5HELAV☆MF6E	MB, NB, PB	250	310
	3500	SCP8UTJ5HELAV☆NF6E	NB, PB, QB	270	330
	4000	SCP8TTJ5HELAT☆NF6E	NB, PB, QB	270	330
	5000	SCP8RTJ5HELAR☆PF6E	PB, QB, RB	290	350
	5700	SCP8QTJ5HELAR☆NF6E	NB, PB, QB	270	330
	6500	SCP8PTJ5HELAP☆NF6E	NB, PB, QB	270	330
90+	2700	SCP9WTJ5HELAW☆HF6E	HB, JB, KB	190	250
	3000	SCP9VTJ5HELAV☆HF6E	HB, JB, KB	190	250
	3500	SCP9UTJ5HELAV☆JF6E	JB, KB, MB	210	270
	4000	SCP9TTJ5HELAT☆JF6E	JB, KB, MB	210	270

* ☆ can be "L" (MacAdam 5-step ellipse bin), "U" (MacAdam 3-step ellipse bin) of the color binning

LM281BA +



Designed for better lm/\$

- 0.2W class mid power 3V LED
- Suitable for ambient lights, downlights & lamps
- Standard footprint: 2.8mm x 3.5mm

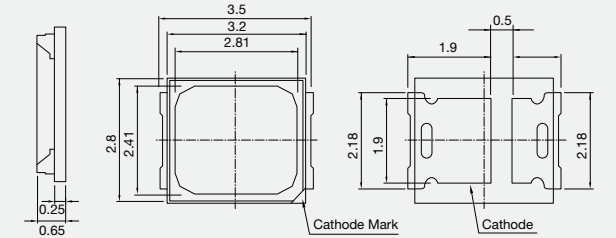

[60mA, 25°C]

CRI	CCT (K)	Part Number	Luminous Flux (lm)		
			Bin	Min.	Max.
80+	2700	SPMWH22286D5WAW0S2	S2	23	25
		SPMWH22286D5WAW0S3	S3	25.5	27.5
	3000	SPMWH22286D5WAV0S2	S2	23.5	25.5
		SPMWH22286D5WAV0S3	S3	26.5	28.5
	3500	SPMWH22286D5WAV0S2	S2	24	26
		SPMWH22286D5WAV0S3	S3	27	29
	4000	SPMWH22286D5WAT0S2	S2	25	27
		SPMWH22286D5WAT0S3	S3	28	30
	5000	SPMWH22286D5WAR0S2	S2	25.5	27.5
		SPMWH22286D5WAR0S3	S3	28.5	30.5
	5700	SPMWH22286D5WAQ0S2	S2	25.5	27.5
		SPMWH22286D5WAQ0S3	S3	28	30
	6500	SPMWH22286D5WAP0S2	S2	25	27
		SPMWH22286D5WAP0S3	S3	28	30
90+	2700	SPMWH22286D7WAW0S2	S2	19	20.5
		SPMWH22286D7WAW0S3	S3	21.5	23
	3000	SPMWH22286D7WAV0S2	S2	19.5	21
		SPMWH22286D7WAV0S3	S3	22.5	24
	3500	SPMWH22286D7WAV0S2	S2	20	21.5
		SPMWH22286D7WAV0S3	S3	23	24.5
	4000	SPMWH22286D7WAT0S2	S2	21	22.5
		SPMWH22286D7WAT0S3	S3	24	25.5
	5000	SPMWH22286D7WAR0S2	S2	21.5	23
		SPMWH22286D7WAR0S3	S3	24.5	26
	5700	SPMWH22286D7WAQ0S2	S2	21.5	23
		SPMWH22286D7WAQ0S3	S3	24	25.5
	6500	SPMWH22286D7WAP0S2	S2	21	22.5
		SPMWH22286D7WAP0S3	S3	24	25.5

LM281B + Pro



Designed for better lm/\$

- 0.5W class mid power LED
- Suitable for ambient lights, downlights & lamps
- Standard footprint: 2.8mm x 3.5mm

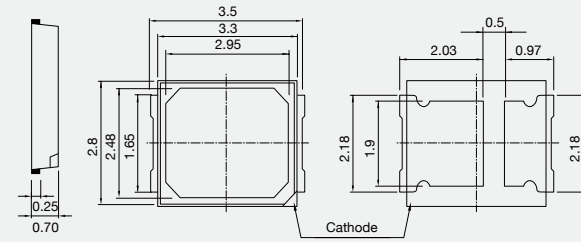

[65mA, 25°C]

CRI	CCT (K)	Part Number	Luminous Flux (lm)			
			Bin	Min.	Max.	
80+	2700	SPMWH1228MD5WAW0VK	VK	32.5	34.5	
		SPMWH1228MD5WAW0VL	VL	34	36	
	3000	SPMWH1228MD5WAV0VK	VK	33.5	35.5	
		SPMWH1228MD5WAV0VL	VL	35	37	
	3500	SPMWH1228MD5WU0VK	VK	34	36	
		SPMWH1228MD5WU0VL	VL	35.5	37.5	
	4000	SPMWH1228MD5WAT0VK	VK	35	37	
		SPMWH1228MD5WAT0VL	VL	36.5	38.5	
	5000	SPMWH1228MD5WAR0VK	VK	35.5	37.5	
		SPMWH1228MD5WAR0VL	VL	36.5	38.5	
	5700	SPMWH1228MD5WAQ0VK	VK	35	37	
		SPMWH1228MD5WAQ0VL	VL	36.5	38.5	
	6500	SPMWH1228MD5WAP0VK	VK	35	37	
		SPMWH1228MD5WAP0VL	VL	36.5	38.5	
	90+	2700	SPMWH1228MD7WAW0VK	VK	27.5	29.5
			SPMWH1228MD7WAW0VL	VL	28.5	30.5
3000		SPMWH1228MD7WAV0VK	VK	28.5	30.5	
		SPMWH1228MD7WAV0VL	VL	29.5	31.5	
3500		SPMWH1228MD7WU0VK	VK	29.5	31.5	
		SPMWH1228MD7WU0VL	VL	30.5	32.5	
4000		SPMWH1228MD7WAT0VK	VK	30.5	32.5	
		SPMWH1228MD7WAT0VL	VL	31.5	33.5	
5000		SPMWH1228MD7WAR0VK	VK	32	34	
		SPMWH1228MD7WAR0VL	VL	31.5	33.5	
5700		SPMWH1228MD7WAQ0VK	VK	31	33	
		SPMWH1228MD7WAQ0VL	VL	31.5	33.5	
6500		SPMWH1228MD7WAP0VK	VK	30.5	32.5	
		SPMWH1228MD7WAP0VL	VL	31.5	33.5	

[150mA, 25°C]

CRI	CCT (K)	Part Number	Luminous Flux (lm)			
			Bin	Min.	Max.	
80+	2700	SPMWH1228FD5WAW0VG	VG	66.5	70.5	
		SPMWH1228FD5WAW0VJ	VJ	70.5	74.5	
	3000	SPMWH1228FD5WAV0VG	VG	68.5	72.5	
		SPMWH1228FD5WAV0VJ	VJ	72.5	76.5	
	3500	SPMWH1228FD5WU0VG	VG	69.5	73.5	
		SPMWH1228FD5WU0VJ	VJ	73.5	77.5	
	4000	SPMWH1228FD5WAT0VG	VG	72	76	
		SPMWH1228FD5WAT0VJ	VJ	76	80	
	5000	SPMWH1228FD5WAR0VG	VG	73	77	
		SPMWH1228FD5WAR0VJ	VJ	77	81	
	5700	SPMWH1228FD5WAQ0VG	VG	72.5	76.5	
		SPMWH1228FD5WAQ0VJ	VJ	76.5	80.5	
	6500	SPMWH1228FD5WAP0VG	VG	72	76	
		SPMWH1228FD5WAP0VJ	VJ	76	80	
	90+	2700	SPMWH1228FD7WAW0VG	VG	56.5	60.5
			SPMWH1228FD7WAW0VJ	VJ	59.5	63.5
3000		SPMWH1228FD7WAV0VG	VG	58	62	
		SPMWH1228FD7WAV0VJ	VJ	61	65	
3500		SPMWH1228FD7WU0VG	VG	59	63	
		SPMWH1228FD7WU0VJ	VJ	62	66	
4000		SPMWH1228FD7WAT0VG	VG	61	65	
		SPMWH1228FD7WAT0VJ	VJ	64	68	
5000		SPMWH1228FD7WAR0VG	VG	62	66	
		SPMWH1228FD7WAR0VJ	VJ	65	69	
5700		SPMWH1228FD7WAQ0VG	VG	61.5	65.5	
		SPMWH1228FD7WAQ0VJ	VJ	64.5	68.5	
6500		SPMWH1228FD7WAP0VG	VG	61	65	
		SPMWH1228FD7WAP0VJ	VJ	64	68	

LM281B +



Designed for better lm/\$

- 0.5W class mid power LED
- Suitable for ambient lights, downlights & lamps
- Standard footprint: 2.8mm x 3.5mm

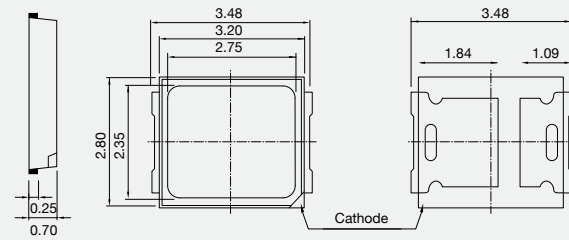

[150mA, 25°C]

CRI	CCT (K)	Part Number	Luminous Flux (lm)		
			Bin	Min.	Max.
80+	2700	SPMWH1228FD5WAW0SA	SA	54.5	58.5
		SPMWH1228FD5WAW0SC	SC	58.5	62.5
		SPMWH1228FD5WAW0SE	SE	62.5	66.5
		SPMWH1228FD5WAW0RG	RG	66.5	70.5
		SPMWH1228FD5WAW0RJ	RJ	70.5	74.5
		SPMWH1228FD5WAV0SA	SA	56.5	60.5
	3000	SPMWH1228FD5WAV0SC	SC	60.5	64.5
		SPMWH1228FD5WAV0SE	SE	64.5	68.5
		SPMWH1228FD5WAV0RG	RG	68.5	72.5
		SPMWH1228FD5WAV0RJ	RJ	72.5	76.5
		SPMWH1228FD5WAW0SA	SA	57.5	61.5
		SPMWH1228FD5WAW0SC	SC	61.5	65.5
	3500	SPMWH1228FD5WAW0SE	SE	65.5	69.5
		SPMWH1228FD5WAW0RG	RG	69.5	73.5
		SPMWH1228FD5WAW0RJ	RJ	73.5	77.5
		SPMWH1228FD5WAT0SA	SA	60	64
		SPMWH1228FD5WAT0SC	SC	64	68
		SPMWH1228FD5WAT0SE	SE	68	72
	4000	SPMWH1228FD5WAT0RG	RG	72	76
		SPMWH1228FD5WAT0RJ	RJ	76	80
		SPMWH1228FD5WAR0SA	SA	61	65
		SPMWH1228FD5WAR0SC	SC	65	69
		SPMWH1228FD5WAR0SE	SE	69	73
		SPMWH1228FD5WAR0RG	RG	73	77
	5000	SPMWH1228FD5WAR0RJ	RJ	77	81
		SPMWH1228FD5WAQ0SA	SA	60.5	64.5
		SPMWH1228FD5WAQ0SC	SC	64.5	68.5
		SPMWH1228FD5WAQ0SE	SE	68.5	72.5
		SPMWH1228FD5WAQ0RG	RG	72.5	76.5
		SPMWH1228FD5WAQ0RJ	RJ	76.5	80.5
6500	SPMWH1228FD5WAP0SA	SA	60	64	
	SPMWH1228FD5WAP0SC	SC	64	68	
	SPMWH1228FD5WAP0SE	SE	68	72	
	SPMWH1228FD5WAP0RG	RG	72	76	
	SPMWH1228FD5WAP0RJ	RJ	76	80	

CRI	CCT (K)	Part Number	Luminous Flux (lm)		
			Bin	Min.	Max.
90+	2700	SPMWH1228FD7WAW0SA	SA	44.5	48.5
		SPMWH1228FD7WAW0SC	SC	48.5	52.5
		SPMWH1228FD7WAW0SE	SE	52.5	56.5
		SPMWH1228FD7WAW0RG	RG	56.5	60.5
		SPMWH1228FD7WAW0RJ	RJ	59.5	63.5
		SPMWH1228FD7WAV0SA	SA	46	50
	3000	SPMWH1228FD7WAV0SC	SC	50	54
		SPMWH1228FD7WAV0SE	SE	54	58
		SPMWH1228FD7WAV0RG	RG	58	62
		SPMWH1228FD7WAV0RJ	RJ	61	65
		SPMWH1228FD7WAW0SA	SA	47	51
		SPMWH1228FD7WAW0SC	SC	51	55
	3500	SPMWH1228FD7WAW0SE	SE	55	59
		SPMWH1228FD7WAW0RG	RG	59	63
		SPMWH1228FD7WAW0RJ	RJ	62	66
		SPMWH1228FD7WAT0SA	SA	49	53
		SPMWH1228FD7WAT0SC	SC	53	57
		SPMWH1228FD7WAT0SE	SE	57	61
	4000	SPMWH1228FD7WAT0RG	RG	61	65
		SPMWH1228FD7WAT0RJ	RJ	64	68
		SPMWH1228FD7WAR0SA	SA	50	54
		SPMWH1228FD7WAR0SC	SC	54	58
		SPMWH1228FD7WAR0SE	SE	58	62
		SPMWH1228FD7WAR0RG	RG	62	66
	5000	SPMWH1228FD7WAR0RJ	RJ	65	69
		SPMWH1228FD7WAQ0SA	SA	49.5	53.5
		SPMWH1228FD7WAQ0SC	SC	53.5	57.5
		SPMWH1228FD7WAQ0SE	SE	57.5	61.5
		SPMWH1228FD7WAQ0RG	RG	61.5	65.5
		SPMWH1228FD7WAQ0RJ	RJ	64.5	68.5
6500	SPMWH1228FD7WAP0SA	SA	49	53	
	SPMWH1228FD7WAP0SC	SC	53	57	
	SPMWH1228FD7WAP0SE	SE	57	61	
	SPMWH1228FD7WAP0RG	RG	61	65	
	SPMWH1228FD7WAP0RJ	RJ	64	68	

[65mA, 25°C]

CRI	CCT (K)	Part Number	Luminous Flux (lm)		
			Bin	Min.	Max.
80+	2700	SPMWH1228MD5WAW0RK	RK	32.5	34.5
	3000	SPMWH1228MD5WAV0RK	RK	33.5	35.5
	3500	SPMWH1228MD5WAW0RK	RK	34	36
	4000	SPMWH1228MD5WAT0RK	RK	35	37
	5000	SPMWH1228MD5WAR0RK	RK	35.5	37.5
	5700	SPMWH1228MD5WAQ0RK	RK	35	37
	6500	SPMWH1228MD5WAP0RK	RK	35	37

LM282B +



Designed for better lm/\$

- 1W class mid power 6V LED
- Suitable for downlights, ambient lights & lamps
- Standard footprint: 2.8mm x 3.5mm

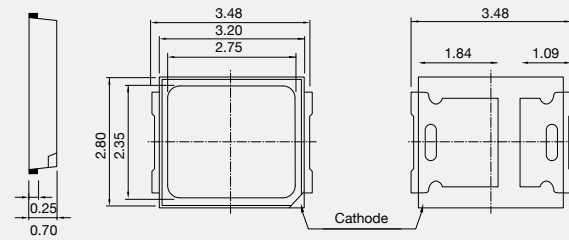

[150mA, 25°C]

CRI	CCT (K)	Part Number	Luminous Flux (lm)			
			Bin	Min.	Max.	
80+	2700	SPMWH1221FQ5GBW0SA	SA	111	121	
		SPMWH1221FQ5GBW0SB	SB	121	131	
	3000	SPMWH1221FQ5GBV0SA	SA	115	125	
		SPMWH1221FQ5GBV0SB	SB	125	135	
	3500	SPMWH1221FQ5GBU0SA	SA	117	127	
		SPMWH1221FQ5GBU0SB	SB	127	137	
	4000	SPMWH1221FQ5GBT0SA	SA	121	131	
		SPMWH1221FQ5GBT0SB	SB	131	141	
	5000	SPMWH1221FQ5GBR0SA	SA	123	133	
		SPMWH1221FQ5GBR0SB	SB	133	143	
	5700	SPMWH1221FQ5GBQ0SA	SA	122	132	
		SPMWH1221FQ5GBQ0SB	SB	132	142	
	6500	SPMWH1221FQ5GBP0SA	SA	121	131	
		SPMWH1221FQ5GBP0SB	SB	131	141	
	90+	2700	SPMWH1221FQ7GBW0SA	SA	93	103
			SPMWH1221FQ7GBW0SB	SB	103	113
3000		SPMWH1221FQ7GBV0SA	SA	97	107	
		SPMWH1221FQ7GBV0SB	SB	107	117	
3500		SPMWH1221FQ7GBU0SA	SA	98	108	
		SPMWH1221FQ7GBU0SB	SB	108	118	
4000		SPMWH1221FQ7GBT0SA	SA	102	112	
		SPMWH1221FQ7GBT0SB	SB	112	122	
5000		SPMWH1221FQ7GBR0SA	SA	103	113	
		SPMWH1221FQ7GBR0SB	SB	113	123	
5700		SPMWH1221FQ7GBQ0SA	SA	102	112	
		SPMWH1221FQ7GBQ0SB	SB	112	122	
6500		SPMWH1221FQ7GBP0SA	SA	102	112	
		SPMWH1221FQ7GBP0SB	SB	112	122	

* Color coordinates: Considering the color shift during high temp. operation, provided at hot temp. color shift coordinates.

LM283B +



Designed for better lm/\$

- 1W class mid power 9V LED
- Suitable for lamps & downlights
- Standard footprint: 2.8mm x 3.5mm

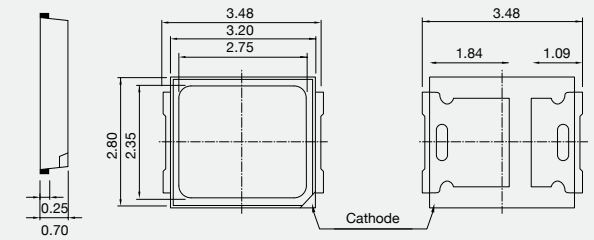

[100mA, 25°C]

CRI	CCT (K)	Part Number	Luminous Flux (lm)			
			Bin	Min.	Max.	
80+	2700	SPMWH1229AQ5SGW0SL	SL	112	122	
		SPMWH1229AQ5SGW0SM	SM	122	132	
	3000	SPMWH1229AQ5SGV0SL	SL	113	123	
		SPMWH1229AQ5SGV0SM	SM	123	133	
	3500	SPMWH1229AQ5SGU0SL	SL	117	127	
		SPMWH1229AQ5SGU0SM	SM	127	137	
	4000	SPMWH1229AQ5SGT0SL	SL	122	132	
		SPMWH1229AQ5SGT0SM	SM	132	142	
	5000	SPMWH1229AQ5SGR0SL	SL	124	134	
		SPMWH1229AQ5SGR0SM	SM	132	142	
	5700	SPMWH1229AQ5SGQ0SL	SL	123	133	
		SPMWH1229AQ5SGQ0SM	SM	132	142	
	6500	SPMWH1229AQ5SGP0SL	SL	122	132	
		SPMWH1229AQ5SGP0SM	SM	132	142	
	90+	2700	SPMWH1229AQ7SGW0SL	SL	93	103
			SPMWH1229AQ7SGW0SM	SM	103	113
3000		SPMWH1229AQ7SGV0SL	SL	94	104	
		SPMWH1229AQ7SGV0SM	SM	104	114	
3500		SPMWH1229AQ7SGU0SL	SL	98	108	
		SPMWH1229AQ7SGU0SM	SM	108	118	
4000		SPMWH1229AQ7SGT0SL	SL	102	112	
		SPMWH1229AQ7SGT0SM	SM	114	124	
5000		SPMWH1229AQ7SGR0SL	SL	104	114	
		SPMWH1229AQ7SGR0SM	SM	114	124	
5700		SPMWH1229AQ7SGQ0SL	SL	103	113	
		SPMWH1229AQ7SGQ0SM	SM	114	124	
6500		SPMWH1229AQ7SGP0SL	SL	102	112	
		SPMWH1229AQ7SGP0SM	SM	114	124	

* Color coordinates: Considering the color shift during high temp. operation, provided at hot temp. color shift coordinates.

LM284B +



Designed for better lm/\$

- 1W class mid power 12V LED
- Suitable for lamps & downlights
- Standard footprint: 2.8mm x 3.5mm

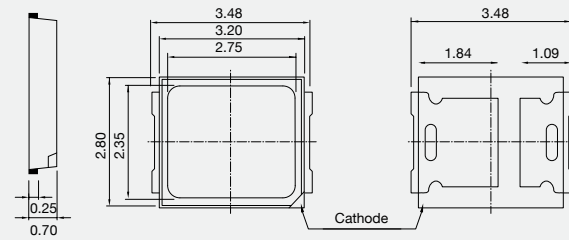

[75mA, 25°C]

CRI	CCT (K)	Part Number	Luminous Flux (lm)		
			Bin	Min.	Max.
80+	2700	SPMWH122C7Q5SHW0SB	SB	108	118
	3000	SPMWH122C7Q5SHV0SB	SB	110	120
	3500	SPMWH122C7Q5SHU0SB	SB	113	123
	4000	SPMWH122C7Q5SHT0SB	SB	115	125
	5000	SPMWH122C7Q5SHR0SB	SB	120	130
	5700	SPMWH122C7Q5SHQ0SB	SB	118	128
	6500	SPMWH122C7Q5SHP0SB	SB	115	125

* Color coordinates: Considering the color shift during high temp. operation, provided at hot temp. color shift coordinates.

LM286B +



Designed for better lm/\$

- 1W class mid power 18V LED
- Suitable for lamps & downlights
- Standard footprint: 2.8mm x 3.5mm

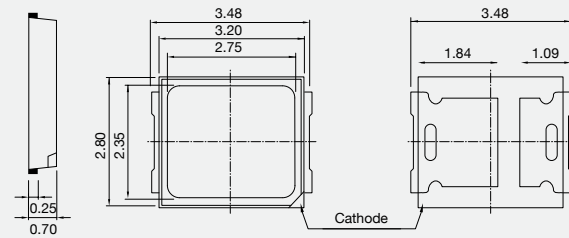

[50mA, 25°C]

CRI	CCT (K)	Part Number	Luminous Flux (lm)		
			Bin	Min.	Max.
80+	2700	SPMWH12245Q5W8W0SA	SA	100	110
		SPMWH12245Q5W8W0SB	SB	126	136
	3000	SPMWH12245Q5W8V0SA	SA	103	113
		SPMWH12245Q5W8V0SB	SB	128	138
	3500	SPMWH12245Q5W8U0SA	SA	107	117
		SPMWH12245Q5W8U0SB	SB	132	142
	4000	SPMWH12245Q5W8T0SA	SA	111	121
		SPMWH12245Q5W8T0SB	SB	138	148
	5000	SPMWH12245Q5W8R0SA	SA	114	124
		SPMWH12245Q5W8R0SB	SB	139	149
	5700	SPMWH12245Q5W8Q0SA	SA	112	122
		SPMWH12245Q5W8Q0SB	SB	137	147
	6500	SPMWH12245Q5W8Q0SA	SA	111	121
		SPMWH12245Q5W8Q0SB	SB	135	145
90+	2700	SPMWH12245Q7W8W0SA	SA	85	95
		SPMWH12245Q7W8W0SB	SB	105	115
	3000	SPMWH12245Q7W8V0SA	SA	88	98
		SPMWH12245Q7W8V0SB	SB	108	118
	3500	SPMWH12245Q7W8U0SA	SA	91	101
		SPMWH12245Q7W8U0SB	SB	110	120
	4000	SPMWH12245Q7W8T0SA	SA	95	105
		SPMWH12245Q7W8T0SB	SB	112	122
	5000	SPMWH12245Q7W8R0SA	SA	97	107
		SPMWH12245Q7W8R0SB	SB	114	124
	5700	SPMWH12245Q7W8Q0SA	SA	96	106
		SPMWH12245Q7W8Q0SB	SB	113	123
	6500	SPMWH12245Q7W8Q0SA	SA	95	105
		SPMWH12245Q7W8P0SB	SB	112	122

*Color coordinates: Considering the color shift during high temp. operation, provided at hot temp. color shift coordinates.

LM28CB +



Designed for better lm/\$

- 1W class mid power 36V LED
- Suitable for lamps
- Standard footprint: 2.8mm x 3.5mm

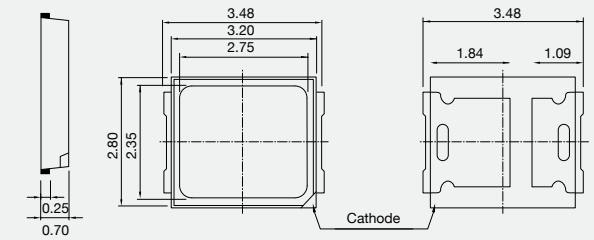

[30mA, 25°C]

CRI	CCT (K)	Part Number	Luminous Flux (lm)		
			Bin	Min.	Max.
80+	2700	SPMWH12253Q5SGW0SA	SA	125	135
	3000	SPMWH12253Q5SGV0SA	SA	128	138
	3500	SPMWH12253Q5SGU0SA	SA	132	142
	4000	SPMWH12253Q5SGT0SA	SA	136	146
	5000	SPMWH12253Q5SGR0SA	SA	139	149
	5700	SPMWH12253Q5SGQ0SA	SA	137	147
	6500	SPMWH12253Q5SGP0SA	SA	136	146

* Color coordinates: Considering the color shift during high temp. operation, provided at hot temp. color shift coordinates.

LM28JB +



Designed for better lm/\$

- 1W class mid power 54V LED
- Suitable for lamps
- Standard footprint: 2.8mm x 3.5mm

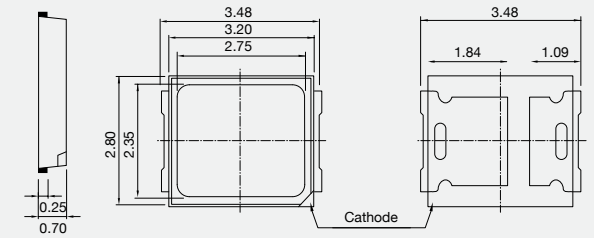

[20mA, 25°C]

CRI	CCT (K)	Part Number	Luminous Flux (lm)		
			Bin	Min.	Max.
80+	2700	SPMWH12262Q5SGW0SA	SA	125	135
	3000	SPMWH12262Q5SGV0SA	SA	128	138
	3500	SPMWH12262Q5SGU0SA	SA	132	142
	4000	SPMWH12262Q5SGT0SA	SA	136	146
	5000	SPMWH12262Q5SGR0SA	SA	139	149
	5700	SPMWH12262Q5SGQ0SA	SA	137	147
	6500	SPMWH12262Q5SGP0SA	SA	136	146

* Color coordinates: Considering the color shift during high temp. operation, provided at hot temp. color shift coordinates.



LM301B

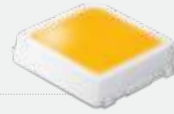

High performance, highest lm/W for fluorescent lamp replacement

- 0.2W, 3V mid-power LED
- Standard footprint: 3.0mm x 3.0mm

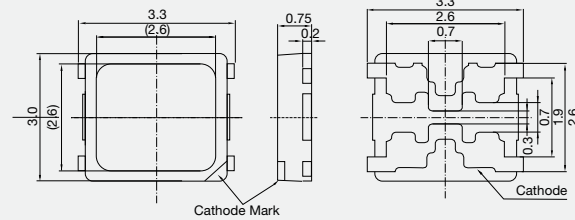

[65mA, 25°C]

CRI	CCT (K)	Part Number	Luminous Flux (lm)		
			Bin	Min.	Max.
70+	3000	SPMWH32AMD3XAV0S0	SJ	34	36
			SK	36	38
			SL	38	40
	3500	SPMWH32AMD3XAU0S0	SJ	34	36
			SK	36	38
			SL	38	40
	4000	SPMWH32AMD3XAT0S0	SK	36	38
			SL	38	40
			SM	40	42
	5000	SPMWH32AMD3XAR0S0	SK	36	38
			SL	38	40
			SM	40	42
80+	2700	SPMWH32AMD5XAW0S0	SH	32	34
			SJ	34	36
	3000	SPMWH32AMD5XAV0S0	SK	36	38
			SL	38	40
			SM	40	42
			SH	32	34
	3500	SPMWH32AMD5XAU0S0	SJ	34	36
			SK	36	38
			SL	38	40
			SM	40	42
	4000	SPMWH32AMD5XAT0S0	SJ	34	36
			SK	36	38
SL			38	40	
SM			40	42	
SH			32	34	
SL			38	40	
5000	SPMWH32AMD5XAR0S0	SK	36	38	
		SL	38	40	
		SM	40	42	
		SH	32	34	
		SL	38	40	
		SM	40	42	
5700	SPMWH32AMD5XAQ0S0	SK	36	38	
		SL	38	40	
		SM	40	42	
		SH	32	34	
		SL	38	40	
		SM	40	42	
6500	SPMWH32AMD5XAP0S0	SK	36	38	
		SL	38	40	
		SM	40	42	

CRI	CCT (K)	Part Number	Luminous Flux (lm)		
			Bin	Min.	Max.
90+	2700	SPMWH32AMD7XAW0S0	SF	28	30
			SG	30	32
	3000	SPMWH32AMD7XAV0S0	SF	28	30
			SG	30	32
	3500	SPMWH32AMD7XAU0S0	SG	30	32
			SH	32	34
	4000	SPMWH32AMD7XAT0S0	SG	30	32
			SH	32	34
	5000	SPMWH32AMD7XAR0S0	SG	30	32
			SH	32	34
	5700	SPMWH32AMD7XAQ0S0	SG	30	32
			SH	32	34
6500	SPMWH32AMD7XAP0S0	SG	30	32	
		SH	32	34	

LM301D

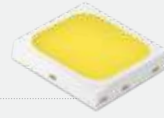

Balanced lm/\$ for ambient

- 0.2W, 3V mid power LED
- EMC resin for high reliability
- Standard footprint: 3.0mm x 3.0mm

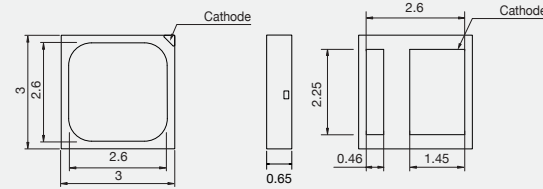

[65mA, 25°C]

CRI	CCT (K)	Part Number	Luminous Flux (lm)		
			Bin	Min.	Max.
70+	3000	SPMWH3326MS3WAV0SD	SD	34.5	37
	3500	SPMWH3326MS3WU0SD	SD	35	37.5
	4000	SPMWH3326MS3WAT0SD	SD	36	38.5
	5000	SPMWH3326MS3WAR0SD	SD	37	39.5
80+	2700	SPMWH3326MS5WAW0SD	SD	31.5	34.5
	3000	SPMWH3326MS5WAV0SD	SD	32.5	35.5
	3500	SPMWH3326MS5WU0SD	SD	33.5	36.5
	4000	SPMWH3326MS5WAY0SD	SD	34.5	37.5
	5000	SPMWH3326MS5WAR0SD	SD	35	38
	5700	SPMWH3326MS5WAQ0SD	SD	34.5	37.5
90+	6500	SPMWH3326MS5WAP0SD	SD	34.5	37.5
	2700	SPMWH3326MS7WAW0SD	SD	26.5	29
	3000	SPMWH3326MS7WAV0SD	SD	27.5	30
	3500	SPMWH3326MS7WU0SD	SD	28.5	31
	4000	SPMWH3326MS7WAY0SD	SD	29.5	32
	5000	SPMWH3326MS7WAR0SD	SD	30	32.5
	5700	SPMWH3326MS7WAQ0SD	SD	29	31.5
	6500	SPMWH3326MS7WAP0SD	SD	29	31.5

LM302D

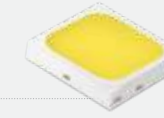

Balanced lm/\$ for ambient

- 0.9W, 6V mid power LED
- EMC resin for high reliability
- Standard footprint: 3.0mm x 3.0mm

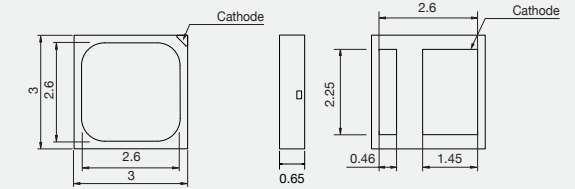

[65mA, 25°C]

CRI	CCT (K)	Part Number	Luminous Flux (lm)		
			Bin	Min.	Max.
70+	2700	SPMWH3327FS3GAW0SF	SF	145	155
	3000	SPMWH3327FS3GAV0SF	SF	150	160
	3500	SPMWH3327FS3GAU0SF	SF	152	162
	4000	SPMWH3327FS3GAT0SF	SF	158	168
	5000	SPMWH3327FS3GAR0SF	SF	158	168
80+	2700	SPMWH3327FS5GAW0SF	SF	129	139
	3000	SPMWH3327FS5GAV0SF	SF	134	144
	3500	SPMWH3327FS5GAU0SF	SF	139	149
	4000	SPMWH3327FS5GAT0SF	SF	142	152
	5000	SPMWH3327FS5GAR0SF	SF	144	154
	5700	SPMWH3327FS5GAQ0SF	SF	143	153
	6500	SPMWH3327FS5GAP0SF	SF	142	152
90+	2700	SPMWH3327FS7GAW0SF	SF	110	120
	3000	SPMWH3327FS7GAV0SF	SF	114	124
	3500	SPMWH3327FS7GAU0SF	SF	118	128
	4000	SPMWH3327FS7GAT0SF	SF	121	131
	5000	SPMWH3327FS7GAR0SF	SF	123	133
	5700	SPMWH3327FS7GAQ0SF	SF	122	132
	6500	SPMWH3327FS7GAP0SF	SF	121	131

LM301Z +



Balanced lm/\$ for highbay

- 0.2W, 3V mid power LED
- EMC resin for high reliability
- Standard footprint: 3.0mm x 3.0mm

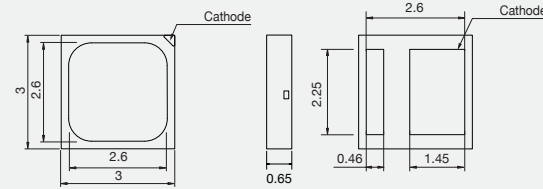

[65mA, 25°C]

CRI	CCT (K)	Part Number	Luminous Flux (lm)		
			Bin	Min.	Max.
70+	3000	SPMWH3326MP3WAV0S0	S0	33	36
	3500	SPMWH3326MP3WU0S0	S0	34	37
	4000	SPMWH3326MP3WAT0S0	S0	35	38
	5000	SPMWH3326MP3WAR0S0	S0	35	38
	5700	SPMWH3326MP3WAQ0S0	S0	35	38
	6500	SPMWH3326MP3WAP0S0	S0	34	37
80+	2700	SPMWH3326MP5WAW0S0	S0	30	33
	3000	SPMWH3326MP5WAV0S0	S0	31	34
	3500	SPMWH3326MP5WU0S0	S0	32	35
	4000	SPMWH3326MP5WAT0S0	S0	33	36
	5000	SPMWH3326MP5WAR0S0	S0	33.5	36.5
	5700	SPMWH3326MP5WAQ0S0	S0	33	36
90+	6500	SPMWH3326MP5WAP0S0	S0	33	36
	2700	SPMWH3326MP7WAW0S0	S0	25	28
	3000	SPMWH3326MP7WAV0S0	S0	26	29
	3500	SPMWH3326MP7WU0S0	S0	27	30
	4000	SPMWH3326MP7WAT0S0	S0	28	31
	5000	SPMWH3326MP7WAR0S0	S0	28	31
	5700	SPMWH3326MP7WAQ0S0	S0	28	31
	6500	SPMWH3326MP7WAP0S0	S0	28	31

LM302Z +

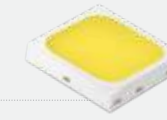

Balanced lm/\$ for highbay

- 0.9W, 6V mid-power LED
- EMC resin for high reliability
- Standard footprint: 3.0mm x 3.0mm

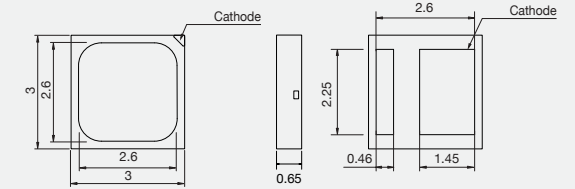

[65mA, 25°C]

CRI	CCT (K)	Part Number	Luminous Flux (lm)		
			Bin	Min.	Max.
70+	3000	SPMWH3326FP3GAV0S0	S0	139	149
	3500	SPMWH3326FP3GAU0S0	S0	141	151
	4000	SPMWH3326FP3GAT0S0	S0	144	154
	5000	SPMWH3326FP3GAR0S0	S0	146	156
	5700	SPMWH3326FP3GAQ0S0	S0	144	154
	6500	SPMWH3326FP3GAP0S0	S0	144	154
80+	2700	SPMWH3326FP5GAW0S0	S0	125	135
	3000	SPMWH3326FP5GAV0S0	S0	126	136
	3500	SPMWH3326FP5GAU0S0	S0	134	144
	4000	SPMWH3326FP5GAT0S0	S0	134	144
	5000	SPMWH3326FP5GAR0S0	S0	134	144
	5700	SPMWH3326FP5GAQ0S0	S0	134	144
90+	6500	SPMWH3326FP5GAP0S0	S0	132	142
	2700	SPMWH3326FP7GAW0S0	S0	103	113
	3000	SPMWH3326FP7GAV0S0	S0	107	117
	3500	SPMWH3326FP7GAU0S0	S0	114	124
	4000	SPMWH3326FP7GAT0S0	S0	116	126
	5000	SPMWH3326FP7GAR0S0	S0	116	126
	5700	SPMWH3326FP7GAQ0S0	S0	116	126
	6500	SPMWH3326FP7GAP0S0	S0	116	126

LM401BA +



IP guaranteed mid power 0.2W package for slim edge-lit panel applications

- 0.2W class mid power LED
- Suitable for slim edge-lit panel applications
- Standard footprint: 4.0mm x 1.4mm

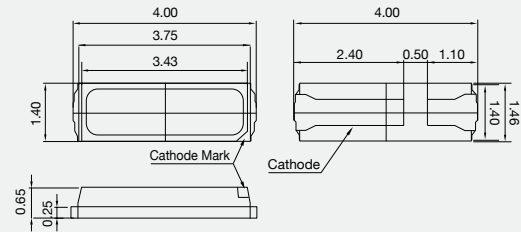

[60mA, 25°C]

CRI	CCT (K)	Part Number	Luminous Flux (lm)		
			Bin	Min.	Max.
80+	2700	SPMWH1410CD5WAW0S*	S1	21	23
			S2	23	25
			S3	25	27
			S4	27	29
	3000	SPMWH1410CD5WAV0S*	S1	21	23
			S2	23	25
			S3	25	27
			S4	27	29
	3500	SPMWH1410CD5WAW0S*	S1	22	24
			S2	24	26
			S3	26	28
			S4	28	30
	4000	SPMWH1410CD5WAT0S*	S1	23	25
			S2	25	27
			S3	27	29
			S4	29	31
	5000	SPMWH1410CD5WAR0S*	S1	24	26
			S2	26	28
			S3	28	30
			S4	30	32
	5700	SPMWH1410CD5WAQ0S*	S1	23	25
			S2	25	27
			S3	27	29
			S4	29	31
6500	SPMWH1410CD5WAP0S*	S1	23	25	
		S2	25	27	
		S3	27	29	
		S4	29	31	

LM401B +



IP guaranteed mid power 0.5W package for slim edge-lit panel applications

- 0.5W class mid power LED
- Suitable for slim edge-lit panel applications
- Standard footprint: 4.0mm x 1.4mm

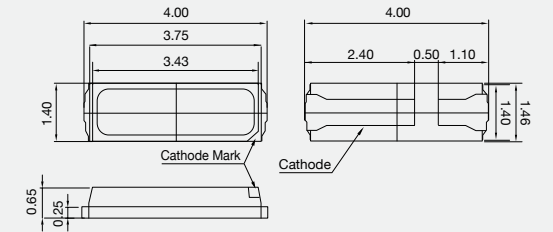

[120mA, 25°C]

CRI	CCT (K)	Part Number	Luminous Flux (lm)		
			Bin	Min.	Max.
80+	2700	SPMWH1410CD5WAW0S*	S2	40	44
			S3	44	48
			S4	48	52
			S5	52	56
	3000	SPMWH1410CD5WAV0S*	S2	40	44
			S3	44	48
			S4	48	52
			S5	52	56
	3500	SPMWH1410CD5WAW0S*	S2	40	44
			S3	44	48
			S4	48	52
			S5	52	56
	4000	SPMWH1410CD5WAT0S*	S2	44	48
			S3	48	52
			S4	52	56
			S5	56	60
	5000	SPMWH1410CD5WAR0S*	S2	46	50
			S3	50	54
			S4	54	58
			S5	58	62
	5700	SPMWH1410CD5WAQ0S*	S2	45	49
			S3	49	53
			S4	53	57
			S5	57	61
6500	SPMWH1410CD5WAP0S*	S2	44	48	
		S3	48	52	
		S4	52	56	
		S5	56	60	

LM561B +

Balanced lm/\$ for ambient

- 0.3 W class mid power LED
- High efficacy for distributed light
- Standard footprint: 5.6mm x 3.0mm

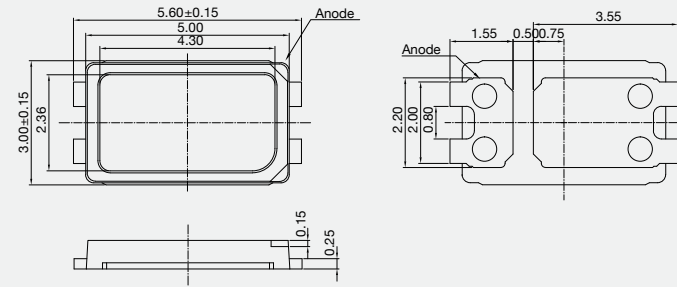

[65mA, 25°C]

CRI	CCT (K)	Part Number	Luminous Flux (lm)		
			Bin	Min.	Max.
70+	2700	SPMWHT541MP3WAW0S0	S5	32	34
			S6	34	36
			S7	36	38
	3000	SPMWHT541MP3WAV0S0	S5	32.5	34.5
			S6	34.5	36.5
			S7	36.5	38.5
	3500	SPMWHT541MP3WAW0S0	S5	33	35
			S6	35	37
			S7	37	39
	4000	SPMWHT541MP3WAT0S0	S5	34	35.8
			S6	35.8	38
			S7	38	40
	5000	SPMWHT541MP3WAR0S0	S4	33	35
			S5	35	37
			S6	37	39
80+	2700	SPMWHT541MP5WAW0S4	S4	30	32
			S5	32	34
			S6	30.5	32.5
	3000	SPMWHT541MP5WAV0S4	S4	30.5	32.5
			S5	32.5	34.5
			S6	34.5	36.5
	3500	SPMWHT541MP5WAW0S4	S4	31	33
			S5	33	35
			S6	35	37
	4000	SPMWHT541MP5WAT0S4	S4	32	34
			S5	34	36
			S6	36	38
	5000	SPMWHT541MP5WAR0S4	S4	33	35
			S5	35	37
			S6	37	39
5700	SPMWHT541MP5WAQ0S4	S4	32.5	34.5	
		S5	34.5	36.5	
		S6	36.5	38.5	
6500	SPMWHT541MP5WAP0S4	S4	32	34	
		S5	34	36	
		S6	36	38	

CRI	CCT (K)	Part Number	Luminous Flux (lm)		
			Bin	Min.	Max.
90+	2700	SPMWHT541MP7WAW0S0	S1	24	26
			S2	26	28
			S3	28	30
	3000	SPMWHT541MP7WAV0S0	S1	24.5	26.5
			S2	26.5	28.5
			S3	28.5	30.5
	3500	SPMWHT541MP7WAW0S0	S1	25	27
			S2	27	29
			S3	29	31
	4000	SPMWHT541MP7WAT0S0	S1	26	28
			S2	28	30
			S3	30	32
	5000	SPMWHT541MP7WAR0S0	S1	27	29
			S2	29	31
			S3	31	33
5700	SPMWHT541MP7WAQ0S0	S1	26.5	28.5	
		S2	28.5	30.5	
		S3	30.5	32.5	
6500	SPMWHT541MP7WAP0S0	S1	26	28	
		S2	28	30	
		S3	30	32	
90+ Premium Efficacy	2700	SPMWHT541MJ7WAW0S0	SB	26	28
			SC	28	30
			SB	27	29
	3000	SPMWHT541MJ7WAV0S0	SC	29	31
			SB	28	30
			SC	30	32
	3500	SPMWHT541MJ7WAW0S0	SB	28	30
			SC	30	32
			SB	29	31
	4000	SPMWHT541MJ7WAT0S0	SC	31	33
			SB	30	32
			SC	32	34
	5000	SPMWHT541MJ7WAR0S0	SB	30	32
			SC	32	34
			SB	29	31
5700	SPMWHT541MJ7WAQ0S0	SC	31	33	
		SB	29	31	
		SC	28	30	
6500	SPMWHT541MJ7WAP0S0	SB	28	30	
		SC	30	32	
		SB	28	30	



LM561C

Balanced lm/\$ for ambient

- 0.3W class mid power LED
- High efficacy for distributed light
- Standard footprint: 5.6mm x 3.0mm

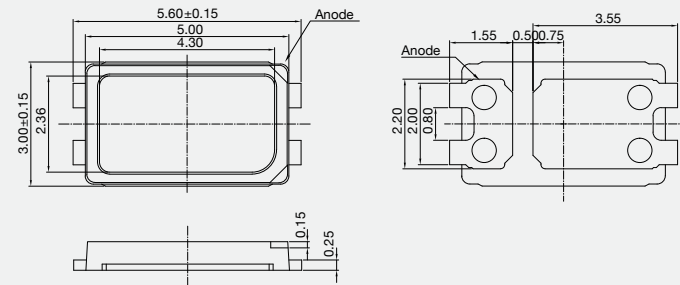

[65mA, 25°C]

CRI	CCT (K)	Part Number	Luminous Flux (lm)		
			Bin	Min.	Max.
70+	3000	SPMWHT541ML3XAV0S0	S5	32.5	34.5
			S6	34.5	36.5
			S7	36.5	38.5
	3500	SPMWHT541ML3XAU0S0	S5	33	35
			S6	35	37
			S7	37	39
	4000	SPMWHT541ML3XAT0S0	S5	34	36
			S6	36	38
			S7	38	40
	5000	SPMWHT541ML3XAR0S0	S5	35	37
			S6	37	39
			S7	39	41
80+	2700	SPMWHT541ML5XAW0S0	S4	30	32
			S5	32	34
	3000	SPMWHT541ML5XAV0S0	S5	32.5	34.5
			S6	34.5	36.5
	3500	SPMWHT541ML5XAU0S0	S5	33	35
			S6	35	37
	4000	SPMWHT541ML5XAT0S0	S5	34	36
			S6	36	38
	5000	SPMWHT541ML5XAR0S0	S5	35	37
			S6	37	39
	5700	SPMWHT541ML5XAQ0S0	S5	34.5	36.5
			S6	36.5	38.5
	6500	SPMWHT541ML5XAP0S0	S5	34	36
			S6	36	38

CRI	CCT (K)	Part Number	Luminous Flux (lm)		
			Bin	Min.	Max.
90+	2700	SPMWHT541ML7XAW0S0	S1	24	26
			S2	26	28
			S3	28	30
	3000	SPMWHT541ML7XAV0S0	S1	24.5	26.5
			S2	26.5	28.5
			S3	28.5	30.5
	3500	SPMWHT541ML7XAU0S0	S1	25	27
			S2	27	29
			S3	29	31
	4000	SPMWHT541ML7XAT0S0	S1	26	28
			S2	28	30
			S3	30	32
	5000	SPMWHT541ML7XAR0S0	S1	27	29
			S2	29	31
			S3	31	33
	5700	SPMWHT541ML7XAQ0S0	S1	26.5	28.5
			S2	28.5	30.5
			S3	30.5	32.5
6500	SPMWHT541ML7XAP0S0	S1	26	28	
		S2	28	30	
		S3	30	32	
90+ Premium Efficacy	2700	SPMWHT541MK7XAW0S0	SB	28	30
			SC	30	32
	3000	SPMWHT541MK7XAV0S0	SB	28	30
			SC	30	32
	3500	SPMWHT541MK7XAU0S0	SB	29	31
			SC	31	33
	4000	SPMWHT541MK7XAT0S0	SB	30	32
			SC	32	34
	5000	SPMWHT541MK7XAR0S0	SB	31	33
			SC	33	35
	5700	SPMWHT541MK7XAQ0S0	SB	30	32
			SC	32	34
6500	SPMWHT541MK7XAP0S0	SB	30	32	
		SC	32	34	

Linear Filament LEDs



Linear filament LED for decorative and general lighting bulbs

- Customized designs are available per customer request
- Length: 28, 38, 48, 58, 68mm
- Substrate: Ceramic
- CCT: 2200, 2400, 2700, 3000, 4000, 5000K
- CRI: 80+, 90+

LF312B

[25°C]

CRI	CCT (K)	Luminous Flux (lm)		IF (mA)	Substrate	1V Sorting	Part Number
		Min.	Max.				
80+	2700	110	120	10	Ceramic	-	SPMWH1FC31D52TWT1

LF423B

[25°C]

CRI	CCT (K)	Luminous Flux (lm)		IF (mA)	Substrate	1V Sorting	Part Number
		Min.	Max.				
80+	2700	220	240	20	Ceramic	-	SPMWH1FC42D52TWTU1

LF622B

[25°C]

CRI	CCT (K)	Luminous Flux (lm)		IF (mA)	Substrate	1V Sorting	Part Number
		Min.	Max.				
80+	2700	210	230	10	Ceramic	-	SPMWH1FC61D59RWT2

Flexible Filament LEDs



Flexible filament LED for decorative and general lighting bulbs

- Customized designs are available per customer request
- Length: 80, 148, 248, 308mm
- Substrate: Flexible PCB
- CCT: 2200, 2400, 2700, 3000, 4000, 5000K
- CRI: 80+, 90+

LFA26C

[25°C]

CRI	CCT (K)	Luminous Flux (lm)		IF (mA)	Substrate	1V Sorting	Part Number
		Min.	Max.				
84+	2200	260	290	20	FPC	-	SPMWH1FFA2D59RYTS2

LFB54C

[25°C]

CRI	CCT (K)	Luminous Flux (lm)		IF (mA)	Substrate	1V Sorting	Part Number
		Min.	Max.				
84+	2200	500	550	40	FPC	-	SPMWH1FFB4D59RYT42

LH351B

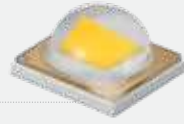

Cost effective solution for outdoor & directional lighting applications

- Operates at a maximum current of up to 1.5A
- Footprint: 3.5mm x 3.5mm

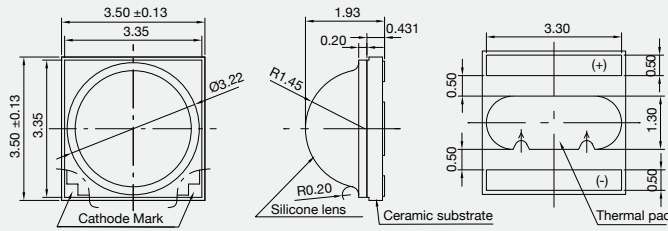

[350mA, 85°C]

CRI	CCT (K)	Part Number	Luminous Flux (lm)		
			Bin	Min.	Max.
70+	2200	SPHWH2L3D30CD4Y0K3	K1, M1, N1	130	160
		SPHWH2L3D30CD4W0K3	K1, M1, N1	130	160
	2700	SPHWH2L3D30CD4W0M3	M1, N1, P1	140	170
		SPHWH2L3D30CD4W0N3	N1, P1, Q1	150	180
	3000	SPHWH2L3D30CD4V0M3	M1, N1, P1	140	170
		SPHWH2L3D30CD4V0N3	N1, P1, Q1	150	180
	3500	SPHWH2L3D30CD4U0K3	K1, M1, N1	130	160
		SPHWH2L3D30CD4U0M3	M1, N1, P1	140	170
	4000	SPHWH2L3D30CD4U0N3	N1, P1, Q1	150	180
		SPHWH2L3D30CD4T0N3	N1, P1, Q1	150	180
	5000	SPHWH2L3D30CD4T0P3	P1, Q1, R1	160	190
		SPHWH2L3D30CD4T0Q2	Q1, R1	170	180
	5700	SPHWH2L3D30CD4T0Q3	Q1, R1, S1	170	200
		SPHWH2L3D30CD4R0M3	M1, N1, P1	140	170
	6500	SPHWH2L3D30CD4R0N3	N1, P1, Q1	150	180
		SPHWH2L3D30CD4R0P3	P1, Q1, R1	160	190
	2200	SPHWH2L3D30ED4Y0G3	G1, H1, J1	100	130
		2700	SPHWH2L3D30ED4W0J3	J1, K1, M1	120
	3000	SPHWH2L3D30ED4V0J3	J1, K1, M1	120	150
		3500	SPHWH2L3D30ED4V0K3	K1, M1, N1	130
	4000	SPHWH2L3D30ED4V0M3	M1, N1, P1	140	170
		5000	SPHWH2L3D30ED4V0N3	N1, P1, Q1	150
	5700	SPHWH2L3D30ED4T0M3	M1, N1, P1	140	170
		6000	SPHWH2L3D30ED4T0N3	N1, P1, Q1	150
6500	SPHWH2L3D30ED4T0K3	K1, M1, N1	130	160	
	2700	SPHWH2L3D30ED4T0M3	M1, N1, P1	140	170
3000	SPHWH2L3D30ED4T0N3	N1, P1, Q1	150	180	
	3500	SPHWH2L3D30ED4T0M3	M1, N1, P1	140	170
4000	SPHWH2L3D30ED4P0K3	K1, M1, N1	130	160	
	4500	SPHWH2L3D30ED4P0M3	M1, N1, P1	140	170
5000	SPHWH2L3D30ED4P0N3	N1, P1, Q1	150	180	
	5500	SPHWH2L3D30ED4P0M3	M1, N1, P1	140	170
6000	SPHWH2L3D30ED4P0K3	K1, M1, N1	130	160	
	6500	SPHWH2L3D30ED4P0M3	M1, N1, P1	140	170
7000	SPHWH2L3D30ED4P0N3	N1, P1, Q1	150	180	
	7500	SPHWH2L3D30ED4P0M3	M1, N1, P1	140	170
8000	SPHWH2L3D30ED4P0K3	K1, M1, N1	130	160	
	8500	SPHWH2L3D30ED4P0M3	M1, N1, P1	140	170
9000	SPHWH2L3D30ED4P0N3	N1, P1, Q1	150	180	
	9500	SPHWH2L3D30ED4P0M3	M1, N1, P1	140	170

LH351C

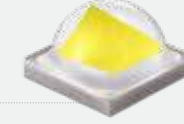

High performance suitable for street, high/low bay & sports lighting applications

- Operates at a maximum current of up to 2.0A
- Footprint: 3.5mm x 3.5mm

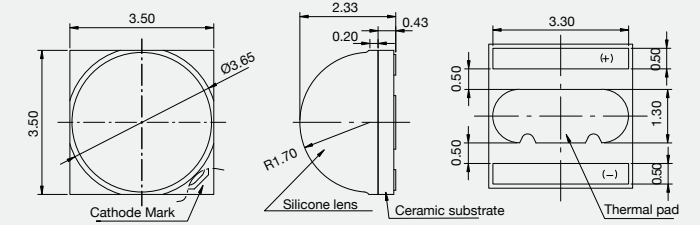

[700mA, 85°C]

CRI	CCT (K)	Part Number	Luminous Flux (lm)			
			Bin	Min.	Max.	
70+	2200	SPHWHTL3D50CE4Y0MF	MB, NB, PB	250	310	
		SPHWHTL3D50CE4W0MF	MB, NB, PB	250	310	
	2700	SPHWHTL3D50CE4W0NF	NB, PB, QB	270	330	
		SPHWHTL3D50CE4V0NF	NB, PB, QB	270	330	
	3000	SPHWHTL3D50CE4V0PF	PB, QB, RB	290	350	
		SPHWHTL3D50CE4V0QF	QB, RB, SB	310	370	
	3500	SPHWHTL3D50CE4U0PF	PB, QB, RB	290	350	
		SPHWHTL3D50CE4U0QF	QB, RB, SB	310	370	
	4000	SPHWHTL3D50CE4T0PF	PB, QB, RB	290	350	
		SPHWHTL3D50CE4T0QF	QB, RB, SB	310	370	
	5000	SPHWHTL3D50CE4T0RF	RB, SB, TB	330	390	
		SPHWHTL3D50CE4R0PF	PB, QB, RB	290	350	
	5700	SPHWHTL3D50CE4R0QF	QB, RB, SB	310	370	
		SPHWHTL3D50CE4Q0PF	PB, QB, RB	290	350	
	6500	SPHWHTL3D50CE4Q0QF	QB, RB, SB	310	370	
		SPHWHTL3D50CE4Q0RF	RB, SB, TB	330	390	
	75+	3000	SPHWHTL3D50DE4V0PF	PB, QB, RB	290	350
		3500	SPHWHTL3D50DE4U0PF	PB, QB, RB	290	350
	5000	SPHWHTL3D50DE4T0PF	PB, QB, RB	290	350	
		5700	SPHWHTL3D50DE4R0PF	PB, QB, RB	290	350
	2700	SPHWHTL3D50EE4W0MF	MB, NB, PB	250	310	
		3000	SPHWHTL3D50EE4V0NF	NB, PB, QB	270	330
	3500	SPHWHTL3D50EE4U0NF	NB, PB, QB	270	330	
		4000	SPHWHTL3D50EE4T0MF	MB, NB, PB	250	310
5000	SPHWHTL3D50EE4T0NF	NB, PB, QB	270	330		
	5700	SPHWHTL3D50EE4R0NF	NB, PB, QB	270	330	
7000	SPHWHTL3D50GE4W0HF	HB, JB, KB	190	250		
	7500	SPHWHTL3D50GE4W0JF	JB, KB, MB	210	270	
8000	3000	SPHWHTL3D50GE4V0JF	JB, KB, MB	210	270	
	3500	SPHWHTL3D50GE4U0JF	JB, KB, MB	210	270	
90+	4000	SPHWHTL3D50GE4T0JF	KB, MB, NB	230	290	
	4500	SPHWHTL3D50GE4T0KF	KB, MB, NB	230	290	
5000	SPHWHTL3D50GE4R0KF	KB, MB, NB	230	290		
	5500	SPHWHTL3D50GE4R0TMF	MB, NB, PB	250	310	
6000	SPHWHTL3D50GE4Q0KF	KB, MB, NB	230	290		
	6500	SPHWHTL3D50GE4Q0TMF	MB, NB, PB	250	310	

LH351D

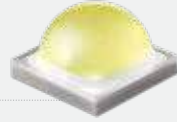

Best solution for high lumen output:
street & sports lighting applications

- Operates at a maximum current of up to 3.0A
- Footprint: 3.5mm x 3.5mm

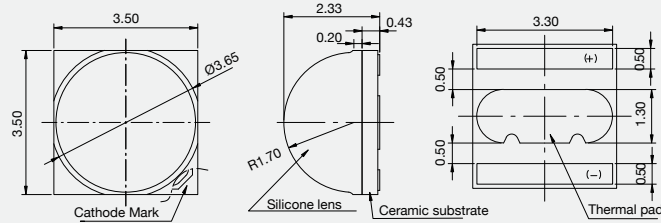

[1050mA, 85°C]

CRI	CCT (K)	Part Number	Luminous Flux (lm)			
			Bin	Min.	Max.	
70+	2700	SPHWHTL3DA0CF4W0S6	S2, T2, U2	380	420	
		SPHWHTL3DA0CF4W0T6	T2, U2, V2	400	440	
	3000	SPHWHTL3DA0CF4V0V6	V2, W2, Y2	440	480	
		SPHWHTL3DA0CF4V0W6	W2, Y2, Z2	460	500	
	3500	SPHWHTL3DA0CF4U0V6	V2, W2, Y2	440	480	
		SPHWHTL3DA0CF4U0W6	W2, Y2, Z2	460	500	
	4000	SPHWHTL3DA0CF4T0W6	W2, Y2, Z2	460	520	
		SPHWHTL3DA0CF4T0Y6	Y2, Z2, 12	480	540	
	5000	SPHWHTL3DA0CF4RTW6	W2, Y2, Z2	460	500	
		SPHWHTL3DA0CF4RTY6	Y2, Z2, 12	480	520	
	5700	SPHWHTL3DA0CF4RTZ6	Z2, 12, 22	500	540	
		SPHWHTL3DA0CF4QTV6	V2, W2, Y2	440	480	
	6500	SPHWHTL3DA0CF4QTW6	W2, Y2, Z2	460	500	
		SPHWHTL3DA0CF4QTY6	Y2, Z2, 12	480	520	
			SPHWHTL3DA0CF4PTW6	W2, Y2, Z2	460	500
			SPHWHTL3DA0CF4PTY6	Y2, Z2, 12	480	520

CRI	CCT (K)	Part Number	Luminous Flux (lm)		
			Bin	Min.	Max.
80+	2700	SPHWHTL3DA0EF4W0Q6	Q2, R2, S2	340	380
		SPHWHTL3DA0EF4W0R6	R2, S2, T2	360	400
	3000	SPHWHTL3DA0EF4V0R6	R2, S2, T2	360	400
		SPHWHTL3DA0EF4U0R6	R2, S2, T2	360	400
	3500	SPHWHTL3DA0EF4U0S6	S2, T2, U2	380	420
		SPHWHTL3DA0EF4T0S6	S2, T2, U2	380	420
	4000	SPHWHTL3DA0EF4T0T6	T2, U2, V2	400	440
		SPHWHTL3DA0EF4RTS6	S2, T2, U2	380	420
	5000	SPHWHTL3DA0EF4RTT6	T2, U2, V2	400	440
		SPHWHTL3DA0EF4RTU6	U2, V2, W2	420	460
	5300	SPHWHTL3DA0EF4QRT6	T2, U2, V2	400	440
		SPHWHTL3DA0EF4QRU6	U2, V2, W2	420	460
	5700	SPHWHTL3DA0EF4QTT6	T2, U2, V2	400	440
		SPHWHTL3DA0EF4QTU6	U2, V2, W2	420	460
	6000	SPHWHTL3DA0EF4PQT6	T2, U2, V2	400	440
		SPHWHTL3DA0EF4PQU6	U2, V2, W2	420	460
	6500	SPHWHTL3DA0EF4PTT6	T2, U2, V2	400	440
		SPHWHTL3DA0EF4PTU6	U2, V2, W2	420	460
90+	2700	SPHWHTL3DA0GF4W0M6	M2, N2, P2	280	320
		SPHWHTL3DA0GF4W0N6	N2, P2, Q2	300	340
	3000	SPHWHTL3DA0GF4V0N6	N2, P2, Q2	300	340
		SPHWHTL3DA0GF4V0P6	P2, Q2, R2	320	360
	3500	SPHWHTL3DA0GF4U0N6	N2, P2, Q2	300	340
		SPHWHTL3DA0GF4U0P6	P2, Q2, R2	320	360
	4000	SPHWHTL3DA0GF4T0P6	P2, Q2, R2	320	360
		SPHWHTL3DA0GF4T0Q6	Q2, R2, S2	340	380
	5000	SPHWHTL3DA0GF4RTR6	R2, S2, T2	360	400
		SPHWHTL3DA0GF4RTS6	S2, T2, U2	380	420
	6000	SPHWHTL3DA0GF4PQR6	R2, S2, T2	360	400
		SPHWHTL3DA0GF4PQS6	S2, T2, U2	380	420

LH502C

Designed for best lm/\$ with high luminous flux

- 6V high power LED
- EMC mold resin for high reliability
- Improved color quality
- Anti-sulfuriazion
- ESD Class 3A (max 8kV)
- Suitable for street light, high/low bay light & spot light
- Design flexible foorprint: 5.0mm × 5.0mm

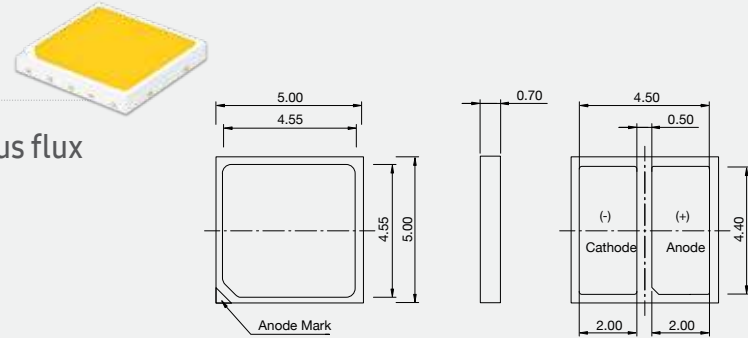

[640mA, 25°C]

CRI	CCT (K)	Part Number	Luminous Flux (lm)		
			Bin	Min.	Typ.
70+	2200	SPHWH1L5N603YEY★A2	A2	510	550
	2700	SPHWH1L5N603YEW★A2	A2	590	630
	3000	SPHWH1L5N603YEV★A2	A2	620	658
	3500	SPHWH1L5N603YEU★A2	A2	640	679
	4000	SPHWH1L5N603YET★A2	A2	660	700
	5000	SPHWH1L5N603YER★A2	A2	660	700
	5700	SPHWH1L5N603YEQ★A2	A2	650	693
	6500	SPHWH1L5N603YEP★A2	A2	640	686
80+	2200	SPHWH1L5N605YEY★A2	A2	430	480
	2700	SPHWH1L5N605YEW★A2	A2	540	580
	3000	SPHWH1L5N605YEV★A2	A2	570	605
	3500	SPHWH1L5N605YEU★A2	A2	580	625
	4000	SPHWH1L5N605YET★A2	A2	600	644
	5000	SPHWH1L5N605YER★A2	A2	600	644
	5700	SPHWH1L5N605YEQ★A2	A2	600	638
	6500	SPHWH1L5N605YEP★A2	A2	590	631
90+	2200	SPHWH1L5N607YEY★A2	A2	400	440
	2700	SPHWH1L5N607YEW★A2	A2	450	490
	3000	SPHWH1L5N607YEV★A2	A2	470	510
	3500	SPHWH1L5N607YEU★A2	A2	480	520
	4000	SPHWH1L5N607YET★A2	A2	490	530
	5000	SPHWH1L5N607YER★A2	A2	490	530
	5700	SPHWH1L5N607YEQ★A2	A2	490	530

★Can be replaced with '5' for the Mac5 color binning, or '3' for the Mac3 color binning

LH508C

Designed for best lm/\$ with high luminous flux

- 24V high power LED
- EMC mold resin for high reliability
- Improved color quality
- Anti-sulfuriazion
- ESD Class 3A (max 8kV)
- Suitable for street light, high/low bay light & spot light
- Design flexible foorprint: 5.0mm × 5.0mm

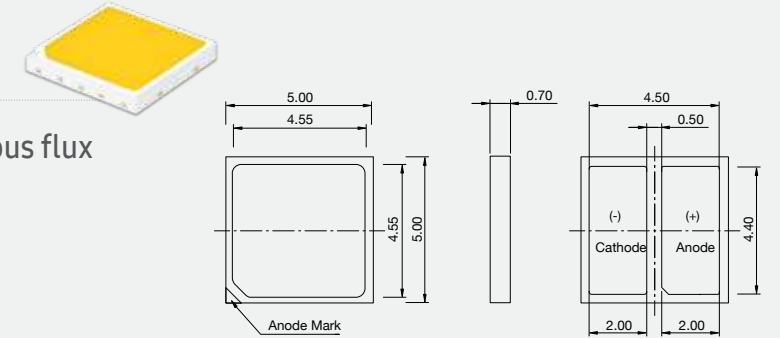

[160mA, 25°C]



CRI	CCT (K)	Part Number	Luminous Flux (lm)		
			Bin	Min.	Typ.
70+	2200	SPHWH1L5N603XEY★A2	A2	510	550
	2700	SPHWH1L5N603XEW★A2	A2	590	630
	3000	SPHWH1L5N603XEV★A2	A2	620	658
	3500	SPHWH1L5N603XEU★A2	A2	640	679
	4000	SPHWH1L5N603XET★A2	A2	660	700
	5000	SPHWH1L5N603XER★A2	A2	660	700
	5700	SPHWH1L5N603XEQ★A2	A2	650	693
	6500	SPHWH1L5N603XEP★A2	A2	640	686
80+	2200	SPHWH1L5N605XEY★A2	A2	430	480
	2700	SPHWH1L5N605XEW★A2	A2	540	580
	3000	SPHWH1L5N605XEV★A2	A2	570	605
	3500	SPHWH1L5N605XEU★A2	A2	580	625
	4000	SPHWH1L5N605XET★A2	A2	600	644
	5000	SPHWH1L5N605XER★A2	A2	600	644
	5700	SPHWH1L5N605XEQ★A2	A2	600	638
	6500	SPHWH1L5N605XEP★A2	A2	590	631
90+	2200	SPHWH1L5N607XEY★A2	A2	400	440
	2700	SPHWH1L5N607XEW★A2	A2	450	490
	3000	SPHWH1L5N607XEV★A2	A2	470	510
	3500	SPHWH1L5N607XEU★A2	A2	480	520
	4000	SPHWH1L5N607XET★A2	A2	490	530
	5000	SPHWH1L5N607XER★A2	A2	490	530
	5700	SPHWH1L5N607XEQ★A2	A2	490	530

★Can be replaced with '5' for the Mac5 color binning, or '3' for the Mac3 color binning

D Series Gen 3

Full line-up for various applications: MR/PAR, spotlights, downlights & high bay lights

- Industry-leading light efficacy in COB lineups
- Better thermal resistance than Gen 2
- High reliability satisfying DLC Premium standards
- Completed 6,000 hours of LM-80 testing

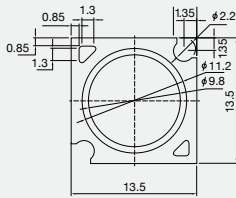
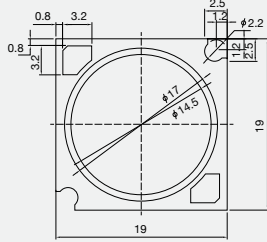
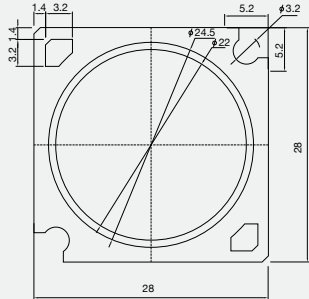
T _J =85°C	LC003D Gen 3	LC006D Gen 3	LC009D Gen 3	LC013D Gen 3	LC016D Gen 3	LC019D Gen 3	LC026D Gen 3	LC033D Gen 3	LC040D Gen 3	LC060D Gen 3	LC080D Gen 3
											
LES	9.8mm			14.5mm				22mm			
Typical	3.0W (90 mA)	6.1W (180 mA)	9.1W (270 mA)	12.2W (360 mA)	15.2W (450 mA)	18.3W (540 mA)	24.3W (720 mA)	30.4W (900 mA)	36.5W (1080 mA)	54.8W (1080 mA)	82.1W (1620 mA)
Max.	8.7W (230 mA)	17.4W (460 mA)	26.1W (690 mA)	34.8W (920 mA)	43.5W (1150 mA)	52.2W (1380 mA)	69.6W (1840 mA)	86.9W (2300 mA)	104.3W (2760 mA)	152.9W (2760 mA)	229.3W (4140 mA)
Dimension											
Size	13.5mm x 13.5mm			19mm x 19mm				28mm x 28mm			

Product	CRI	CCT (K)	Color Rank	Part Number	T _J =85°C		I _F (mA)	V _F (V)
					Luminous Flux Typ. (lm)	Luminous Efficacy Typ. (lm/W)		
LC003D Gen 3	2700	80+	MacAdam 1step	SPHWAHDNA25YZW1D3	475	156	90mA	33.8V
			MacAdam 2step	SPHWAHDNA25YZW2D3				
			MacAdam 3step	SPHWAHDNA25YZW3D3				
	3000	80+	MacAdam 1step	SPHWAHDNA25YZV1D3	499	164		
			MacAdam 2step	SPHWAHDNA25YZV2D3				
			MacAdam 3step	SPHWAHDNA25YZV3D3				
	3500	80+	MacAdam 1step	SPHWAHDNA25YZU1D3	514	169		
			MacAdam 2step	SPHWAHDNA25YZU2D3				
			MacAdam 3step	SPHWAHDNA25YZU3D3				
	4000	80+	MacAdam 1step	SPHWAHDNA25YZT1D3	524	172		
			MacAdam 2step	SPHWAHDNA25YZT2D3				
			MacAdam 3step	SPHWAHDNA25YZT3D3				
	5000	80+	MacAdam 2step	SPHWAHDNA25YZR2D3	529	174		
			MacAdam 3step	SPHWAHDNA25YZR3D3				
			MacAdam 2step	SPHWAHDNA25YZQ2D3				
	MacAdam 3step	SPHWAHDNA25YZQ3D3						
	6500	80+	MacAdam 2step	SPHWAHDNA25YZP2D3	524	172		
			MacAdam 3step	SPHWAHDNA25YZP3D3				
MacAdam 1step			SPHWAHDNA27YZW1D3	407			134	
MacAdam 2step	SPHWAHDNA27YZW2D3							
MacAdam 3step	SPHWAHDNA27YZW3D3							
3000	90+	MacAdam 1step	SPHWAHDNA27YZV1D3	428	141			
		MacAdam 2step	SPHWAHDNA27YZV2D3					
		MacAdam 3step	SPHWAHDNA27YZV3D3					
3500	90+	MacAdam 1step	SPHWAHDNA27YZU1D3	441	145			
		MacAdam 2step	SPHWAHDNA27YZU2D3					
		MacAdam 3step	SPHWAHDNA27YZU3D3					
4000	90+	MacAdam 1step	SPHWAHDNA27YZT1D3	450	148			
		MacAdam 2step	SPHWAHDNA27YZT2D3					
		MacAdam 3step	SPHWAHDNA27YZT3D3					
5000	90+	MacAdam 2step	SPHWAHDNA27YZR2D3	453	149			
		MacAdam 3step	SPHWAHDNA27YZR3D3					

Chip-on-Board LEDs

Package

Product	CRI	CCT (K)	Color Rank	Part Number	T _j =85°C		I _F (mA) V _F (V)
					Luminous Flux Typ. (lm)	Luminous Efficacy Typ. (lm/W)	
LC006D Gen 3	80+	2700	MacAdam 1step	SPHWAHDNB25YZW1D3	946	155	180mA 33.8V
			MacAdam 2step	SPHWAHDNB25YZW2D3			
			MacAdam 3step	SPHWAHDNB25YZW3D3			
	3000	MacAdam 1step	SPHWAHDNB25YZV1D3	994	163		
		MacAdam 2step	SPHWAHDNB25YZV2D3				
		MacAdam 3step	SPHWAHDNB25YZV3D3				
	3500	MacAdam 1step	SPHWAHDNB25YZU1D3	1023	168		
		MacAdam 2step	SPHWAHDNB25YZU2D3				
		MacAdam 3step	SPHWAHDNB25YZU3D3				
	4000	MacAdam 1step	SPHWAHDNB25YZT1D3	1043	171		
		MacAdam 2step	SPHWAHDNB25YZT2D3				
		MacAdam 3step	SPHWAHDNB25YZT3D3				
	5000	MacAdam 2step	SPHWAHDNB25YZR2D3	1052	173		
		MacAdam 3step	SPHWAHDNB25YZR3D3				
		MacAdam 2step	SPHWAHDNB25YZQ2D3			1052	
	MacAdam 3step	SPHWAHDNB25YZQ3D3					
	6500	MacAdam 2step	SPHWAHDNB25YZP2D3	1043	171		
		MacAdam 3step	SPHWAHDNB25YZP3D3				
		2700	MacAdam 1step			SPHWAHDNB27YZW1D3	
	MacAdam 2step		SPHWAHDNB27YZW2D3				
	MacAdam 3step		SPHWAHDNB27YZW3D3				
	3000	MacAdam 1step	SPHWAHDNB27YZV1D3	851	140		
		MacAdam 2step	SPHWAHDNB27YZV2D3				
		MacAdam 3step	SPHWAHDNB27YZV3D3				
3500	MacAdam 1step	SPHWAHDNB27YZU1D3	877	144			
	MacAdam 2step	SPHWAHDNB27YZU2D3					
	MacAdam 3step	SPHWAHDNB27YZU3D3					
4000	MacAdam 1step	SPHWAHDNB27YZT1D3	895	147			
	MacAdam 2step	SPHWAHDNB27YZT2D3					
	MacAdam 3step	SPHWAHDNB27YZT3D3					
5000	MacAdam 2step	SPHWAHDNB27YZR2D3	902	148			
	MacAdam 3step	SPHWAHDNB27YZR3D3					



LC006D Gen 3

Chip-on-Board LEDs

Package

Product	CRI	CCT (K)	Color Rank	Part Number	T _j =85°C		I _F (mA) V _F (V)
					Luminous Flux Typ. (lm)	Luminous Efficacy Typ. (lm/W)	
LC009D Gen 3	70+	3000	MacAdam 2step	SPHWAHDNC23YZV2D3	1594	174	270mA 33.8V
			MacAdam 3step	SPHWAHDNC23YZV3D3			
		4000	MacAdam 2step	SPHWAHDNC23YZT2D3	1624	177	
			MacAdam 3step	SPHWAHDNC23YZT3D3			
		5000	MacAdam 2step	SPHWAHDNC23YZR2D3	1653	180	
			MacAdam 3step	SPHWAHDNC23YZR3D3			
	80+	2700	MacAdam 1step	SPHWAHDNC25YZW1D3	1405	154	
			MacAdam 2step	SPHWAHDNC25YZW2D3			
		3000	MacAdam 1step	SPHWAHDNC25YZV1D3	1476	162	
			MacAdam 2step	SPHWAHDNC25YZV2D3			
		3500	MacAdam 1step	SPHWAHDNC25YZU1D3	1519	166	
			MacAdam 2step	SPHWAHDNC25YZU2D3			
	90+	4000	MacAdam 1step	SPHWAHDNC25YZT1D3	1550	170	
			MacAdam 2step	SPHWAHDNC25YZT2D3			
		5000	MacAdam 1step	SPHWAHDNC25YZR2D3	1563	171	
			MacAdam 3step	SPHWAHDNC25YZR3D3			
		5700	MacAdam 2step	SPHWAHDNC25YZQ2D3	1563	171	
			MacAdam 3step	SPHWAHDNC25YZQ3D3			
	90+	6500	MacAdam 2step	SPHWAHDNC25YZP2D3	1550	170	
			MacAdam 3step	SPHWAHDNC25YZP3D3			
		2700	MacAdam 1step	SPHWAHDNC27YZW1D3	1202	132	
			MacAdam 2step	SPHWAHDNC27YZW2D3			
		3000	MacAdam 1step	SPHWAHDNC27YZV1D3	1264	139	
			MacAdam 2step	SPHWAHDNC27YZV2D3			
3500	MacAdam 1step	SPHWAHDNC27YZU1D3	1302	143			
	MacAdam 2step	SPHWAHDNC27YZU2D3					
90+	4000	MacAdam 1step	SPHWAHDNC27YZT1D3	1329	146		
		MacAdam 2step	SPHWAHDNC27YZT2D3				
	5000	MacAdam 1step	SPHWAHDNC27YZU1D3	1340	147		
		MacAdam 2step	SPHWAHDNC27YZR2D3				
	5000	MacAdam 2step	SPHWAHDNC27YZR2D3	1340	147		
		MacAdam 3step	SPHWAHDNC27YZR3D3				



LC009D Gen 3

Chip-on-Board LEDs

Package

Product	CRI	CCT (K)	Color Rank	Part Number	T _J =85°C		I _F (mA) V _F (V)
					Luminous Flux Typ. (lm)	Luminous Efficacy Typ. (lm/W)	
LC013D Gen 3	70+	3000	MacAdam 2step	SPHWAHDND23YZV2D3	2094	171	360mA 33.8V
			MacAdam 3step	SPHWAHDND23YZV3D3			
		4000	MacAdam 2step	SPHWAHDND23YZT2D3	2133	174	
			MacAdam 3step	SPHWAHDND23YZT3D3			
		5000	MacAdam 2step	SPHWAHDND23YZR2D3	2171	177	
			MacAdam 3step	SPHWAHDND23YZR3D3			
	2700	MacAdam 1step	SPHWAHDND25YZW1D3	1845	152		
		MacAdam 2step	SPHWAHDND25YZW2D3				
		MacAdam 3step	SPHWAHDND25YZW3D3				
	3000	MacAdam 1step	SPHWAHDND25YZV1D3	1939	159		
		MacAdam 2step	SPHWAHDND25YZV2D3				
		MacAdam 3step	SPHWAHDND25YZV3D3				
	3500	MacAdam 1step	SPHWAHDND25YZU1D3	1996	164		
		MacAdam 2step	SPHWAHDND25YZU2D3				
		MacAdam 3step	SPHWAHDND25YZU3D3				
	80+	4000	MacAdam 1step	SPHWAHDND25YZT1D3	2036	167	
			MacAdam 2step	SPHWAHDND25YZT2D3			
			MacAdam 3step	SPHWAHDND25YZT3D3			
		5000	MacAdam 2step	SPHWAHDND25YZR2D3	2053	169	
			MacAdam 3step	SPHWAHDND25YZR3D3			
			MacAdam 2step	SPHWAHDND25YZQ2D3			
	MacAdam 3step	SPHWAHDND25YZQ3D3					
	6500	MacAdam 2step	SPHWAHDND25YZP2D3	2036	167		
		MacAdam 3step	SPHWAHDND25YZP3D3				
MacAdam 1step		SPHWAHDND27YZW1D3	1579			130	
2700	MacAdam 2step	SPHWAHDND27YZW2D3					
	MacAdam 3step	SPHWAHDND27YZW3D3					
	3000	MacAdam 1step	SPHWAHDND27YZV1D3	1661	137		
MacAdam 2step		SPHWAHDND27YZV2D3					
MacAdam 3step		SPHWAHDND27YZV3D3					
90+	3500	MacAdam 1step	SPHWAHDND27YZU1D3	1710	141		
		MacAdam 2step	SPHWAHDND27YZU2D3				
		MacAdam 3step	SPHWAHDND27YZU3D3				
	4000	MacAdam 1step	SPHWAHDND27YZT1D3	1745	143		
		MacAdam 2step	SPHWAHDND27YZT2D3				
		MacAdam 3step	SPHWAHDND27YZT3D3				
5000	MacAdam 2step	SPHWAHDND37YZR2D3	1760	145			
	MacAdam 3step	SPHWAHDND37YZR3D3					



Chip-on-Board LEDs

Package

Product	CRI	CCT (K)	Color Rank	Part Number	T _J =85°C		I _F (mA) V _F (V)
					Luminous Flux Typ. (lm)	Luminous Efficacy Typ. (lm/W)	
LC016D Gen 3	70+	3000	MacAdam 2step	SPHWAHDNE23YZV2D3	2697	176	450mA 33.8V
			MacAdam 3step	SPHWAHDNE23YZV3D3			
		4000	MacAdam 2step	SPHWAHDNE23YZT2D3	2747	180	
			MacAdam 3step	SPHWAHDNE23YZT3D3			
		5000	MacAdam 2step	SPHWAHDNE23YZR2D3	2797	183	
			MacAdam 3step	SPHWAHDNE23YZR3D3			
	2700	MacAdam 1step	SPHWAHDNE25YZW1D3	2376	156		
		MacAdam 2step	SPHWAHDNE25YZW2D3				
		MacAdam 3step	SPHWAHDNE25YZW3D3				
	3000	MacAdam 1step	SPHWAHDNE25YZV1D3	2497	164		
		MacAdam 2step	SPHWAHDNE25YZV2D3				
		MacAdam 3step	SPHWAHDNE25YZV3D3				
	3500	MacAdam 1step	SPHWAHDNE25YZU1D3	2570	169		
		MacAdam 2step	SPHWAHDNE25YZU2D3				
		MacAdam 3step	SPHWAHDNE25YZU3D3				
	80+	4000	MacAdam 1step	SPHWAHDNE25YZT1D3	2622	172	
			MacAdam 2step	SPHWAHDNE25YZT2D3			
			MacAdam 3step	SPHWAHDNE25YZT3D3			
		5000	MacAdam 2step	SPHWAHDNE25YZR2D3	2644	174	
			MacAdam 3step	SPHWAHDNE25YZR3D3			
			MacAdam 2step	SPHWAHDNE25YZQ2D3			
	MacAdam 3step	SPHWAHDNE25YZQ3D3					
	6500	MacAdam 2step	SPHWAHDNE25YZP2D3	2622	172		
		MacAdam 3step	SPHWAHDNE25YZP3D3				
MacAdam 1step		SPHWAHDNE27YZW1D3	2033			134	
2700	MacAdam 2step	SPHWAHDNE27YZW2D3					
	MacAdam 3step	SPHWAHDNE27YZW3D3					
	3000	MacAdam 1step	SPHWAHDNE27YZV1D3	2139	141		
MacAdam 2step		SPHWAHDNE27YZV2D3					
MacAdam 3step		SPHWAHDNE27YZV3D3					
90+	3500	MacAdam 1step	SPHWAHDNE27YZU1D3	2203	145		
		MacAdam 2step	SPHWAHDNE27YZU2D3				
		MacAdam 3step	SPHWAHDNE27YZU3D3				
	4000	MacAdam 1step	SPHWAHDNE27YZT1D3	2248	148		
		MacAdam 2step	SPHWAHDNE27YZT2D3				
		MacAdam 3step	SPHWAHDNE27YZT3D3				
5000	MacAdam 1step	SPHWAHDNE27YZR1D3	2267	149			
	MacAdam 3step	SPHWAHDNE27YZR3D3					



Chip-on-Board LEDs

Package

Product	CRI	CCT (K)	Color Rank	Part Number	T _J =85°C		I _F (mA) V _F (V)
					Luminous Flux Typ. (lm)	Luminous Efficacy Typ. (lm/W)	
 LC019D Gen 3	70+	3000	MacAdam 2step	SPHWAHDNF23YZV2D3	3220	175	540mA 33.8V
			MacAdam 3step	SPHWAHDNF23YZV3D3			
		4000	MacAdam 2step	SPHWAHDNF23YZT2D3	3280	179	
			MacAdam 3step	SPHWAHDNF23YZT3D3			
		5000	MacAdam 2step	SPHWAHDNF23YZR2D3	3339	182	
			MacAdam 3step	SPHWAHDNF23YZR3D3			
	2700	MacAdam 1step	SPHWAHDNF25YZW1D3	2837	155		
		MacAdam 2step	SPHWAHDNF25YZW2D3				
		MacAdam 3step	SPHWAHDNF25YZW3D3				
	3000	MacAdam 1step	SPHWAHDNF25YZV1D3	2982	163		
		MacAdam 2step	SPHWAHDNF25YZV2D3				
		MacAdam 3step	SPHWAHDNF25YZV3D3				
	3500	MacAdam 1step	SPHWAHDNF25YZU1D3	3069	168		
		MacAdam 2step	SPHWAHDNF25YZU2D3				
		MacAdam 3step	SPHWAHDNF25YZU3D3				
	80+	4000	MacAdam 1step	SPHWAHDNF25YZT1D3	3130	171	
			MacAdam 2step	SPHWAHDNF25YZT2D3			
			MacAdam 3step	SPHWAHDNF25YZT3D3			
		5000	MacAdam 2step	SPHWAHDNF25YZR2D3	3157	173	
			MacAdam 3step	SPHWAHDNF25YZR3D3			
		5700	MacAdam 2step	SPHWAHDNF25YZQ2D3	3157	173	
	MacAdam 3step		SPHWAHDNF25YZQ3D3				
	6500	MacAdam 2step	SPHWAHDNF25YZP2D3	3130	171		
		MacAdam 3step	SPHWAHDNF25YZP3D3				
90+	2700	MacAdam 1step	SPHWAHDNF27YZW1D3	2428	133		
		MacAdam 2step	SPHWAHDNF27YZW2D3				
		MacAdam 3step	SPHWAHDNF27YZW3D3				
	3000	MacAdam 1step	SPHWAHDNF27YZV1D3	2554	140		
		MacAdam 2step	SPHWAHDNF27YZV2D3				
		MacAdam 3step	SPHWAHDNF27YZV3D3				
	3500	MacAdam 1step	SPHWAHDNF27YZU1D3	2630	144		
		MacAdam 2step	SPHWAHDNF27YZU2D3				
		MacAdam 3step	SPHWAHDNF27YZU3D3				
	4000	MacAdam 1step	SPHWAHDNF27YZT1D3	2684	147		
		MacAdam 2step	SPHWAHDNF27YZT2D3				
		MacAdam 3step	SPHWAHDNF27YZT3D3				
5000	MacAdam 2step	SPHWAHDNF27YZR2D3	2707	148			
	MacAdam 3step	SPHWAHDNF27YZR3D3					

Chip-on-Board LEDs

Package

Product	CRI	CCT (K)	Color Rank	Part Number	T _J =85°C		I _F (mA) V _F (V)
					Luminous Flux Typ. (lm)	Luminous Efficacy Typ. (lm/W)	
 LC026D Gen 3	70+	3000	MacAdam 2step	SPHWAHDNG23YZV2D3	4230	174	720mA 33.8V
			MacAdam 3step	SPHWAHDNG23YZV3D3			
		4000	MacAdam 2step	SPHWAHDNG23YZT2D3	4308	177	
			MacAdam 3step	SPHWAHDNG23YZT3D3			
		5000	MacAdam 2step	SPHWAHDNG23YZR2D3	4387	180	
			MacAdam 3step	SPHWAHDNG23YZR3D3			
	2700	MacAdam 1step	SPHWAHDNG25YZW1D3	3727	153		
		MacAdam 2step	SPHWAHDNG25YZW2D3				
		MacAdam 3step	SPHWAHDNG25YZW3D3				
	3000	MacAdam 1step	SPHWAHDNG25YZV1D3	3917	161		
		MacAdam 2step	SPHWAHDNG25YZV2D3				
		MacAdam 3step	SPHWAHDNG25YZV3D3				
	3500	MacAdam 1step	SPHWAHDNG25YZU1D3	4032	166		
		MacAdam 2step	SPHWAHDNG25YZU2D3				
		MacAdam 3step	SPHWAHDNG25YZU3D3				
	80+	4000	MacAdam 1step	SPHWAHDNG25YZT1D3	4112	169	
			MacAdam 2step	SPHWAHDNG25YZT2D3			
			MacAdam 3step	SPHWAHDNG25YZT3D3			
		5000	MacAdam 2step	SPHWAHDNG25YZR2D3	4147	170	
			MacAdam 3step	SPHWAHDNG25YZR3D3			
		5700	MacAdam 2step	SPHWAHDNG25YZQ2D3	4147	170	
	MacAdam 3step		SPHWAHDNG25YZQ3D3				
	6500	MacAdam 2step	SPHWAHDNG25YZP2D3	4112	169		
		MacAdam 3step	SPHWAHDNG25YZP3D3				
90+	2700	MacAdam 1step	SPHWAHDNG27YZW1D3	3190	131		
		MacAdam 2step	SPHWAHDNG27YZW2D3				
		MacAdam 3step	SPHWAHDNG27YZW3D3				
	3000	MacAdam 1step	SPHWAHDNG27YZV1D3	3355	138		
		MacAdam 2step	SPHWAHDNG27YZV2D3				
		MacAdam 3step	SPHWAHDNG27YZV3D3				
	3500	MacAdam 1step	SPHWAHDNG27YZU1D3	3455	142		
		MacAdam 2step	SPHWAHDNG27YZU2D3				
		MacAdam 3step	SPHWAHDNG27YZU3D3				
	4000	MacAdam 1step	SPHWAHDNG27YZT1D3	3526	145		
		MacAdam 2step	SPHWAHDNG27YZT2D3				
		MacAdam 3step	SPHWAHDNG27YZT3D3				
5000	MacAdam 2step	SPHWAHDNG27YZR2D3	3556	146			
	MacAdam 3step	SPHWAHDNG27YZR3D3					

Chip-on-Board LEDs

Package

Product	CRI	CCT (K)	Color Rank	Part Number	T _J =85°C		I _F (mA) V _F (V)
					Luminous Flux Typ. (lm)	Luminous Efficacy Typ. (lm/W)	
LC033D Gen 3	70+	3000	MacAdam 2step	SPHWAHDNH23YZV2D3	5235	172	900mA 33.8V
			MacAdam 3step	SPHWAHDNH23YZV3D3			
		4000	MacAdam 2step	SPHWAHDNH23YZT2D3	5332	175	
			MacAdam 3step	SPHWAHDNH23YZT3D3			
		5000	MacAdam 2step	SPHWAHDNH23YZR2D3	5429	178	
			MacAdam 3step	SPHWAHDNH23YZR3D3			
	2700	MacAdam 1step	SPHWAHDNH25YZW1D3	4612	152		
		MacAdam 2step	SPHWAHDNH25YZW2D3				
		MacAdam 3step	SPHWAHDNH25YZW3D3				
	3000	MacAdam 1step	SPHWAHDNH25YZV1D3	4847	159		
		MacAdam 2step	SPHWAHDNH25YZV2D3				
		MacAdam 3step	SPHWAHDNH25YZV3D3				
	3500	MacAdam 1step	SPHWAHDNH25YZU1D3	4989	164		
		MacAdam 2step	SPHWAHDNH25YZU2D3				
		MacAdam 3step	SPHWAHDNH25YZU3D3				
	80+	4000	MacAdam 1step	SPHWAHDNH25YZT1D3	5089	167	
			MacAdam 2step	SPHWAHDNH25YZT2D3			
			MacAdam 3step	SPHWAHDNH25YZT3D3			
		5000	MacAdam 2step	SPHWAHDNH25YZR2D3	5132	169	
			MacAdam 3step	SPHWAHDNH25YZR3D3			
			MacAdam 2step	SPHWAHDNH25YZQ2D3			
	MacAdam 3step	SPHWAHDNH25YZQ3D3					
	6500	MacAdam 2step	SPHWAHDNH25YZP2D3	5089	167		
		MacAdam 3step	SPHWAHDNH25YZP3D3				
MacAdam 1step		SPHWAHDNH27YZW1D3	3947			130	
2700	MacAdam 2step	SPHWAHDNH27YZW2D3					
	MacAdam 3step	SPHWAHDNH27YZW3D3					
	3000	MacAdam 1step	SPHWAHDNH27YZV1D3	4152	136		
MacAdam 2step		SPHWAHDNH27YZV2D3					
MacAdam 3step		SPHWAHDNH27YZV3D3					
90+	3500	MacAdam 1step	SPHWAHDNH27YZU1D3	4276	141		
		MacAdam 2step	SPHWAHDNH27YZU2D3				
		MacAdam 3step	SPHWAHDNH27YZU3D3				
	4000	MacAdam 1step	SPHWAHDNH27YZT1D3	4364	143		
		MacAdam 2step	SPHWAHDNH27YZT2D3				
		MacAdam 3step	SPHWAHDNH27YZT3D3				
5000	MacAdam 2step	SPHWAHDNH27YZR2D3	4401	145			
	MacAdam 3step	SPHWAHDNH27YZR3D3					



LC033D Gen 3

Chip-on-Board LEDs

Package

Product	CRI	CCT (K)	Color Rank	Part Number	T _J =85°C		I _F (mA) V _F (V)
					Luminous Flux Typ. (lm)	Luminous Efficacy Typ. (lm/W)	
LC040D Gen 3	70+	3000	MacAdam 2step	SPHWAHDNK23YZV2D3	6440	176	1080mA 33.8V
			MacAdam 3step	SPHWAHDNK23YZV3D3			
		4000	MacAdam 2step	SPHWAHDNK23YZT2D3	6560	180	
			MacAdam 3step	SPHWAHDNK23YZT3D3			
		5000	MacAdam 2step	SPHWAHDNK23YZR2D3	6679	183	
			MacAdam 3step	SPHWAHDNK23YZR3D3			
	2700	MacAdam 1step	SPHWAHDNK25YZW1D3	5675	155		
		MacAdam 2step	SPHWAHDNK25YZW2D3				
		MacAdam 3step	SPHWAHDNK25YZW3D3				
	3000	MacAdam 1step	SPHWAHDNK25YZV1D3	5963	163		
		MacAdam 2step	SPHWAHDNK25YZV2D3				
		MacAdam 3step	SPHWAHDNK25YZV3D3				
	3500	MacAdam 1step	SPHWAHDNK25YZU1D3	6138	168		
		MacAdam 2step	SPHWAHDNK25YZU2D3				
		MacAdam 3step	SPHWAHDNK25YZU3D3				
	80+	4000	MacAdam 1step	SPHWAHDNK25YZT1D3	6261	172	
			MacAdam 2step	SPHWAHDNK25YZT2D3			
			MacAdam 3step	SPHWAHDNK25YZT3D3			
		5000	MacAdam 2step	SPHWAHDNK25YZR2D3	6313	173	
			MacAdam 3step	SPHWAHDNK25YZR3D3			
			MacAdam 2step	SPHWAHDNK25YZQ2D3			
	MacAdam 3step	SPHWAHDNK25YZQ3D3					
	6500	MacAdam 2step	SPHWAHDNK25YZP2D3	6261	172		
		MacAdam 3step	SPHWAHDNK25YZP3D3				
MacAdam 1step		SPHWAHDNK27YZW1D3	4856			133	
2700	MacAdam 2step	SPHWAHDNK27YZW2D3					
	MacAdam 3step	SPHWAHDNK27YZW3D3					
	3000	MacAdam 1step	SPHWAHDNK27YZV1D3	5108	140		
MacAdam 2step		SPHWAHDNK27YZV2D3					
MacAdam 3step		SPHWAHDNK27YZV3D3					
90+	3500	MacAdam 1step	SPHWAHDNK27YZU1D3	5260	144		
		MacAdam 2step	SPHWAHDNK27YZU2D3				
		MacAdam 3step	SPHWAHDNK27YZU3D3				
	4000	MacAdam 1step	SPHWAHDNK27YZT1D3	5369	147		
		MacAdam 2step	SPHWAHDNK27YZT2D3				
		MacAdam 3step	SPHWAHDNK27YZT3D3				
5000	MacAdam 2step	SPHWAHDNK27YZR2D3	5415	148			
	MacAdam 3step	SPHWAHDNK27YZR3D3					



LC040D Gen 3

Chip-on-Board LEDs

Package

Product	CRI	CCT (K)	Color Rank	Part Number	T _j =85°C		I _F (mA) V _F (V)
					Luminous Flux Typ. (lm)	Luminous Efficacy Typ. (lm/W)	
LC060D Gen 3	70+	3000	MacAdam 2step	SPHWAHDNL231ZV2D3	9518	174	1080mA 50.7V
			MacAdam 3step	SPHWAHDNL231ZV3D3			
		4000	MacAdam 2step	SPHWAHDNL231ZT2D3	9694	177	
			MacAdam 3step	SPHWAHDNL231ZT3D3			
		5000	MacAdam 2step	SPHWAHDNL231ZR2D3	9870	180	
			MacAdam 3step	SPHWAHDNL231ZR3D3			
	2700	MacAdam 1step	SPHWAHDNL251ZW1D3	8386	153		
		MacAdam 2step	SPHWAHDNL251ZW2D3				
		MacAdam 3step	SPHWAHDNL251ZW3D3				
	80+	3000	MacAdam 1step	SPHWAHDNL251ZV1D3	8813	161	
			MacAdam 2step	SPHWAHDNL251ZV2D3			
		3500	MacAdam 3step	SPHWAHDNL251ZV3D3	9071	166	
MacAdam 1step			SPHWAHDNL251ZU1D3				
4000		MacAdam 2step	SPHWAHDNL251ZU2D3	9253	169		
		MacAdam 3step	SPHWAHDNL251ZU3D3				
	MacAdam 1step	SPHWAHDNL251ZT1D3					
90+	5000	MacAdam 2step	SPHWAHDNL251ZT2D3	9253	170		
		MacAdam 3step	SPHWAHDNL251ZT3D3				
	5700	MacAdam 2step	SPHWAHDNL251ZQ2D3	9330	170		
		MacAdam 3step	SPHWAHDNL251ZQ3D3				
	6500	MacAdam 2step	SPHWAHDNL251ZP2D3	9253	169		
		MacAdam 3step	SPHWAHDNL251ZP3D3				
LC080D Gen 3	70+	3000	MacAdam 1step	SPHWAHDNL271ZW1D3	7177	131	1620mA 50.7V
			MacAdam 2step	SPHWAHDNL271ZW2D3			
		3000	MacAdam 3step	SPHWAHDNL271ZW3D3	7549	138	
			MacAdam 1step	SPHWAHDNL271ZV1D3			
		3500	MacAdam 2step	SPHWAHDNL271ZV2D3	7774	142	
			MacAdam 3step	SPHWAHDNL271ZV3D3			
	MacAdam 1step		SPHWAHDNL271ZU1D3				
	4000	MacAdam 2step	SPHWAHDNL271ZU2D3	7934	145		
		MacAdam 3step	SPHWAHDNL271ZU3D3				
		MacAdam 1step	SPHWAHDNL271ZT1D3				
	90+	5000	MacAdam 2step	SPHWAHDNL271ZT2D3	8002	146	
			MacAdam 3step	SPHWAHDNL271ZT3D3			
5000		MacAdam 2step	SPHWAHDNL271ZR2D3	8002	146		
		MacAdam 3step	SPHWAHDNL271ZR3D3				

Chip-on-Board LEDs

Package

Product	CRI	CCT (K)	Color Rank	Part Number	T _j =85°C		I _F (mA) V _F (V)
					Luminous Flux Typ. (lm)	Luminous Efficacy Typ. (lm/W)	
LC080D Gen 3	70+	3000	MacAdam 2step	SPHWAHDNM231ZV2D3	14115	172	1620mA 50.7V
			MacAdam 3step	SPHWAHDNM231ZV3D3			
		4000	MacAdam 2step	SPHWAHDNM231ZT2D3	14376	175	
			MacAdam 3step	SPHWAHDNM231ZT3D3			
		5000	MacAdam 2step	SPHWAHDNM231ZR2D3	14637	178	
			MacAdam 3step	SPHWAHDNM231ZR3D3			
	2700	MacAdam 1step	SPHWAHDNM251ZW1D3	12437	151		
		MacAdam 2step	SPHWAHDNM251ZW2D3				
		MacAdam 3step	SPHWAHDNM251ZW3D3				
	80+	3000	MacAdam 1step	SPHWAHDNM251ZV1D3	13069	159	
			MacAdam 2step	SPHWAHDNM251ZV2D3			
		3500	MacAdam 3step	SPHWAHDNM251ZV3D3	13452	164	
MacAdam 1step			SPHWAHDNM251ZU1D3				
4000		MacAdam 2step	SPHWAHDNM251ZU2D3	13721	167		
		MacAdam 3step	SPHWAHDNM251ZU3D3				
	MacAdam 1step	SPHWAHDNM251ZT1D3					
90+	5000	MacAdam 2step	SPHWAHDNM251ZT2D3	13836	168		
		MacAdam 3step	SPHWAHDNM251ZT3D3				
	5700	MacAdam 2step	SPHWAHDNM251ZQ2D3	13836	168		
		MacAdam 3step	SPHWAHDNM251ZQ3D3				
	6500	MacAdam 2step	SPHWAHDNM251ZP2D3	13721	167		
		MacAdam 3step	SPHWAHDNM251ZP3D3				
LC080D Gen 3	70+	3000	MacAdam 1step	SPHWAHDNM271ZW1D3	10643	130	1620mA 50.7V
			MacAdam 2step	SPHWAHDNM271ZW2D3			
		3000	MacAdam 3step	SPHWAHDNM271ZW3D3	11195	136	
			MacAdam 1step	SPHWAHDNM271ZV1D3			
		3500	MacAdam 2step	SPHWAHDNM271ZV2D3	11529	140	
			MacAdam 3step	SPHWAHDNM271ZV3D3			
	MacAdam 1step		SPHWAHDNM271ZU1D3				
	4000	MacAdam 2step	SPHWAHDNM271ZU2D3	11766	143		
		MacAdam 3step	SPHWAHDNM271ZU3D3				
		MacAdam 1step	SPHWAHDNM271ZT1D3				
	90+	5000	MacAdam 2step	SPHWAHDNM271ZT2D3	11867	144	
			MacAdam 3step	SPHWAHDNM271ZT3D3			
5000		MacAdam 2step	SPHWAHDNM271ZR2D3	11867	144		
		MacAdam 3step	SPHWAHDNM271ZR3D3				

D Series Gen 3+

Full line-up for various applications: MR/PAR, spotlights, downlights & high bay lights

- Industry-leading light efficacy in COB lineups
- Better thermal resistance than Gen 2+
- High reliability satisfying DLC Premium standards
- Completed 6,000 hours of LM-80 testing

T _J =85°C	LC003D Gen 3+	LC006D Gen 3+	LC009D Gen 3+	LC013D Gen 3+	LC016D Gen 3+	LC019D Gen 3+	LC026D Gen 3+	LC033D Gen 3+	LC040D Gen 3+	LC060D Gen 3+	LC080D Gen 3+	
LES	9.8mm			14.5mm				22 mm				
Typical	33.7V								50.6V			
	3.0W (90 mA)	6.1W (180 mA)	9.1W (270 mA)	12.1W (360 mA)	15.2W (450 mA)	18.2W (540 mA)	24.3W (720 mA)	30.3W (900 mA)	36.4W (1080 mA)	54.6W (1080 mA)	82W (1620 mA)	
Max.	6.6W (180mA)	13.2W (360mA)	19.8W (540mA)	26.4W (720mA)	33W (900mA)	39.5W (1080mA)	52.7W (1440mA)	65.9W (1800mA)	79.1W (2160mA)	118.4W (2160mA)	177.6W (3240mA)	
Dimension												
Size	13.5mm x 13.5mm			19mm x 19mm				28mm x 28mm				

Product	CRI	CCT (K)	Color Rank	Part Number	T _J =85°C		I _F (mA)	V _F (V)
					Luminous Flux Typ. (lm)	Luminous Efficacy Typ. (lm/W)		
LC003D Gen 3+	80+	2700	MacAdam 1step	SPHWAHDNA25YZW1DC	479	158	90mA	33.7V
			MacAdam 2step	SPHWAHDNA25YZW2DC				
			MacAdam 3step	SPHWAHDNA25YZW3DC				
	3000	MacAdam 1step	SPHWAHDNA25YZV1DC	498	164			
		MacAdam 2step	SPHWAHDNA25YZV2DC					
		MacAdam 3step	SPHWAHDNA25YZV3DC					
	3500	MacAdam 1step	SPHWAHDNA25YZU1DC	516	170			
		MacAdam 2step	SPHWAHDNA25YZU2DC					
		MacAdam 3step	SPHWAHDNA25YZU3DC					
	4000	MacAdam 1step	SPHWAHDNA25YZT1DC	526	173			
		MacAdam 2step	SPHWAHDNA25YZT2DC					
		MacAdam 3step	SPHWAHDNA25YZT3DC					
	5000	MacAdam 2step	SPHWAHDNA25YZR2DC	536	177			
		MacAdam 3step	SPHWAHDNA25YZR3DC					
		MacAdam 2step	SPHWAHDNA25YZQ2DC			529		
	MacAdam 3step	SPHWAHDNA25YZQ3DC						
	6500	MacAdam 2step	SPHWAHDNA25YZP2DC	520	171			
		MacAdam 3step	SPHWAHDNA25YZP3DC					
2700		MacAdam 1step	SPHWAHDNA27YZW1DC			407	134	
	MacAdam 2step	SPHWAHDNA27YZW2DC						
	MacAdam 3step	SPHWAHDNA27YZW3DC						
3000	MacAdam 1step	SPHWAHDNA27YZV1DC	428	141				
	MacAdam 2step	SPHWAHDNA27YZV2DC						
	MacAdam 3step	SPHWAHDNA27YZV3DC						
3500	MacAdam 1step	SPHWAHDNA27YZU1DC	441	145				
	MacAdam 2step	SPHWAHDNA27YZU2DC						
	MacAdam 3step	SPHWAHDNA27YZU3DC						
4000	MacAdam 1step	SPHWAHDNA27YZT1DC	450	148				
	MacAdam 2step	SPHWAHDNA27YZT2DC						
	MacAdam 3step	SPHWAHDNA27YZT3DC						
5000	MacAdam 2step	SPHWAHDNA27YZR2DC	459	151				
	MacAdam 3step	SPHWAHDNA27YZR3DC						

Chip-on-Board LEDs

Package

Product	CRI	CCT (K)	Color Rank	Part Number	T _j =85°C		I _F (mA) V _F (V)
					Luminous Flux Typ. (lm)	Luminous Efficacy Typ. (lm/W)	
LC006D Gen 3+	80+	2700	MacAdam 1step	SPHWAHDNB25YZW1DC	945	156	180mA 33.7V
			MacAdam 2step	SPHWAHDNB25YZW2DC			
			MacAdam 3step	SPHWAHDNB25YZW3DC			
	3000	MacAdam 1step	SPHWAHDNB25YZV1DC	983	162		
		MacAdam 2step	SPHWAHDNB25YZV2DC				
		MacAdam 3step	SPHWAHDNB25YZV3DC				
	3500	MacAdam 1step	SPHWAHDNB25YZU1DC	1021	168		
		MacAdam 2step	SPHWAHDNB25YZU2DC				
		MacAdam 3step	SPHWAHDNB25YZU3DC				
	4000	MacAdam 1step	SPHWAHDNB25YZT1DC	1038	171		
		MacAdam 2step	SPHWAHDNB25YZT2DC				
		MacAdam 3step	SPHWAHDNB25YZT3DC				
	5000	MacAdam 2step	SPHWAHDNB25YZR2DC	1056	174		
		MacAdam 3step	SPHWAHDNB25YZR3DC				
		MacAdam 2step	SPHWAHDNB25YZQ2DC			1038	
	MacAdam 3step	SPHWAHDNB25YZQ3DC					
	6500	MacAdam 2step	SPHWAHDNB25YZP2DC	1022	168		
		MacAdam 3step	SPHWAHDNB25YZP3DC				
		2700	MacAdam 1step			SPHWAHDNB27YZW1DC	
	MacAdam 2step		SPHWAHDNB27YZW2DC				
	MacAdam 3step		SPHWAHDNB27YZW3DC				
	3000	MacAdam 1step	SPHWAHDNB27YZV1DC	838	138		
		MacAdam 2step	SPHWAHDNB27YZV2DC				
		MacAdam 3step	SPHWAHDNB27YZV3DC				
3500	MacAdam 1step	SPHWAHDNB27YZU1DC	865	143			
	MacAdam 2step	SPHWAHDNB27YZU2DC					
	MacAdam 3step	SPHWAHDNB27YZU3DC					
4000	MacAdam 1step	SPHWAHDNB27YZT1DC	884	146			
	MacAdam 2step	SPHWAHDNB27YZT2DC					
	MacAdam 3step	SPHWAHDNB27YZT3DC					
5000	MacAdam 2step	SPHWAHDNB27YZR2DC	902	149			
	MacAdam 3step	SPHWAHDNB27YZR3DC					



LC006D Gen 3+

Chip-on-Board LEDs

Package

Product	CRI	CCT (K)	Color Rank	Part Number	T _j =85°C		I _F (mA) V _F (V)
					Luminous Flux Typ. (lm)	Luminous Efficacy Typ. (lm/W)	
LC009D Gen 3+	70+	3000	MacAdam 2step	SPHWAHDNC23YZV2DC	1586	174	270mA 33.7V
			MacAdam 3step	SPHWAHDNC23YZV3DC			
		4000	MacAdam 2step	SPHWAHDNC23YZT2DC	1610	177	
			MacAdam 3step	SPHWAHDNC23YZT3DC			
		5000	MacAdam 2step	SPHWAHDNC23YZR2DC	1625	179	
			MacAdam 3step	SPHWAHDNC23YZR3DC			
	80+	2700	MacAdam 1step	SPHWAHDNC25YZW1DC	1406	155	
			MacAdam 2step	SPHWAHDNC25YZW2DC			
		3000	MacAdam 1step	SPHWAHDNC25YZV1DC	1463	161	
			MacAdam 2step	SPHWAHDNC25YZV2DC			
		3500	MacAdam 1step	SPHWAHDNC25YZU1DC	1519	167	
			MacAdam 2step	SPHWAHDNC25YZU2DC			
	90+	4000	MacAdam 1step	SPHWAHDNC25YZT1DC	1550	170	
			MacAdam 2step	SPHWAHDNC25YZT2DC			
		5000	MacAdam 1step	SPHWAHDNC25YZR2DC	1576	173	
			MacAdam 3step	SPHWAHDNC25YZR3DC			
		5700	MacAdam 2step	SPHWAHDNC25YZQ2DC	1555	171	
			MacAdam 3step	SPHWAHDNC25YZQ3DC			
	90+	6500	MacAdam 2step	SPHWAHDNC25YZP2DC	1529	168	
			MacAdam 3step	SPHWAHDNC25YZP3DC			
		2700	MacAdam 1step	SPHWAHDNC27YZW1DC	1190	131	
			MacAdam 2step	SPHWAHDNC27YZW2DC			
		3000	MacAdam 1step	SPHWAHDNC27YZV1DC	1254	138	
			MacAdam 2step	SPHWAHDNC27YZV2DC			
3500	MacAdam 1step	SPHWAHDNC27YZU1DC	1294	142			
	MacAdam 2step	SPHWAHDNC27YZU2DC					
90+	4000	MacAdam 1step	SPHWAHDNC27YZT1DC	1322	145		
		MacAdam 2step	SPHWAHDNC27YZT2DC				
	5000	MacAdam 1step	SPHWAHDNC27YZU1DC	1348	148		
		MacAdam 2step	SPHWAHDNC27YZR2DC				
	5000	MacAdam 2step	SPHWAHDNC27YZR2DC	1348	148		
		MacAdam 3step	SPHWAHDNC27YZR3DC				



LC009D Gen 3+

Chip-on-Board LEDs

Package

Product	CRI	CCT (K)	Color Rank	Part Number	T _j =85°C		I _F (mA) V _F (V)
					Luminous Flux Typ. (lm)	Luminous Efficacy Typ. (lm/W)	
LC013D Gen 3+	70+	3000	MacAdam 2step	SPHWHAHDND23YZV2DC	2098	173	360mA 33.7V
			MacAdam 3step	SPHWHAHDND23YZV3DC			
		4000	MacAdam 2step	SPHWHAHDND23YZT2DC	2133	176	
			MacAdam 3step	SPHWHAHDND23YZT3DC			
		5000	MacAdam 2step	SPHWHAHDND23YZR2DC	2162	178	
			MacAdam 3step	SPHWHAHDND23YZR3DC			
	2700	MacAdam 1step	SPHWHAHDND25YZW1DC	1869	154		
		MacAdam 2step	SPHWHAHDND25YZW2DC				
		MacAdam 3step	SPHWHAHDND25YZW3DC				
	3000	MacAdam 1step	SPHWHAHDND25YZV1DC	1945	160		
		MacAdam 2step	SPHWHAHDND25YZV2DC				
		MacAdam 3step	SPHWHAHDND25YZV3DC				
	3500	MacAdam 1step	SPHWHAHDND25YZU1DC	2020	167		
		MacAdam 2step	SPHWHAHDND25YZU2DC				
		MacAdam 3step	SPHWHAHDND25YZU3DC				
	80+	4000	MacAdam 1step	SPHWHAHDND25YZT1DC	2056	169	
			MacAdam 2step	SPHWHAHDND25YZT2DC			
			MacAdam 3step	SPHWHAHDND25YZT3DC			
5000		MacAdam 2step	SPHWHAHDND25YZR2DC	2090	172		
		MacAdam 3step	SPHWHAHDND25YZR3DC				
		MacAdam 2step	SPHWHAHDND25YZQ2DC			2057	170
MacAdam 3step	SPHWHAHDND25YZQ3DC						
6500	MacAdam 2step	SPHWHAHDND25YZP2DC	2034	168			
	MacAdam 3step	SPHWHAHDND25YZP3DC					
	MacAdam 1step	SPHWHAHDND27YZW1DC			1579	130	
2700	MacAdam 2step	SPHWHAHDND27YZW2DC					
	MacAdam 3step	SPHWHAHDND27YZW3DC					
	3000	MacAdam 1step	SPHWHAHDND27YZV1DC	1661	137		
MacAdam 2step		SPHWHAHDND27YZV2DC					
MacAdam 3step		SPHWHAHDND27YZV3DC					
90+	3500	MacAdam 1step	SPHWHAHDND27YZU1DC	1712	141		
		MacAdam 2step	SPHWHAHDND27YZU2DC				
		MacAdam 3step	SPHWHAHDND27YZU3DC				
	4000	MacAdam 1step	SPHWHAHDND27YZT1DC	1748	144		
		MacAdam 2step	SPHWHAHDND27YZT2DC				
		MacAdam 3step	SPHWHAHDND27YZT3DC				
5000	MacAdam 2step	SPHWHAHDND37YZR2DC	1792	148			
	MacAdam 3step	SPHWHAHDND37YZR3DC					



LC013D Gen 3+

Chip-on-Board LEDs

Package

Product	CRI	CCT (K)	Color Rank	Part Number	T _j =85°C		I _F (mA) V _F (V)
					Luminous Flux Typ. (lm)	Luminous Efficacy Typ. (lm/W)	
LC016D Gen 3+	70+	3000	MacAdam 2step	SPHWHAHDNE23YZV2DC	2727	180	450mA 33.7V
			MacAdam 3step	SPHWHAHDNE23YZV3DC			
		4000	MacAdam 2step	SPHWHAHDNE23YZT2DC	2763	182	
			MacAdam 3step	SPHWHAHDNE23YZT3DC			
		5000	MacAdam 2step	SPHWHAHDNE23YZR2DC	2797	184	
			MacAdam 3step	SPHWHAHDNE23YZR3DC			
	2700	MacAdam 1step	SPHWHAHDNE25YZW1DC	2426	160		
		MacAdam 2step	SPHWHAHDNE25YZW2DC				
		MacAdam 3step	SPHWHAHDNE25YZW3DC				
	3000	MacAdam 1step	SPHWHAHDNE25YZV1DC	2524	166		
		MacAdam 2step	SPHWHAHDNE25YZV2DC				
		MacAdam 3step	SPHWHAHDNE25YZV3DC				
	3500	MacAdam 1step	SPHWHAHDNE25YZU1DC	2621	173		
		MacAdam 2step	SPHWHAHDNE25YZU2DC				
		MacAdam 3step	SPHWHAHDNE25YZU3DC				
	80+	4000	MacAdam 1step	SPHWHAHDNE25YZT1DC	2669	176	
			MacAdam 2step	SPHWHAHDNE25YZT2DC			
			MacAdam 3step	SPHWHAHDNE25YZT3DC			
5000		MacAdam 2step	SPHWHAHDNE25YZR2DC	2713	179		
		MacAdam 3step	SPHWHAHDNE25YZR3DC				
		MacAdam 2step	SPHWHAHDNE25YZQ2DC			2670	176
MacAdam 3step	SPHWHAHDNE25YZQ3DC						
6500	MacAdam 2step	SPHWHAHDNE25YZP2DC	2627	173			
	MacAdam 3step	SPHWHAHDNE25YZP3DC					
	MacAdam 1step	SPHWHAHDNE27YZW1DC			2047	135	
2700	MacAdam 2step	SPHWHAHDNE27YZW2DC					
	MacAdam 3step	SPHWHAHDNE27YZW3DC					
	3000	MacAdam 1step	SPHWHAHDNE27YZV1DC	2154	142		
MacAdam 2step		SPHWHAHDNE27YZV2DC					
MacAdam 3step		SPHWHAHDNE27YZV3DC					
90+	3500	MacAdam 1step	SPHWHAHDNE27YZU1DC	2223	147		
		MacAdam 2step	SPHWHAHDNE27YZU2DC				
		MacAdam 3step	SPHWHAHDNE27YZU3DC				
	4000	MacAdam 1step	SPHWHAHDNE27YZT1DC	2273	150		
		MacAdam 2step	SPHWHAHDNE27YZT2DC				
		MacAdam 3step	SPHWHAHDNE27YZT3DC				
5000	MacAdam 1step	SPHWHAHDNE27YZR1DC	2328	154			
	MacAdam 3step	SPHWHAHDNE27YZR3DC					



LC016D Gen 3+

Chip-on-Board LEDs

Package

Product	CRI	CCT (K)	Color Rank	Part Number	T _j =85°C		I _F (mA) V _F (V)
					Luminous Flux Typ. (lm)	Luminous Efficacy Typ. (lm/W)	
LC019D Gen 3+	70+	3000	MacAdam 2step	SPHWAHDNF23YZV2DC	3284	180	540mA 33.7V
			MacAdam 3step	SPHWAHDNF23YZV3DC			
		4000	MacAdam 2step	SPHWAHDNF23YZT2DC	3332	183	
			MacAdam 3step	SPHWAHDNF23YZT3DC			
		5000	MacAdam 2step	SPHWAHDNF23YZR2DC	3369	185	
			MacAdam 3step	SPHWAHDNF23YZR3DC			
	2700	MacAdam 1step	SPHWAHDNF25YZW1DC	2925	161		
		MacAdam 2step	SPHWAHDNF25YZW2DC				
		MacAdam 3step	SPHWAHDNF25YZW3DC				
	3000	MacAdam 1step	SPHWAHDNF25YZV1DC	3044	167		
		MacAdam 2step	SPHWAHDNF25YZV2DC				
		MacAdam 3step	SPHWAHDNF25YZV3DC				
	3500	MacAdam 1step	SPHWAHDNF25YZU1DC	3161	174		
		MacAdam 2step	SPHWAHDNF25YZU2DC				
		MacAdam 3step	SPHWAHDNF25YZU3DC				
	80+	4000	MacAdam 1step	SPHWAHDNF25YZT1DC	3218	177	
			MacAdam 2step	SPHWAHDNF25YZT2DC			
			MacAdam 3step	SPHWAHDNF25YZT3DC			
5000	MacAdam 2step	SPHWAHDNF25YZR2DC	3271	180			
	MacAdam 3step	SPHWAHDNF25YZR3DC					
	MacAdam 2step	SPHWAHDNF25YZQ2DC			3217	177	
MacAdam 3step	SPHWAHDNF25YZQ3DC						
6500	MacAdam 2step	SPHWAHDNF25YZP2DC	3164	174			
	MacAdam 3step	SPHWAHDNF25YZP3DC					
	MacAdam 1step	SPHWAHDNF27YZW1DC			2469	136	
2700	MacAdam 2step	SPHWAHDNF27YZW2DC					
	MacAdam 3step	SPHWAHDNF27YZW3DC					
	3000	MacAdam 1step	SPHWAHDNF27YZV1DC	2597	143		
MacAdam 2step		SPHWAHDNF27YZV2DC					
MacAdam 3step		SPHWAHDNF27YZV3DC					
90+	3500	MacAdam 1step	SPHWAHDNF27YZU1DC	2680	147		
		MacAdam 2step	SPHWAHDNF27YZU2DC				
		MacAdam 3step	SPHWAHDNF27YZU3DC				
4000	MacAdam 1step	SPHWAHDNF27YZT1DC	2738	150			
	MacAdam 2step	SPHWAHDNF27YZT2DC					
	MacAdam 3step	SPHWAHDNF27YZT3DC					
5000	MacAdam 2step	SPHWAHDNF27YZR2DC	2804	154			
	MacAdam 3step	SPHWAHDNF27YZR3DC					



LC019D Gen 3+

Chip-on-Board LEDs

Package

Product	CRI	CCT (K)	Color Rank	Part Number	T _j =85°C		I _F (mA) V _F (V)
					Luminous Flux Typ. (lm)	Luminous Efficacy Typ. (lm/W)	
LC026D Gen 3+	70+	3000	MacAdam 2step	SPHWAHDNG23YZV2DC	4289	177	720mA 33.7V
			MacAdam 3step	SPHWAHDNG23YZV3DC			
		4000	MacAdam 2step	SPHWAHDNG23YZT2DC	4347	179	
			MacAdam 3step	SPHWAHDNG23YZT3DC			
		5000	MacAdam 2step	SPHWAHDNG23YZR2DC	4396	181	
			MacAdam 3step	SPHWAHDNG23YZR3DC			
	2700	MacAdam 1step	SPHWAHDNG25YZW1DC	3816	157		
		MacAdam 2step	SPHWAHDNG25YZW2DC				
		MacAdam 3step	SPHWAHDNG25YZW3DC				
	3000	MacAdam 1step	SPHWAHDNG25YZV1DC	3971	164		
		MacAdam 2step	SPHWAHDNG25YZV2DC				
		MacAdam 3step	SPHWAHDNG25YZV3DC				
	3500	MacAdam 1step	SPHWAHDNG25YZU1DC	4125	170		
		MacAdam 2step	SPHWAHDNG25YZU2DC				
		MacAdam 3step	SPHWAHDNG25YZU3DC				
	80+	4000	MacAdam 1step	SPHWAHDNG25YZT1DC	4198	173	
			MacAdam 2step	SPHWAHDNG25YZT2DC			
			MacAdam 3step	SPHWAHDNG25YZT3DC			
5000	MacAdam 2step	SPHWAHDNG25YZR2DC	4268	176			
	MacAdam 3step	SPHWAHDNG25YZR3DC					
	MacAdam 2step	SPHWAHDNG25YZQ2DC			4301	177	
MacAdam 3step	SPHWAHDNG25YZQ3DC						
6500	MacAdam 2step	SPHWAHDNG25YZP2DC	4133	170			
	MacAdam 3step	SPHWAHDNG25YZP3DC					
	MacAdam 1step	SPHWAHDNG27YZW1DC			3222	133	
2700	MacAdam 2step	SPHWAHDNG27YZW2DC					
	MacAdam 3step	SPHWAHDNG27YZW3DC					
	3000	MacAdam 1step	SPHWAHDNG27YZV1DC	3389	140		
MacAdam 2step		SPHWAHDNG27YZV2DC					
MacAdam 3step		SPHWAHDNG27YZV3DC					
90+	3500	MacAdam 1step	SPHWAHDNG27YZU1DC	3496	144		
		MacAdam 2step	SPHWAHDNG27YZU2DC				
		MacAdam 3step	SPHWAHDNG27YZU3DC				
4000	MacAdam 1step	SPHWAHDNG27YZT1DC	3572	147			
	MacAdam 2step	SPHWAHDNG27YZT2DC					
	MacAdam 3step	SPHWAHDNG27YZT3DC					
5000	MacAdam 2step	SPHWAHDNG27YZR2DC	3663	151			
	MacAdam 3step	SPHWAHDNG27YZR3DC					



LC026D Gen 3+

Chip-on-Board LEDs

Package

Product	CRI	CCT (K)	Color Rank	Part Number	T _j =85°C		I _F (mA) V _F (V)
					Luminous Flux Typ. (lm)	Luminous Efficacy Typ. (lm/W)	
LC033D Gen 3+	70+	3000	MacAdam 2step	SPHWAHDNH23YZV2DC	5261	173	900mA 33.7V
			MacAdam 3step	SPHWAHDNH23YZV3DC			
		4000	MacAdam 2step	SPHWAHDNH23YZT2DC	5337	176	
			MacAdam 3step	SPHWAHDNH23YZT3DC			
		5000	MacAdam 2step	SPHWAHDNH23YZR2DC	5424	179	
			MacAdam 3step	SPHWAHDNH23YZR3DC			
	2700	MacAdam 1step	SPHWAHDNH25YZW1DC	4686	155		
		MacAdam 2step	SPHWAHDNH25YZW2DC				
		MacAdam 3step	SPHWAHDNH25YZW3DC				
	3000	MacAdam 1step	SPHWAHDNH25YZV1DC	4875	161		
		MacAdam 2step	SPHWAHDNH25YZV2DC				
		MacAdam 3step	SPHWAHDNH25YZV3DC				
80+	3500	MacAdam 1step	SPHWAHDNH25YZU1DC	5064	167		
		MacAdam 2step	SPHWAHDNH25YZU2DC				
		MacAdam 3step	SPHWAHDNH25YZU3DC				
	4000	MacAdam 1step	SPHWAHDNH25YZT1DC	5150	170		
		MacAdam 2step	SPHWAHDNH25YZT2DC				
		MacAdam 3step	SPHWAHDNH25YZT3DC				
5000	MacAdam 2step	SPHWAHDNH25YZR2DC	5240	173			
	MacAdam 3step	SPHWAHDNH25YZR3DC					
	MacAdam 2step	SPHWAHDNH25YZQ2DC			5158	170	
MacAdam 3step	SPHWAHDNH25YZQ3DC						
6500	MacAdam 2step	SPHWAHDNH25YZP2DC	5089	168			
	MacAdam 3step	SPHWAHDNH25YZP3DC					
	MacAdam 1step	SPHWAHDNH27YZW1DC			3955	130	
2700	MacAdam 2step	SPHWAHDNH27YZW2DC					
	MacAdam 3step	SPHWAHDNH27YZW3DC					
90+	3000	MacAdam 1step	SPHWAHDNH27YZV1DC	4160	137		
		MacAdam 2step	SPHWAHDNH27YZV2DC				
		MacAdam 3step	SPHWAHDNH27YZV3DC				
	3500	MacAdam 1step	SPHWAHDNH27YZU1DC	4293	142		
		MacAdam 2step	SPHWAHDNH27YZU2DC				
		MacAdam 3step	SPHWAHDNH27YZU3DC				
4000	MacAdam 1step	SPHWAHDNH27YZT1DC	4386	145			
	MacAdam 2step	SPHWAHDNH27YZT2DC					
	MacAdam 3step	SPHWAHDNH27YZT3DC					
5000	MacAdam 2step	SPHWAHDNH27YZR2DC	4493	148			
	MacAdam 3step	SPHWAHDNH27YZR3DC					



LC033D Gen 3+

Chip-on-Board LEDs

Package

Product	CRI	CCT (K)	Color Rank	Part Number	T _j =85°C		I _F (mA) V _F (V)
					Luminous Flux Typ. (lm)	Luminous Efficacy Typ. (lm/W)	
LC040D Gen 3+	70+	3000	MacAdam 2step	SPHWAHDNK23YZV2DC	6446	177	1080mA 33.7V
			MacAdam 3step	SPHWAHDNK23YZV3DC			
		4000	MacAdam 2step	SPHWAHDNK23YZT2DC	6560	180	
			MacAdam 3step	SPHWAHDNK23YZT3DC			
		5000	MacAdam 2step	SPHWAHDNK23YZR2DC	6639	182	
			MacAdam 3step	SPHWAHDNK23YZR3DC			
	2700	MacAdam 1step	SPHWAHDNK25YZW1DC	5737	158		
		MacAdam 2step	SPHWAHDNK25YZW2DC				
		MacAdam 3step	SPHWAHDNK25YZW3DC				
	3000	MacAdam 1step	SPHWAHDNK25YZV1DC	5968	164		
		MacAdam 2step	SPHWAHDNK25YZV2DC				
		MacAdam 3step	SPHWAHDNK25YZV3DC				
80+	3500	MacAdam 1step	SPHWAHDNK25YZU1DC	6199	170		
		MacAdam 2step	SPHWAHDNK25YZU2DC				
		MacAdam 3step	SPHWAHDNK25YZU3DC				
	4000	MacAdam 1step	SPHWAHDNK25YZT1DC	6311	173		
		MacAdam 2step	SPHWAHDNK25YZT2DC				
		MacAdam 3step	SPHWAHDNK25YZT3DC				
5000	MacAdam 2step	SPHWAHDNK25YZR2DC	6414	176			
	MacAdam 3step	SPHWAHDNK25YZR3DC					
	MacAdam 2step	SPHWAHDNK25YZQ2DC			6313	173	
MacAdam 3step	SPHWAHDNK25YZQ3DC						
6500	MacAdam 2step	SPHWAHDNK25YZP2DC	6242	172			
	MacAdam 3step	SPHWAHDNK25YZP3DC					
	MacAdam 1step	SPHWAHDNK27YZW1DC			4856	133	
2700	MacAdam 2step	SPHWAHDNK27YZW2DC					
	MacAdam 3step	SPHWAHDNK27YZW3DC					
90+	3000	MacAdam 1step	SPHWAHDNK27YZV1DC	5108	140		
		MacAdam 2step	SPHWAHDNK27YZV2DC				
		MacAdam 3step	SPHWAHDNK27YZV3DC				
	3500	MacAdam 1step	SPHWAHDNK27YZU1DC	5260	145		
		MacAdam 2step	SPHWAHDNK27YZU2DC				
		MacAdam 3step	SPHWAHDNK27YZU3DC				
4000	MacAdam 1step	SPHWAHDNK27YZT1DC	5374	148			
	MacAdam 2step	SPHWAHDNK27YZT2DC					
	MacAdam 3step	SPHWAHDNK27YZT3DC					
5000	MacAdam 2step	SPHWAHDNK27YZR2DC	5507	151			
	MacAdam 3step	SPHWAHDNK27YZR3DC					



LC040D Gen 3+

Chip-on-Board LEDs

Package

Product	CRI	CCT (K)	Color Rank	Part Number	T _j =85°C		I _F (mA) V _F (V)
					Luminous Flux Typ. (lm)	Luminous Efficacy Typ. (lm/W)	
LC060D Gen 3+	70+	3000	MacAdam 2step	SPHWAHDNL231ZV2DC	9585	175	1080mA 50.6V
			MacAdam 3step	SPHWAHDNL231ZV3DC			
		4000	MacAdam 2step	SPHWAHDNL231ZT2DC	9723	178	
			MacAdam 3step	SPHWAHDNL231ZT3DC			
		5000	MacAdam 2step	SPHWAHDNL231ZR2DC	9870	181	
			MacAdam 3step	SPHWAHDNL231ZR3DC			
	2700	MacAdam 1step	SPHWAHDNL251ZW1DC	8537	156		
		MacAdam 2step	SPHWAHDNL251ZW2DC				
		MacAdam 3step	SPHWAHDNL251ZW3DC				
	3000	MacAdam 1step	SPHWAHDNL251ZV1DC	8882	163		
		MacAdam 2step	SPHWAHDNL251ZV2DC				
		MacAdam 3step	SPHWAHDNL251ZV3DC				
80+	3500	MacAdam 1step	SPHWAHDNL251ZU1DC	9225	169		
		MacAdam 2step	SPHWAHDNL251ZU2DC				
		MacAdam 3step	SPHWAHDNL251ZU3DC				
	4000	MacAdam 1step	SPHWAHDNL251ZT1DC	9383	172		
		MacAdam 2step	SPHWAHDNL251ZT2DC				
		MacAdam 3step	SPHWAHDNL251ZT3DC				
5000	MacAdam 2step	SPHWAHDNL251ZR2DC	9546	175			
	MacAdam 3step	SPHWAHDNL251ZR3DC					
	MacAdam 2step	SPHWAHDNL251ZQ2DC			9395	172	
MacAdam 3step	SPHWAHDNL251ZQ3DC						
6500	MacAdam 2step	SPHWAHDNL251ZP2DC	9253	169			
	MacAdam 3step	SPHWAHDNL251ZP3DC					
	MacAdam 1step	SPHWAHDNL271ZW1DC			7206	132	
2700	MacAdam 2step	SPHWAHDNL271ZW2DC					
	MacAdam 3step	SPHWAHDNL271ZW3DC					
	3000	MacAdam 1step	SPHWAHDNL271ZV1DC	7579	139		
MacAdam 2step		SPHWAHDNL271ZV2DC					
MacAdam 3step		SPHWAHDNL271ZV3DC					
90+	3500	MacAdam 1step	SPHWAHDNL271ZU1DC	7821	143		
		MacAdam 2step	SPHWAHDNL271ZU2DC				
		MacAdam 3step	SPHWAHDNL271ZU3DC				
	4000	MacAdam 1step	SPHWAHDNL271ZT1DC	7990	146		
		MacAdam 2step	SPHWAHDNL271ZT2DC				
		MacAdam 3step	SPHWAHDNL271ZT3DC				
5000	MacAdam 2step	SPHWAHDNL271ZR2DC	8186	150			
	MacAdam 3step	SPHWAHDNL271ZR3DC					



Chip-on-Board LEDs

Package

Product	CRI	CCT (K)	Color Rank	Part Number	T _j =85°C		I _F (mA) V _F (V)
					Luminous Flux Typ. (lm)	Luminous Efficacy Typ. (lm/W)	
LC080D Gen 3+	70+	3000	MacAdam 2step	SPHWAHDNM231ZV2DC	14087	172	1620mA 50.6V
			MacAdam 3step	SPHWAHDNM231ZV3DC			
		4000	MacAdam 2step	SPHWAHDNM231ZT2DC	14290	174	
			MacAdam 3step	SPHWAHDNM231ZT3DC			
		5000	MacAdam 2step	SPHWAHDNM231ZR2DC	14449	176	
			MacAdam 3step	SPHWAHDNM231ZR3DC			
	2700	MacAdam 1step	SPHWAHDNM251ZW1DC	12487	152		
		MacAdam 2step	SPHWAHDNM251ZW2DC				
		MacAdam 3step	SPHWAHDNM251ZW3DC				
	3000	MacAdam 1step	SPHWAHDNM251ZV1DC	12990	158		
		MacAdam 2step	SPHWAHDNM251ZV2DC				
		MacAdam 3step	SPHWAHDNM251ZV3DC				
80+	3500	MacAdam 1step	SPHWAHDNM251ZU1DC	13492	165		
		MacAdam 2step	SPHWAHDNM251ZU2DC				
		MacAdam 3step	SPHWAHDNM251ZU3DC				
	4000	MacAdam 1step	SPHWAHDNM251ZT1DC	13735	168		
		MacAdam 2step	SPHWAHDNM251ZT2DC				
		MacAdam 3step	SPHWAHDNM251ZT3DC				
5000	MacAdam 2step	SPHWAHDNM251ZR2DC	13961	170			
	MacAdam 3step	SPHWAHDNM251ZR3DC					
	MacAdam 2step	SPHWAHDNM251ZQ2DC			13767	168	
MacAdam 3step	SPHWAHDNM251ZQ3DC						
6500	MacAdam 2step	SPHWAHDNM251ZP2DC	13585	166			
	MacAdam 3step	SPHWAHDNM251ZP3DC					
	MacAdam 1step	SPHWAHDNM271ZW1DC			10590	129	
2700	MacAdam 2step	SPHWAHDNM271ZW2DC					
	MacAdam 3step	SPHWAHDNM271ZW3DC					
	3000	MacAdam 1step	SPHWAHDNM271ZV1DC	11139	136		
MacAdam 2step		SPHWAHDNM271ZV2DC					
MacAdam 3step		SPHWAHDNM271ZV3DC					
90+	3500	MacAdam 1step	SPHWAHDNM271ZU1DC	11495	140		
		MacAdam 2step	SPHWAHDNM271ZU2DC				
		MacAdam 3step	SPHWAHDNM271ZU3DC				
	4000	MacAdam 1step	SPHWAHDNM271ZT1DC	11743	143		
		MacAdam 2step	SPHWAHDNM271ZT2DC				
		MacAdam 3step	SPHWAHDNM271ZT3DC				
5000	MacAdam 2step	SPHWAHDNM271ZR2DC	11974	146			
	MacAdam 3step	SPHWAHDNM271ZR3DC					



D Series Gen 2

Full line-up for various applications: MR/PAR, spotlights, downlights & high bay lights

- Industry-leading light efficacy in COB lineups
- Better thermal resistance than Gen 1
- High reliability satisfying DLC Premium standards
- Completed 6,000 hours of LM-80 testing

T _J =85°C	9.8mm			14.5mm				22 mm			
	LC003D Gen 2	LC006D Gen 2	LC009D Gen 2	LC013D Gen 2	LC016D Gen 2	LC019D Gen 2	LC026D Gen 2	LC033D Gen 2	LC040D Gen 2	LC060D Gen 2	LC080D Gen 2
LES	9.8mm			14.5mm				22 mm			
Typical	3.1 W (90 mA)	6.2 W (180 mA)	9.4 W (270 mA)	12.5 W (360 mA)	15.6 W (450 mA)	18.7 W (540 mA)	24.9 W (720 mA)	31.1W (900 mA)	37.4 W (1080 mA)	56.1 W (1080 mA)	84.2 W (1620 mA)
Max.	8.6 W (230 mA)	17.2W (460 mA)	25.9 W (690 mA)	34.5 W (920 mA)	43.1 W (1150 mA)	51.8 W (1380 mA)	69 W (1840 mA)	86.2 W (2300 mA)	103.5 W (2760 mA)	143.4 W (2760 mA)	215 W (4140 mA)
Dimension											
Size	13.5mm x 13.5mm			19mm x 19mm				28mm x 28mm			

Product	CRI	CCT (K)	Color Rank	Part Number	T _J =85°C		I _F (mA)	V _F (V)
					Luminous Flux Typ. (lm)	Luminous Efficacy Typ. (lm/W)		
LC003D Gen 2	80+	2700	MacAdam 1step	SPHWAHDNA25YZW1D2	459	147	90mA	34.6V
			MacAdam 2step	SPHWAHDNA25YZW2D2				
			MacAdam 3step	SPHWAHDNA25YZW3D2				
	3000	MacAdam 1step	SPHWAHDNA25YZV1D2	483	155			
		MacAdam 2step	SPHWAHDNA25YZV2D2					
		MacAdam 3step	SPHWAHDNA25YZV3D2					
	3500	MacAdam 1step	SPHWAHDNA25YZU1D2	501	161			
		MacAdam 2step	SPHWAHDNA25YZU2D2					
		MacAdam 3step	SPHWAHDNA25YZU3D2					
	4000	MacAdam 1step	SPHWAHDNA25YZT1D2	507	163			
		MacAdam 2step	SPHWAHDNA25YZT2D2					
		MacAdam 3step	SPHWAHDNA25YZT3D2					
	5000	MacAdam 2step	SPHWAHDNA25YZR2D2	513	165			
		MacAdam 3step	SPHWAHDNA25YZR3D2					
		MacAdam 2step	SPHWAHDNA25YZQ2D2			513		
	MacAdam 3step	SPHWAHDNA25YZQ3D2						
	6500	MacAdam 2step	SPHWAHDNA25YZP2D2	507	163			
		MacAdam 3step	SPHWAHDNA25YZP3D2					
2700		MacAdam 1step	SPHWAHDNA27YZW1D2			388	125	
	MacAdam 2step	SPHWAHDNA27YZW2D2						
	MacAdam 3step	SPHWAHDNA27YZW3D2						
3000	MacAdam 1step	SPHWAHDNA27YZV1D2	406	130				
	MacAdam 2step	SPHWAHDNA27YZV2D2						
	MacAdam 3step	SPHWAHDNA27YZV3D2						
3500	MacAdam 1step	SPHWAHDNA27YZU1D2	419	135				
	MacAdam 2step	SPHWAHDNA27YZU2D2						
	MacAdam 3step	SPHWAHDNA27YZU3D2						
4000	MacAdam 1step	SPHWAHDNA27YZT1D2	427	137				
	MacAdam 2step	SPHWAHDNA27YZT2D2						
	MacAdam 3step	SPHWAHDNA27YZT3D2						
5000	MacAdam 2step	SPHWAHDNA27YZR2D2	430	138				
	MacAdam 3step	SPHWAHDNA27YZR3D2						

Chip-on-Board LEDs

Package

Product	CRI	CCT (K)	Color Rank	Part Number	T _j =85°C		I _F (mA) V _F (V)
					Luminous Flux Typ. (lm)	Luminous Efficacy Typ. (lm/W)	
 LC006D Gen 2	80+	2700	MacAdam 1step	SPHWAHDNB25YZW1D2	924	148	180mA 34.6V
			MacAdam 2step	SPHWAHDNB25YZW2D2			
			MacAdam 3step	SPHWAHDNB25YZW3D2			
	3000	MacAdam 1step	SPHWAHDNB25YZV1D2	971	156		
		MacAdam 2step	SPHWAHDNB25YZV2D2				
		MacAdam 3step	SPHWAHDNB25YZV3D2				
	3500	MacAdam 1step	SPHWAHDNB25YZU1D2	1001	161		
		MacAdam 2step	SPHWAHDNB25YZU2D2				
		MacAdam 3step	SPHWAHDNB25YZU3D2				
	4000	MacAdam 1step	SPHWAHDNB25YZT1D2	1024	164		
		MacAdam 2step	SPHWAHDNB25YZT2D2				
		MacAdam 3step	SPHWAHDNB25YZT3D2				
	5000	MacAdam 2step	SPHWAHDNB25YZR2D2	1030	165		
		MacAdam 3step	SPHWAHDNB25YZR3D2				
		MacAdam 2step	SPHWAHDNB25YZQ2D2			1030	
	MacAdam 3step	SPHWAHDNB25YZQ3D2					
	6500	MacAdam 2step	SPHWAHDNB25YZP2D2	1018	163		
		MacAdam 3step	SPHWAHDNB25YZP3D2				
		2700	MacAdam 1step			SPHWAHDNB27YZW1D2	
	MacAdam 2step		SPHWAHDNB27YZW2D2				
	MacAdam 3step		SPHWAHDNB27YZW3D2				
	3000	MacAdam 1step	SPHWAHDNB27YZV1D2	824	132		
		MacAdam 2step	SPHWAHDNB27YZV2D2				
		MacAdam 3step	SPHWAHDNB27YZV3D2				
3500	MacAdam 1step	SPHWAHDNB27YZU1D2	853	137			
	MacAdam 2step	SPHWAHDNB27YZU2D2					
	MacAdam 3step	SPHWAHDNB27YZU3D2					
4000	MacAdam 1step	SPHWAHDNB27YZT1D2	870	140			
	MacAdam 2step	SPHWAHDNB27YZT2D2					
	MacAdam 3step	SPHWAHDNB27YZT3D2					
5000	MacAdam 2step	SPHWAHDNB27YZR2D2	874	140			
	MacAdam 3step	SPHWAHDNB27YZR3D2					

Chip-on-Board LEDs

Package

Product	CRI	CCT (K)	Color Rank	Part Number	T _j =85°C		I _F (mA) V _F (V)
					Luminous Flux Typ. (lm)	Luminous Efficacy Typ. (lm/W)	
 LC009D Gen 2	70+	3000	MacAdam 2step	SPHWAHDNC23YZV2D2	1578	161	270mA 34.6V
			MacAdam 3step	SPHWAHDNC23YZV3D2			
			MacAdam 2step	SPHWAHDNC23YZT2D2			
		MacAdam 3step	SPHWAHDNC23YZT3D2				
		MacAdam 2step	SPHWAHDNC23YZR2D2	1707	174		
		MacAdam 3step	SPHWAHDNC23YZR3D2				
	80+	2700	MacAdam 1step			SPHWAHDNC25YZW1D2	
			MacAdam 2step	SPHWAHDNC25YZW2D2			
			MacAdam 3step	SPHWAHDNC25YZW3D2			
		3000	MacAdam 1step	SPHWAHDNC25YZV1D2	1418	152	
			MacAdam 2step	SPHWAHDNC25YZV2D2			
			MacAdam 3step	SPHWAHDNC25YZV3D2			
	90+	3500	MacAdam 1step	SPHWAHDNC25YZU1D2	1459	156	
			MacAdam 2step	SPHWAHDNC25YZU2D2			
			MacAdam 3step	SPHWAHDNC25YZU3D2			
		4000	MacAdam 1step	SPHWAHDNC25YZT1D2	1494	160	
			MacAdam 2step	SPHWAHDNC25YZT2D2			
			MacAdam 3step	SPHWAHDNC25YZT3D2			
	90+	5000	MacAdam 2step	SPHWAHDNC25YZR2D2	1506	161	
			MacAdam 3step	SPHWAHDNC25YZR3D2			
			MacAdam 2step	SPHWAHDNC25YZQ2D2			
		MacAdam 3step	SPHWAHDNC25YZQ3D2				
		6500	MacAdam 2step	SPHWAHDNC25YZP2D2	1488	159	
			MacAdam 3step	SPHWAHDNC25YZP3D2			
2700	MacAdam 1step		SPHWAHDNC27YZW1D2	1152			123
	MacAdam 2step	SPHWAHDNC27YZW2D2					
	MacAdam 3step	SPHWAHDNC27YZW3D2					
3000	MacAdam 1step	SPHWAHDNC27YZV1D2	1206	129			
	MacAdam 2step	SPHWAHDNC27YZV2D2					
	MacAdam 3step	SPHWAHDNC27YZV3D2					
90+	3500	MacAdam 1step	SPHWAHDNC27YZU1D2	1245	133		
		MacAdam 2step	SPHWAHDNC27YZU2D2				
		MacAdam 3step	SPHWAHDNC27YZU3D2				
	4000	MacAdam 1step	SPHWAHDNC27YZT1D2	1273	136		
		MacAdam 2step	SPHWAHDNC27YZT2D2				
		MacAdam 3step	SPHWAHDNC27YZT3D2				
5000	MacAdam 2step	SPHWAHDNC27YZR2D2	1278	137			
	MacAdam 3step	SPHWAHDNC27YZR3D2					

Chip-on-Board LEDs

Package

Product	CRI	CCT (K)	Color Rank	Part Number	T _J =85°C		I _F (mA) V _F (V)
					Luminous Flux Typ. (lm)	Luminous Efficacy Typ. (lm/W)	
LC013D Gen 2	70+	3000	MacAdam 2step	SPHWHAHNDND23YZV2D2	2106	161	360mA 34.6V
			MacAdam 3step	SPHWHAHNDND23YZV3D2			
		4000	MacAdam 2step	SPHWHAHNDND23YZT2D2	2173	166	
			MacAdam 3step	SPHWHAHNDND23YZT3D2			
		5000	MacAdam 2step	SPHWHAHNDND23YZR2D2	2207	169	
			MacAdam 3step	SPHWHAHNDND23YZR3D2			
	2700	MacAdam 1step	SPHWHAHNDND25YZW1D2	1764	142		
		MacAdam 2step	SPHWHAHNDND25YZW2D2				
		MacAdam 3step	SPHWHAHNDND25YZW3D2				
	3000	MacAdam 1step	SPHWHAHNDND25YZV1D2	1857	149		
		MacAdam 2step	SPHWHAHNDND25YZV2D2				
		MacAdam 3step	SPHWHAHNDND25YZV3D2				
80+	3500	MacAdam 1step	SPHWHAHNDND25YZU1D2	1915	154		
		MacAdam 2step	SPHWHAHNDND25YZU2D2				
		MacAdam 3step	SPHWHAHNDND25YZU3D2				
	4000	MacAdam 1step	SPHWHAHNDND25YZT1D2	1950	157		
		MacAdam 2step	SPHWHAHNDND25YZT2D2				
		MacAdam 3step	SPHWHAHNDND25YZT3D2				
5000	MacAdam 2step	SPHWHAHNDND25YZR2D2	1967	158			
	MacAdam 3step	SPHWHAHNDND25YZR3D2					
	MacAdam 1step	SPHWHAHNDND25YZQ2D2			1967	158	
MacAdam 3step	SPHWHAHNDND25YZQ3D2						
90+	6500	MacAdam 2step	SPHWHAHNDND25YZP2D2	1938	156		
		MacAdam 3step	SPHWHAHNDND25YZP3D2				
		MacAdam 1step	SPHWHAHNDND27YZW1D2			1509	121
	MacAdam 2step	SPHWHAHNDND27YZW2D2					
	MacAdam 3step	SPHWHAHNDND27YZW3D2					
	95+	3000	MacAdam 1step	SPHWHAHNDND27YZV1D2	1580	127	
MacAdam 2step			SPHWHAHNDND27YZV2D2				
MacAdam 3step			SPHWHAHNDND27YZV3D2				
3500		MacAdam 1step	SPHWHAHNDND27YZU1D2	1635	131		
		MacAdam 2step	SPHWHAHNDND27YZU2D2				
		MacAdam 3step	SPHWHAHNDND27YZU3D2				
4000	MacAdam 1step	SPHWHAHNDND27YZT1D2	1670	134			
	MacAdam 2step	SPHWHAHNDND27YZT2D2					
	MacAdam 3step	SPHWHAHNDND27YZT3D2					
5000	MacAdam 2step	SPHWHAHNDND27YZR2D2	1674	134			
	MacAdam 3step	SPHWHAHNDND27YZR3D2					
	MacAdam 1step	SPHWHAHNDND28YZW1D2			1223	98	
MacAdam 2step	SPHWHAHNDND28YZW2D2						
MacAdam 3step	SPHWHAHNDND28YZW3D2						
95+	3000	MacAdam 1step	SPHWHAHNDND28YZV1D2	1285	103		
		MacAdam 2step	SPHWHAHNDND28YZV2D2				
		MacAdam 3step	SPHWHAHNDND28YZV3D2				
	3500	MacAdam 1step	SPHWHAHNDND28YZU1D2	1337	107		
		MacAdam 2step	SPHWHAHNDND28YZU2D2				
		MacAdam 3step	SPHWHAHNDND28YZU3D2				
4000	MacAdam 1step	SPHWHAHNDND28YZT1D2	1379	111			
	MacAdam 2step	SPHWHAHNDND28YZT2D2					
	MacAdam 3step	SPHWHAHNDND28YZT3D2					
5000	MacAdam 2step	SPHWHAHNDND28YZR2D2	1390	112			
	MacAdam 3step	SPHWHAHNDND28YZR3D2					

Chip-on-Board LEDs

Package

Product	CRI	CCT (K)	Color Rank	Part Number	T _J =85°C		I _F (mA) V _F (V)
					Luminous Flux Typ. (lm)	Luminous Efficacy Typ. (lm/W)	
LC016D Gen 2	70+	3000	MacAdam 2step	SPHWHAHNDNE23YZV2D2	2617	168	450mA 34.6V
			MacAdam 3step	SPHWHAHNDNE23YZV3D2			
		4000	MacAdam 2step	SPHWHAHNDNE23YZT2D2	2701	173	
			MacAdam 3step	SPHWHAHNDNE23YZT3D2			
		5000	MacAdam 2step	SPHWHAHNDNE23YZR2D2	2742	176	
			MacAdam 3step	SPHWHAHNDNE23YZR3D2			
	2700	MacAdam 1step	SPHWHAHNDNE25YZW1D2	2293	147		
		MacAdam 2step	SPHWHAHNDNE25YZW2D2				
		MacAdam 3step	SPHWHAHNDNE25YZW3D2				
	3000	MacAdam 1step	SPHWHAHNDNE25YZV1D2	2423	156		
		MacAdam 2step	SPHWHAHNDNE25YZV2D2				
		MacAdam 3step	SPHWHAHNDNE25YZV3D2				
80+	3500	MacAdam 1step	SPHWHAHNDNE25YZU1D2	2513	161		
		MacAdam 2step	SPHWHAHNDNE25YZU2D2				
		MacAdam 3step	SPHWHAHNDNE25YZU3D2				
	4000	MacAdam 1step	SPHWHAHNDNE25YZT1D2	2558	164		
		MacAdam 2step	SPHWHAHNDNE25YZT2D2				
		MacAdam 3step	SPHWHAHNDNE25YZT3D2				
5000	MacAdam 2step	SPHWHAHNDNE25YZR2D2	2581	166			
	MacAdam 3step	SPHWHAHNDNE25YZR3D2					
	MacAdam 1step	SPHWHAHNDNE25YZQ2D2			2581	166	
MacAdam 3step	SPHWHAHNDNE25YZQ3D2						
90+	6500	MacAdam 2step	SPHWHAHNDNE25YZP2D2	2558	164		
		MacAdam 3step	SPHWHAHNDNE25YZP3D2				
		MacAdam 1step	SPHWHAHNDNE27YZW1D2			1967	126
	MacAdam 2step	SPHWHAHNDNE27YZW2D2					
	MacAdam 3step	SPHWHAHNDNE27YZW3D2					
	95+	3000	MacAdam 1step	SPHWHAHNDNE27YZV1D2	2084	134	
MacAdam 2step			SPHWHAHNDNE27YZV2D2				
MacAdam 3step			SPHWHAHNDNE27YZV3D2				
3500		MacAdam 1step	SPHWHAHNDNE27YZU1D2	2146	138		
		MacAdam 2step	SPHWHAHNDNE27YZU2D2				
		MacAdam 3step	SPHWHAHNDNE27YZU3D2				
4000	MacAdam 1step	SPHWHAHNDNE27YZT1D2	2189	141			
	MacAdam 2step	SPHWHAHNDNE27YZT2D2					
	MacAdam 3step	SPHWHAHNDNE27YZT3D2					
5000	MacAdam 2step	SPHWHAHNDNE27YZR2D2	2209	142			
	MacAdam 3step	SPHWHAHNDNE27YZR3D2					
	MacAdam 1step	SPHWHAHNDNE28YZW1D2			1575	101	
MacAdam 2step	SPHWHAHNDNE28YZW2D2						
MacAdam 3step	SPHWHAHNDNE28YZW3D2						
95+	3000	MacAdam 1step	SPHWHAHNDNE28YZV1D2	1655	106		
		MacAdam 2step	SPHWHAHNDNE28YZV2D2				
		MacAdam 3step	SPHWHAHNDNE28YZV3D2				
	3500	MacAdam 1step	SPHWHAHNDNE28YZU1D2	1722	111		
		MacAdam 2step	SPHWHAHNDNE28YZU2D2				
		MacAdam 3step	SPHWHAHNDNE28YZU3D2				
4000	MacAdam 1step	SPHWHAHNDNE28YZT1D2	1776	114			
	MacAdam 2step	SPHWHAHNDNE28YZT2D2					
	MacAdam 3step	SPHWHAHNDNE28YZT3D2					
5000	MacAdam 2step	SPHWHAHNDNE28YZR2D2	1791	115			
	MacAdam 3step	SPHWHAHNDNE28YZR3D2					

Chip-on-Board LEDs

Package

Product	CRI	CCT (K)	Color Rank	Part Number	T _J =85°C		I _F (mA) V _F (V)
					Luminous Flux Typ. (lm)	Luminous Efficacy Typ. (lm/W)	
LC019D Gen 2	70+	3000	MacAdam 2step	SPHWAHDNF23YZV2D2	3107	166	540mA 34.6V
			MacAdam 3step	SPHWAHDNF23YZV3D2			
		4000	MacAdam 2step	SPHWAHDNF23YZT2D2	3207	172	
			MacAdam 3step	SPHWAHDNF23YZT3D2			
		5000	MacAdam 2step	SPHWAHDNF23YZR2D2	3256	174	
			MacAdam 3step	SPHWAHDNF23YZR3D2			
	2700	MacAdam 1step	SPHWAHDNF25YZW1D2	2728	146		
		MacAdam 2step	SPHWAHDNF25YZW2D2				
		MacAdam 3step	SPHWAHDNF25YZW3D2				
	80+	3000	MacAdam 1step	SPHWAHDNF25YZV1D2	2877	154	
			MacAdam 2step	SPHWAHDNF25YZV2D2			
		3500	MacAdam 2step	SPHWAHDNF25YZU2D2	2965	159	
MacAdam 3step			SPHWAHDNF25YZU3D2				
4000		MacAdam 1step	SPHWAHDNF25YZT1D2	3026	162		
		MacAdam 2step	SPHWAHDNF25YZT2D2				
	MacAdam 3step	SPHWAHDNF25YZT3D2					
90+	5000	MacAdam 2step	SPHWAHDNF25YZR2D2	3059	164		
		MacAdam 3step	SPHWAHDNF25YZR3D2				
	5700	MacAdam 2step	SPHWAHDNF25YZQ2D2	3059	164		
		MacAdam 3step	SPHWAHDNF25YZQ3D2				
	6500	MacAdam 2step	SPHWAHDNF25YZP2D2	3026	162		
		MacAdam 3step	SPHWAHDNF25YZP3D2				
MacAdam 1step		SPHWAHDNF27YZW1D2					
95+	2700	MacAdam 2step	SPHWAHDNF27YZW2D2	2336	125		
		MacAdam 3step	SPHWAHDNF27YZW3D2				
	3000	MacAdam 1step	SPHWAHDNF27YZV1D2	2449	131		
		MacAdam 2step	SPHWAHDNF27YZV2D2				
	3500	MacAdam 3step	SPHWAHDNF27YZV3D2	2539	136		
		MacAdam 1step	SPHWAHDNF27YZU1D2				
MacAdam 2step		SPHWAHDNF27YZU2D2					
95+	4000	MacAdam 3step	SPHWAHDNF27YZU3D2	2594	139		
		MacAdam 1step	SPHWAHDNF27YZT1D2				
	5000	MacAdam 2step	SPHWAHDNF27YZT2D2	2596	139		
		MacAdam 3step	SPHWAHDNF27YZT3D2				
	2700	MacAdam 2step	SPHWAHDNF27YZR2D2	1880	101		
		MacAdam 3step	SPHWAHDNF27YZR3D2				
MacAdam 1step		SPHWAHDNF28YZW1D2					
95+	3000	MacAdam 2step	SPHWAHDNF28YZW2D2	1976	106		
		MacAdam 3step	SPHWAHDNF28YZW3D2				
	3500	MacAdam 1step	SPHWAHDNF28YZV1D2	2056	110		
		MacAdam 2step	SPHWAHDNF28YZV2D2				
	4000	MacAdam 3step	SPHWAHDNF28YZV3D2	2121	114		
		MacAdam 1step	SPHWAHDNF28YZU1D2				
MacAdam 2step		SPHWAHDNF28YZU2D2					
5000	MacAdam 3step	SPHWAHDNF28YZU3D2	2138	114			
	MacAdam 1step	SPHWAHDNF28YZT1D2					
	MacAdam 2step	SPHWAHDNF28YZT2D2					

Chip-on-Board LEDs

Package

Product	CRI	CCT (K)	Color Rank	Part Number	T _J =85°C		I _F (mA) V _F (V)
					Luminous Flux Typ. (lm)	Luminous Efficacy Typ. (lm/W)	
LC026D Gen 2	70+	3000	MacAdam 2step	SPHWAHDNG23YZV2D2	4063	163	720mA 34.6V
			MacAdam 3step	SPHWAHDNG23YZV3D2			
		4000	MacAdam 2step	SPHWAHDNG23YZT2D2	4193	168	
			MacAdam 3step	SPHWAHDNG23YZT3D2			
		5000	MacAdam 2step	SPHWAHDNG23YZR2D2	4258	171	
			MacAdam 3step	SPHWAHDNG23YZR3D2			
	2700	MacAdam 1step	SPHWAHDNG25YZW1D2	3580	144		
		MacAdam 2step	SPHWAHDNG25YZW2D2				
		MacAdam 3step	SPHWAHDNG25YZW3D2				
	80+	3000	MacAdam 1step	SPHWAHDNG25YZV1D2	3762	151	
			MacAdam 2step	SPHWAHDNG25YZV2D2			
		3500	MacAdam 3step	SPHWAHDNG25YZV3D2	3872	155	
MacAdam 1step			SPHWAHDNG25YZU1D2				
4000		MacAdam 2step	SPHWAHDNG25YZU2D2	3950	159		
		MacAdam 3step	SPHWAHDNG25YZU3D2				
	MacAdam 1step	SPHWAHDNG25YZT1D2					
90+	5000	MacAdam 2step	SPHWAHDNG25YZT2D2	3983	160		
		MacAdam 3step	SPHWAHDNG25YZT3D2				
	5700	MacAdam 2step	SPHWAHDNG25YZR2D2	3983	160		
		MacAdam 3step	SPHWAHDNG25YZR3D2				
	6500	MacAdam 2step	SPHWAHDNG25YZQ2D2	3950	159		
		MacAdam 3step	SPHWAHDNG25YZQ3D2				
MacAdam 1step		SPHWAHDNG25YZP2D2					
95+	2700	MacAdam 3step	SPHWAHDNG25YZP3D2	3064	123		
		MacAdam 2step	SPHWAHDNG27YZW2D2				
	3000	MacAdam 3step	SPHWAHDNG27YZW3D2	3223	129		
		MacAdam 1step	SPHWAHDNG27YZV1D2				
	3500	MacAdam 2step	SPHWAHDNG27YZV2D2	3319	133		
		MacAdam 3step	SPHWAHDNG27YZV3D2				
MacAdam 1step		SPHWAHDNG27YZU1D2					
95+	4000	MacAdam 2step	SPHWAHDNG27YZU2D2	3387	136		
		MacAdam 3step	SPHWAHDNG27YZU3D2				
	5000	MacAdam 1step	SPHWAHDNG27YZT1D2	3416	137		
		MacAdam 2step	SPHWAHDNG27YZT2D2				
	2700	MacAdam 3step	SPHWAHDNG27YZT3D2	2470	99		
		MacAdam 1step	SPHWAHDNG27YZR2D2				
MacAdam 2step		SPHWAHDNG27YZR3D2					
95+	3000	MacAdam 1step	SPHWAHDNG28YZW1D2	2596	104		
		MacAdam 2step	SPHWAHDNG28YZW2D2				
	3500	MacAdam 3step	SPHWAHDNG28YZW3D2	2701	108		
		MacAdam 1step	SPHWAHDNG28YZV1D2				
	4000	MacAdam 2step	SPHWAHDNG28YZV2D2	2786	112		
		MacAdam 3step	SPHWAHDNG28YZV3D2				
MacAdam 1step		SPHWAHDNG28YZU1D2					
5000	MacAdam 2step	SPHWAHDNG28YZU2D2	2809	113			
	MacAdam 3step	SPHWAHDNG28YZU3D2					
	MacAdam 1step	SPHWAHDNG28YZT1D2					

Chip-on-Board LEDs

Package

Product	CRI	CCT (K)	Color Rank	Part Number	T _J =85°C		I _F (mA) V _F (V)
					Luminous Flux Typ. (lm)	Luminous Efficacy Typ. (lm/W)	
LC033D Gen 2	70+	3000	MacAdam 2step	SPHWAHDNH23YZV2D2	5014	161	900mA 34.6V
			MacAdam 3step	SPHWAHDNH23YZV3D2			
		4000	MacAdam 2step	SPHWAHDNH23YZT2D2	5175	166	
			MacAdam 3step	SPHWAHDNH23YZT3D2			
		5000	MacAdam 2step	SPHWAHDNH23YZR2D2	5255	169	
			MacAdam 3step	SPHWAHDNH23YZR3D2			
	2700	MacAdam 1step	SPHWAHDNH25YZW1D2	4418	142		
		MacAdam 2step	SPHWAHDNH25YZW2D2				
		MacAdam 3step	SPHWAHDNH25YZW3D2				
	3000	MacAdam 1step	SPHWAHDNH25YZV1D2	4643	149		
		MacAdam 2step	SPHWAHDNH25YZV2D2				
		MacAdam 3step	SPHWAHDNH25YZV3D2				
3500	MacAdam 1step	SPHWAHDNH25YZU1D2	4779	153			
	MacAdam 2step	SPHWAHDNH25YZU2D2					
	MacAdam 3step	SPHWAHDNH25YZU3D2					
4000	MacAdam 1step	SPHWAHDNH25YZT1D2	4875	157			
	MacAdam 2step	SPHWAHDNH25YZT2D2					
	MacAdam 3step	SPHWAHDNH25YZT3D2					
5000	MacAdam 2step	SPHWAHDNH25YZR2D2	4916	158			
	MacAdam 3step	SPHWAHDNH25YZR3D2					
	MacAdam 1step	SPHWAHDNH25YZQ2D2					
5700	MacAdam 2step	SPHWAHDNH25YZQ2D2	4916	158			
	MacAdam 3step	SPHWAHDNH25YZQ3D2					
	MacAdam 1step	SPHWAHDNH25YZP2D2					
6500	MacAdam 2step	SPHWAHDNH25YZP2D2	4875	157			
	MacAdam 3step	SPHWAHDNH25YZP3D2					
	MacAdam 1step	SPHWAHDNH27YZW1D2					
2700	MacAdam 2step	SPHWAHDNH27YZW2D2	3781	121			
	MacAdam 3step	SPHWAHDNH27YZW2D2					
	MacAdam 1step	SPHWAHDNH27YZV1D2					
3000	MacAdam 2step	SPHWAHDNH27YZV2D2	3977	128			
	MacAdam 3step	SPHWAHDNH27YZV3D2					
	MacAdam 1step	SPHWAHDNH27YZU1D2					
3500	MacAdam 2step	SPHWAHDNH27YZU2D2	4096	132			
	MacAdam 3step	SPHWAHDNH27YZU3D2					
	MacAdam 1step	SPHWAHDNH27YZT1D2					
4000	MacAdam 2step	SPHWAHDNH27YZT2D2	4180	134			
	MacAdam 3step	SPHWAHDNH27YZT3D2					
	MacAdam 1step	SPHWAHDNH27YZR2D2					
5000	MacAdam 2step	SPHWAHDNH27YZR2D2	4216	135			
	MacAdam 3step	SPHWAHDNH27YZR3D2					
	MacAdam 1step	SPHWAHDNH28YZW1D2					
2700	MacAdam 2step	SPHWAHDNH28YZW2D2	3057	98			
	MacAdam 3step	SPHWAHDNH28YZW3D2					
	MacAdam 1step	SPHWAHDNH28YZV1D2					
3000	MacAdam 2step	SPHWAHDNH28YZV2D2	3212	103			
	MacAdam 3step	SPHWAHDNH28YZV3D2					
	MacAdam 1step	SPHWAHDNH28YZU1D2					
3500	MacAdam 2step	SPHWAHDNH28YZU2D2	3343	107			
	MacAdam 3step	SPHWAHDNH28YZU3D2					
	MacAdam 1step	SPHWAHDNH28YZT1D2					
4000	MacAdam 2step	SPHWAHDNH28YZT2D2	3447	111			
	MacAdam 3step	SPHWAHDNH28YZT3D2					
	MacAdam 1step	SPHWAHDNH28YZR2D2					
5000	MacAdam 2step	SPHWAHDNH28YZR2D2	3476	112			
	MacAdam 3step	SPHWAHDNH28YZR3D2					

Chip-on-Board LEDs

Package

Product	CRI	CCT (K)	Color Rank	Part Number	T _J =85°C		I _F (mA) V _F (V)
					Luminous Flux Typ. (lm)	Luminous Efficacy Typ. (lm/W)	
LC040D Gen 2	70+	3000	MacAdam 2step	SPHWAHDNK23YZV2D2	6304	169	1080mA 34.6V
			MacAdam 3step	SPHWAHDNK23YZV3D2			
		4000	MacAdam 2step	SPHWAHDNK23YZT2D2	6506	174	
			MacAdam 3step	SPHWAHDNK23YZT3D2			
		5000	MacAdam 2step	SPHWAHDNK23YZR2D2	6607	177	
			MacAdam 3step	SPHWAHDNK23YZR3D2			
	2700	MacAdam 1step	SPHWAHDNK25YZW1D2	5547	148		
		MacAdam 2step	SPHWAHDNK25YZW2D2				
		MacAdam 3step	SPHWAHDNK25YZW3D2				
	3000	MacAdam 1step	SPHWAHDNK25YZV1D2	5837	156		
		MacAdam 2step	SPHWAHDNK25YZV2D2				
		MacAdam 3step	SPHWAHDNK25YZV3D2				
3500	MacAdam 1step	SPHWAHDNK25YZU1D2	6016	161			
	MacAdam 2step	SPHWAHDNK25YZU2D2					
	MacAdam 3step	SPHWAHDNK25YZU3D2					
4000	MacAdam 1step	SPHWAHDNK25YZT1D2	6146	164			
	MacAdam 2step	SPHWAHDNK25YZT2D2					
	MacAdam 3step	SPHWAHDNK25YZT3D2					
5000	MacAdam 2step	SPHWAHDNK25YZR2D2	6175	165			
	MacAdam 3step	SPHWAHDNK25YZR3D2					
	MacAdam 1step	SPHWAHDNK25YZQ2D2					
5700	MacAdam 2step	SPHWAHDNK25YZQ2D2	6205	166			
	MacAdam 3step	SPHWAHDNK25YZQ3D2					
	MacAdam 1step	SPHWAHDNK25YZP2D2					
6500	MacAdam 2step	SPHWAHDNK25YZP2D2	6138	164			
	MacAdam 3step	SPHWAHDNK25YZP3D2					
	MacAdam 1step	SPHWAHDNK27YZW1D2					
2700	MacAdam 2step	SPHWAHDNK27YZW2D2	4755	127			
	MacAdam 3step	SPHWAHDNK27YZW3D2					
	MacAdam 1step	SPHWAHDNK27YZV1D2					
3000	MacAdam 2step	SPHWAHDNK27YZV2D2	5024	134			
	MacAdam 3step	SPHWAHDNK27YZV3D2					
	MacAdam 1step	SPHWAHDNK27YZU1D2					
3500	MacAdam 2step	SPHWAHDNK27YZU2D2	5152	138			
	MacAdam 3step	SPHWAHDNK27YZU3D2					
	MacAdam 1step	SPHWAHDNK27YZT1D2					
4000	MacAdam 2step	SPHWAHDNK27YZT2D2	5266	141			
	MacAdam 3step	SPHWAHDNK27YZT3D2					
	MacAdam 1step	SPHWAHDNK27YZR2D2					
5000	MacAdam 2step	SPHWAHDNK27YZR2D2	5325	143			
	MacAdam 3step	SPHWAHDNK27YZR3D2					
	MacAdam 1step	SPHWAHDNK28YZW1D2					
2700	MacAdam 2step	SPHWAHDNK28YZW2D2	3760	101			
	MacAdam 3step	SPHWAHDNK28YZW3D2					
	MacAdam 1step	SPHWAHDNK28YZV1D2					
3000	MacAdam 2step	SPHWAHDNK28YZV2D2	3952	106			
	MacAdam 3step	SPHWAHDNK28YZV3D2					
	MacAdam 1step	SPHWAHDNK28YZU1D2					
3500	MacAdam 2step	SPHWAHDNK28YZU2D2	4113	110			
	MacAdam 3step	SPHWAHDNK28YZU3D2					
	MacAdam 1step	SPHWAHDNK28YZT1D2					
4000	MacAdam 2step	SPHWAHDNK28YZT2D2	4241	113			
	MacAdam 3step	SPHWAHDNK28YZT3D2					
	MacAdam 1step	SPHWAHDNK28YZR2D2					
5000	MacAdam 2step	SPHWAHDNK28YZR2D2	4277	114			
	MacAdam 3step	SPHWAHDNK28YZR3D2					

Chip-on-Board LEDs

Package

Product	CRI	CCT (K)	Color Rank	Part Number	T _j =85°C		I _F (mA) V _F (V)
					Luminous Flux Typ. (lm)	Luminous Efficacy Typ. (lm/W)	
LC060D Gen 2	70+	3000	MacAdam 2step	SPHWAHDNL231ZV2D2	9225	164	1080mA 52.0V
			MacAdam 3step	SPHWAHDNL231ZV3D2			
		4000	MacAdam 2step	SPHWAHDNL231ZT2D2	9521	170	
			MacAdam 3step	SPHWAHDNL231ZT3D2			
		5000	MacAdam 2step	SPHWAHDNL231ZR2D2	9668	172	
			MacAdam 3step	SPHWAHDNL231ZR3D2			
	2700	MacAdam 1step	SPHWAHDNL251ZW1D2	8107	144		
		MacAdam 2step	SPHWAHDNL251ZW2D2				
		MacAdam 3step	SPHWAHDNL251ZW3D2				
	80+	3000	MacAdam 1step	SPHWAHDNL251ZV1D2	8542	152	
			MacAdam 2step	SPHWAHDNL251ZV2D2			
			MacAdam 3step	SPHWAHDNL251ZV3D2			
3500		MacAdam 1step	SPHWAHDNL251ZU1D2	8812	157		
		MacAdam 2step	SPHWAHDNL251ZU2D2				
		MacAdam 3step	SPHWAHDNL251ZU3D2				
90+	4000	MacAdam 1step	SPHWAHDNL251ZT1D2	8995	160		
		MacAdam 2step	SPHWAHDNL251ZT2D2				
		MacAdam 3step	SPHWAHDNL251ZT3D2				
	5000	MacAdam 2step	SPHWAHDNL251ZR2D2	9039	161		
		MacAdam 3step	SPHWAHDNL251ZR3D2				
		MacAdam 2step	SPHWAHDNL251ZQ2D2			9084	162
MacAdam 3step	SPHWAHDNL251ZQ3D2						
2700	6500	MacAdam 2step	SPHWAHDNL251ZP2D2	8990	160		
		MacAdam 3step	SPHWAHDNL251ZP3D2				
		MacAdam 1step	SPHWAHDNL271ZW1D2			6959	124
	MacAdam 2step	SPHWAHDNL271ZW2D2					
	MacAdam 3step	SPHWAHDNL271ZW3D2					
	3000	MacAdam 1step	SPHWAHDNL271ZV1D2	7352	131		
MacAdam 2step			SPHWAHDNL271ZV2D2				
MacAdam 3step			SPHWAHDNL271ZV3D2				
3500		MacAdam 1step	SPHWAHDNL271ZU1D2	7539	134		
		MacAdam 2step	SPHWAHDNL271ZU2D2				
		MacAdam 3step	SPHWAHDNL271ZU3D2				
4000	MacAdam 1step	SPHWAHDNL271ZT1D2	7706	137			
	MacAdam 2step	SPHWAHDNL271ZT2D2					
	MacAdam 3step	SPHWAHDNL271ZT3D2					
5000	MacAdam 2step	SPHWAHDNL271ZR2D2	7793	139			
	MacAdam 3step	SPHWAHDNL271ZR3D2					



LC060D Gen 2

Chip-on-Board LEDs

Package

Product	CRI	CCT (K)	Color Rank	Part Number	T _j =85°C		I _F (mA) V _F (V)
					Luminous Flux Typ. (lm)	Luminous Efficacy Typ. (lm/W)	
LC080D Gen 2	70+	3000	MacAdam 2step	SPHWAHDNM231ZV2D2	13465	160	1620mA 52.0V
			MacAdam 3step	SPHWAHDNM231ZV3D2			
		4000	MacAdam 2step	SPHWAHDNM231ZT2D2	13896	165	
			MacAdam 3step	SPHWAHDNM231ZT3D2			
		5000	MacAdam 2step	SPHWAHDNM231ZR2D2	14112	168	
			MacAdam 3step	SPHWAHDNM231ZR3D2			
	2700	MacAdam 1step	SPHWAHDNM251ZW1D2	11815	140		
		MacAdam 2step	SPHWAHDNM251ZW2D2				
		MacAdam 3step	SPHWAHDNM251ZW3D2				
	80+	3000	MacAdam 1step	SPHWAHDNM251ZV1D2	12468	148	
			MacAdam 2step	SPHWAHDNM251ZV2D2			
			MacAdam 3step	SPHWAHDNM251ZV3D2			
3500		MacAdam 1step	SPHWAHDNM251ZU1D2	12852	153		
		MacAdam 2step	SPHWAHDNM251ZU2D2				
		MacAdam 3step	SPHWAHDNM251ZU3D2				
90+	4000	MacAdam 1step	SPHWAHDNM251ZT1D2	13123	156		
		MacAdam 2step	SPHWAHDNM251ZT2D2				
		MacAdam 3step	SPHWAHDNM251ZT3D2				
	5000	MacAdam 2step	SPHWAHDNM251ZR2D2	13196	157		
		MacAdam 3step	SPHWAHDNM251ZR3D2				
		MacAdam 2step	SPHWAHDNM251ZQ2D2			13258	157
MacAdam 3step	SPHWAHDNM251ZQ3D2						
2700	6500	MacAdam 2step	SPHWAHDNM251ZP2D2	13121	156		
		MacAdam 3step	SPHWAHDNM251ZP3D2				
		MacAdam 1step	SPHWAHDNM271ZW1D2			10157	121
	MacAdam 2step	SPHWAHDNM271ZW2D2					
	MacAdam 3step	SPHWAHDNM271ZW3D2					
	3000	MacAdam 1step	SPHWAHDNM271ZV1D2	10731	127		
MacAdam 2step		SPHWAHDNM271ZV2D2					
MacAdam 3step		SPHWAHDNM271ZV3D2					
3500	MacAdam 1step	SPHWAHDNM271ZU1D2	11004	131			
		MacAdam 2step			SPHWAHDNM271ZU2D2		
		MacAdam 3step			SPHWAHDNM271ZU3D2		
	4000	MacAdam 1step	SPHWAHDNM271ZT1D2	11247	134		
		MacAdam 2step	SPHWAHDNM271ZT2D2				
		MacAdam 3step	SPHWAHDNM271ZT3D2				
5000	MacAdam 2step	SPHWAHDNM271ZR2D2	11375	135			
	MacAdam 3step	SPHWAHDNM271ZR3D2					



LC080D Gen 2

Chip-on-Board LEDs

Package

Product	CRI	CCT (K)	Color Rank	Part Number	T _J =85°C		I _F (mA) V _F (V)
					Luminous Flux Typ. (lm)	Luminous Efficacy Typ. (lm/W)	
LC006D Gen 2+	80+	2700	MacAdam 1step	SPHWAHDNB25YZW1DB	928	152	180mA 34V
			MacAdam 2step	SPHWAHDNB25YZW2DB			
			MacAdam 3step	SPHWAHDNB25YZW3DB			
	3000	MacAdam 1step	SPHWAHDNB25YZV1DB	971	159		
		MacAdam 2step	SPHWAHDNB25YZV2DB				
		MacAdam 3step	SPHWAHDNB25YZV3DB				
	3500	MacAdam 1step	SPHWAHDNB25YZU1DB	1001	164		
		MacAdam 2step	SPHWAHDNB25YZU2DB				
		MacAdam 3step	SPHWAHDNB25YZU3DB				
	4000	MacAdam 1step	SPHWAHDNB25YZT1DB	1024	167		
		MacAdam 2step	SPHWAHDNB25YZT2DB				
		MacAdam 3step	SPHWAHDNB25YZT3DB				
	5000	MacAdam 2step	SPHWAHDNB25YZR2DB	1020	167		
		MacAdam 3step	SPHWAHDNB25YZR3DB				
		MacAdam 2step	SPHWAHDNB25YZQ2DB			1010	
	MacAdam 3step	SPHWAHDNB25YZQ3DB					
	6500	MacAdam 2step	SPHWAHDNB25YZP2DB	1008	165		
		MacAdam 3step	SPHWAHDNB25YZP3DB				
2700		MacAdam 1step	SPHWAHDNB27YZW1DB			786	128
	MacAdam 2step	SPHWAHDNB27YZW2DB					
	MacAdam 3step	SPHWAHDNB27YZW3DB					
3000	MacAdam 1step	SPHWAHDNB27YZV1DB	824	135			
	MacAdam 2step	SPHWAHDNB27YZV2DB					
	MacAdam 3step	SPHWAHDNB27YZV3DB					
3500	MacAdam 1step	SPHWAHDNB27YZU1DB	853	139			
	MacAdam 2step	SPHWAHDNB27YZU2DB					
	MacAdam 3step	SPHWAHDNB27YZU3DB					
4000	MacAdam 1step	SPHWAHDNB27YZT1DB	870	142			
	MacAdam 2step	SPHWAHDNB27YZT2DB					
	MacAdam 3step	SPHWAHDNB27YZT3DB					
5000	MacAdam 2step	SPHWAHDNB27YZR2DB	878	143			
	MacAdam 3step	SPHWAHDNB27YZR3DB					



LC006D Gen 2+

Chip-on-Board LEDs

Package

Product	CRI	CCT (K)	Color Rank	Part Number	T _J =85°C		I _F (mA) V _F (V)
					Luminous Flux Typ. (lm)	Luminous Efficacy Typ. (lm/W)	
LC009D Gen 2+	70+	3000	MacAdam 2step	SPHWAHDNC23YZV2DB	1548	161	270mA 34V
			MacAdam 3step	SPHWAHDNC23YZV3DB			
		4000	MacAdam 2step	SPHWAHDNC23YZT2DB	1591	169	
			MacAdam 3step	SPHWAHDNC23YZT3DB			
		5000	MacAdam 2step	SPHWAHDNC23YZR2DB	1626	174	
			MacAdam 3step	SPHWAHDNC23YZR3DB			
	80+	2700	MacAdam 1step	SPHWAHDNC25YZW1DB	1382	151	
			MacAdam 2step	SPHWAHDNC25YZW2DB			
		3000	MacAdam 1step	SPHWAHDNC25YZV1DB	1425	155	
			MacAdam 2step	SPHWAHDNC25YZV2DB			
		3500	MacAdam 1step	SPHWAHDNC25YZU1DB	1466	160	
			MacAdam 2step	SPHWAHDNC25YZU2DB			
	90+	4000	MacAdam 1step	SPHWAHDNC25YZT1DB	1502	164	
			MacAdam 2step	SPHWAHDNC25YZT2DB			
		5000	MacAdam 1step	SPHWAHDNC25YZR2DB	1513	165	
			MacAdam 2step	SPHWAHDNC25YZR3DB			
		5700	MacAdam 1step	SPHWAHDNC25YZQ2DB	1513	162	
			MacAdam 2step	SPHWAHDNC25YZQ3DB			
90+	6500	MacAdam 1step	SPHWAHDNC27YZW1DB	1158	126		
		MacAdam 2step	SPHWAHDNC27YZW2DB				
	2700	MacAdam 1step	SPHWAHDNC27YZV1DB	1212	132		
		MacAdam 2step	SPHWAHDNC27YZV2DB				
	3000	MacAdam 1step	SPHWAHDNC27YZU1DB	1257	137		
		MacAdam 2step	SPHWAHDNC27YZU2DB				
3500	MacAdam 1step	SPHWAHDNC27YZT1DB	1285	140			
	MacAdam 2step	SPHWAHDNC27YZT2DB					
4000	MacAdam 1step	SPHWAHDNC27YZR2DB	1304	142			
	MacAdam 2step	SPHWAHDNC27YZR3DB					



LC009D Gen 2+

Chip-on-Board LEDs

Package

Product	CRI	CCT (K)	Color Rank	Part Number	T _J =85°C		I _F (mA) V _F (V)
					Luminous Flux Typ. (lm)	Luminous Efficacy Typ. (lm/W)	
LC013D Gen 2+	70+	3000	MacAdam 2step	SPHWAHDND23YZV2DB	2006	164	360mA 34V
			MacAdam 3step	SPHWAHDND23YZV3DB			
		4000	MacAdam 2step	SPHWAHDND23YZT2DB	2070	169	
			MacAdam 3step	SPHWAHDND23YZT3DB			
		5000	MacAdam 2step	SPHWAHDND23YZR2DB	2060	168	
			MacAdam 3step	SPHWAHDND23YZR3DB			
	2700	MacAdam 1step	SPHWAHDND25YZW1DB	1773	145		
		MacAdam 2step	SPHWAHDND25YZW2DB				
	80+	3000	MacAdam 3step	SPHWAHDND25YZW3DB	1857	152	
			MacAdam 1step	SPHWAHDND25YZV1DB			
		3500	MacAdam 2step	SPHWAHDND25YZV2DB	1877	153	
			MacAdam 3step	SPHWAHDND25YZV3DB			
		4000	MacAdam 1step	SPHWAHDND25YZU1DB	1930	158	
			MacAdam 2step	SPHWAHDND25YZU2DB			
	MacAdam 3step		SPHWAHDND25YZU3DB				
	90+	4000	MacAdam 1step	SPHWAHDND25YZT1DB	1938	158	
			MacAdam 2step	SPHWAHDND25YZT2DB			
		5000	MacAdam 3step	SPHWAHDND25YZT3DB	1928	158	
			MacAdam 1step	SPHWAHDND25YZQ2DB			
		6500	MacAdam 2step	SPHWAHDND25YZQ3DB	1919	157	
			MacAdam 3step	SPHWAHDND25YZP2DB			
	70+	2700	MacAdam 1step	SPHWAHDND27YZW1DB	1486	121	
			MacAdam 2step	SPHWAHDND27YZW2DB			
		3000	MacAdam 3step	SPHWAHDND27YZW3DB	1556	127	
MacAdam 1step			SPHWAHDND27YZV1DB				
3500		MacAdam 2step	SPHWAHDND27YZV2DB	1635	134		
		MacAdam 3step	SPHWAHDND27YZV3DB				
		MacAdam 1step	SPHWAHDND27YZU1DB				
4000		MacAdam 2step	SPHWAHDND27YZU2DB	1670	136		
		MacAdam 3step	SPHWAHDND27YZU3DB				
		MacAdam 1step	SPHWAHDND27YZT1DB				
5000		MacAdam 2step	SPHWAHDND27YZT2DB	1674	137		
		MacAdam 3step	SPHWAHDND27YZT3DB				



LC013D Gen 2+

Chip-on-Board LEDs

Package

Product	CRI	CCT (K)	Color Rank	Part Number	T _J =85°C		I _F (mA) V _F (V)
					Luminous Flux Typ. (lm)	Luminous Efficacy Typ. (lm/W)	
LC016D Gen 2+	70+	3000	MacAdam 2step	SPHWAHDNE23YZV2DB	2617	171	450mA 34V
			MacAdam 3step	SPHWAHDNE23YZV3DB			
		4000	MacAdam 2step	SPHWAHDNE23YZT2DB	2674	175	
			MacAdam 3step	SPHWAHDNE23YZT3DB			
		5000	MacAdam 2step	SPHWAHDNE23YZR2DB	2688	176	
			MacAdam 3step	SPHWAHDNE23YZR3DB			
	2700	MacAdam 1step	SPHWAHDNE25YZW1DB	2305	151		
		MacAdam 2step	SPHWAHDNE25YZW2DB				
	80+	3000	MacAdam 3step	SPHWAHDNE25YZW3DB	2399	157	
			MacAdam 1step	SPHWAHDNE25YZV1DB			
		3500	MacAdam 2step	SPHWAHDNE25YZV2DB	2463	161	
			MacAdam 3step	SPHWAHDNE25YZV3DB			
		4000	MacAdam 1step	SPHWAHDNE25YZU1DB	2520	165	
			MacAdam 2step	SPHWAHDNE25YZU2DB			
	MacAdam 3step		SPHWAHDNE25YZU3DB				
	90+	4000	MacAdam 1step	SPHWAHDNE25YZT1DB	2529	165	
			MacAdam 2step	SPHWAHDNE25YZT2DB			
		5000	MacAdam 3step	SPHWAHDNE25YZT3DB	2529	165	
			MacAdam 1step	SPHWAHDNE25YZQ2DB			
		6500	MacAdam 2step	SPHWAHDNE25YZQ3DB	2507	164	
			MacAdam 3step	SPHWAHDNE25YZP2DB			
	70+	2700	MacAdam 1step	SPHWAHDNE27YZW1DB	1776	116	
			MacAdam 2step	SPHWAHDNE27YZW2DB			
		3000	MacAdam 3step	SPHWAHDNE27YZW3DB	1986	130	
MacAdam 1step			SPHWAHDNE27YZV1DB				
3500		MacAdam 2step	SPHWAHDNE27YZV2DB	2094	137		
		MacAdam 3step	SPHWAHDNE27YZV3DB				
		MacAdam 1step	SPHWAHDNE27YZU1DB				
4000		MacAdam 2step	SPHWAHDNE27YZU2DB	2156	141		
		MacAdam 3step	SPHWAHDNE27YZU3DB				
		MacAdam 1step	SPHWAHDNE27YZT1DB				
5000		MacAdam 2step	SPHWAHDNE27YZT2DB	2200	144		
		MacAdam 3step	SPHWAHDNE27YZT3DB				



LC016D Gen 2+

Chip-on-Board LEDs

Package

Product	CRI	CCT (K)	Color Rank	Part Number	T _J =85°C		I _F (mA) V _F (V)
					Luminous Flux Typ. (lm)	Luminous Efficacy Typ. (lm/W)	
 LC019D Gen 2+	70+	3000	MacAdam 2step	SPHWAHDNF23YZV2DB	3107	203	540mA 34V
			MacAdam 3step	SPHWAHDNF23YZV3DB			
		4000	MacAdam 2step	SPHWAHDNF23YZT2DB	3207	210	
			MacAdam 3step	SPHWAHDNF23YZT3DB			
		5000	MacAdam 2step	SPHWAHDNF23YZR2DB	3191	209	
			MacAdam 3step	SPHWAHDNF23YZR3DB			
	2700	MacAdam 1step	SPHWAHDNF25YZW1DB	2742	149		
		MacAdam 2step	SPHWAHDNF25YZW2DB				
		MacAdam 3step	SPHWAHDNF25YZW3DB				
	3000	MacAdam 1step	SPHWAHDNF25YZV1DB	2877	157		
		MacAdam 2step	SPHWAHDNF25YZV2DB				
		MacAdam 3step	SPHWAHDNF25YZV3DB				
	3500	MacAdam 1step	SPHWAHDNF25YZU1DB	2921	159		
		MacAdam 2step	SPHWAHDNF25YZU2DB				
		MacAdam 3step	SPHWAHDNF25YZU3DB				
	80+	4000	MacAdam 1step	SPHWAHDNF25YZT1DB	2996	163	
			MacAdam 2step	SPHWAHDNF25YZT2DB			
			MacAdam 3step	SPHWAHDNF25YZT3DB			
		5000	MacAdam 2step	SPHWAHDNF25YZR2DB	3013	164	
			MacAdam 3step	SPHWAHDNF25YZR3DB			
			MacAdam 2step	SPHWAHDNF25YZQ2DB			
	MacAdam 3step	SPHWAHDNF25YZQ3DB					
	6500	MacAdam 2step	SPHWAHDNF25YZP2DB	2966	162		
		MacAdam 3step	SPHWAHDNF25YZP3DB				
MacAdam 1step		SPHWAHDNF27YZW1DB	2301			125	
2700	MacAdam 2step	SPHWAHDNF27YZW2DB					
	MacAdam 3step	SPHWAHDNF27YZW3DB					
	3000	MacAdam 1step	SPHWAHDNF27YZV1DB	2413	131		
MacAdam 2step		SPHWAHDNF27YZV2DB					
MacAdam 3step		SPHWAHDNF27YZV3DB					
90+	3500	MacAdam 1step	SPHWAHDNF27YZU1DB	2526	138		
		MacAdam 2step	SPHWAHDNF27YZU2DB				
		MacAdam 3step	SPHWAHDNF27YZU3DB				
	4000	MacAdam 1step	SPHWAHDNF27YZT1DB	2581	141		
		MacAdam 2step	SPHWAHDNF27YZT2DB				
		MacAdam 3step	SPHWAHDNF27YZT3DB				
5000	MacAdam 2step	SPHWAHDNF27YZR2DB	2596	141			
	MacAdam 3step	SPHWAHDNF27YZR3DB					

Chip-on-Board LEDs

Package

Product	CRI	CCT (K)	Color Rank	Part Number	T _J =85°C		I _F (mA) V _F (V)
					Luminous Flux Typ. (lm)	Luminous Efficacy Typ. (lm/W)	
 LC026D Gen 2+	70+	3000	MacAdam 2step	SPHWAHDNG23YZV2DB	4063	166	720mA 34V
			MacAdam 3step	SPHWAHDNG23YZV3DB			
		4000	MacAdam 2step	SPHWAHDNG23YZT2DB	4193	171	
			MacAdam 3step	SPHWAHDNG23YZT3DB			
		5000	MacAdam 2step	SPHWAHDNG23YZR2DB	4194	171	
			MacAdam 3step	SPHWAHDNG23YZR3DB			
	2700	MacAdam 1step	SPHWAHDNG25YZW1DB	3616	148		
		MacAdam 2step	SPHWAHDNG25YZW2DB				
		MacAdam 3step	SPHWAHDNG25YZW3DB				
	3000	MacAdam 1step	SPHWAHDNG25YZV1DB	3762	154		
		MacAdam 2step	SPHWAHDNG25YZV2DB				
		MacAdam 3step	SPHWAHDNG25YZV3DB				
	3500	MacAdam 1step	SPHWAHDNG25YZU1DB	3872	158		
		MacAdam 2step	SPHWAHDNG25YZU2DB				
		MacAdam 3step	SPHWAHDNG25YZU3DB				
	80+	4000	MacAdam 1step	SPHWAHDNG25YZT1DB	3950	161	
			MacAdam 2step	SPHWAHDNG25YZT2DB			
			MacAdam 3step	SPHWAHDNG25YZT3DB			
		5000	MacAdam 2step	SPHWAHDNG25YZR2DB	3983	163	
			MacAdam 3step	SPHWAHDNG25YZR3DB			
			MacAdam 2step	SPHWAHDNG25YZQ2DB			
	MacAdam 3step	SPHWAHDNG25YZQ3DB					
	6500	MacAdam 2step	SPHWAHDNG25YZP2DB	3930	161		
		MacAdam 3step	SPHWAHDNG25YZP3DB				
MacAdam 1step		SPHWAHDNG27YZW1DB	3048			125	
2700	MacAdam 2step	SPHWAHDNG27YZW2DB					
	MacAdam 3step	SPHWAHDNG27YZW3DB					
	3000	MacAdam 1step	SPHWAHDNG27YZV1DB	3190	130		
MacAdam 2step		SPHWAHDNG27YZV2DB					
MacAdam 3step		SPHWAHDNG27YZV3DB					
90+	3500	MacAdam 1step	SPHWAHDNG27YZU1DB	3319	136		
		MacAdam 2step	SPHWAHDNG27YZU2DB				
		MacAdam 3step	SPHWAHDNG27YZU3DB				
	4000	MacAdam 1step	SPHWAHDNG27YZT1DB	3387	138		
		MacAdam 2step	SPHWAHDNG27YZT2DB				
		MacAdam 3step	SPHWAHDNG27YZT3DB				
5000	MacAdam 2step	SPHWAHDNG27YZR2DB	3433	140			
	MacAdam 3step	SPHWAHDNG27YZR3DB					

Chip-on-Board LEDs

Package

Product	CRI	CCT (K)	Color Rank	Part Number	T _j =85°C		I _F (mA) V _F (V)
					Luminous Flux Typ. (lm)	Luminous Efficacy Typ. (lm/W)	
LC033D Gen 2+	70+	3000	MacAdam 2step	SPHWAHDNH23YZV2DB	5014	164	900mA 34V
			MacAdam 3step	SPHWAHDNH23YZV3DB			
		4000	MacAdam 2step	SPHWAHDNH23YZT2DB	5175	169	
			MacAdam 3step	SPHWAHDNH23YZT3DB			
		5000	MacAdam 2step	SPHWAHDNH23YZR2DB	5202	170	
			MacAdam 3step	SPHWAHDNH23YZR3DB			
	2700	MacAdam 1step	SPHWAHDNH25YZW1DB	4462	146		
		MacAdam 2step	SPHWAHDNH25YZW2DB				
		MacAdam 3step	SPHWAHDNH25YZW3DB				
	3000	MacAdam 1step	SPHWAHDNH25YZV1DB	4643	152		
		MacAdam 2step	SPHWAHDNH25YZV2DB				
		MacAdam 3step	SPHWAHDNH25YZV3DB				
	80+	3500	MacAdam 1step	SPHWAHDNH25YZU1DB	4779	156	
			MacAdam 2step	SPHWAHDNH25YZU2DB			
			MacAdam 3step	SPHWAHDNH25YZU3DB			
		4000	MacAdam 1step	SPHWAHDNH25YZT1DB	4875	159	
			MacAdam 2step	SPHWAHDNH25YZT2DB			
			MacAdam 3step	SPHWAHDNH25YZT3DB			
5000	MacAdam 2step	SPHWAHDNH25YZR2DB	4916	161			
	MacAdam 3step	SPHWAHDNH25YZR3DB					
	MacAdam 2step	SPHWAHDNH25YZQ2DB			4891	160	
MacAdam 3step	SPHWAHDNH25YZQ3DB						
6500	MacAdam 2step	SPHWAHDNH25YZP2DB	4875	159			
	MacAdam 3step	SPHWAHDNH25YZP3DB					
	MacAdam 1step	SPHWAHDNH27YZW1DB			3781	124	
MacAdam 2step	SPHWAHDNH27YZW2DB						
MacAdam 3step	SPHWAHDNH27YZW3DB						
90+	3000	MacAdam 1step	SPHWAHDNH27YZV1DB	3977	130		
		MacAdam 2step	SPHWAHDNH27YZV2DB				
		MacAdam 3step	SPHWAHDNH27YZV3DB				
	3500	MacAdam 1step	SPHWAHDNH27YZU1DB	4096	134		
		MacAdam 2step	SPHWAHDNH27YZU2DB				
		MacAdam 3step	SPHWAHDNH27YZU3DB				
4000	MacAdam 1step	SPHWAHDNH27YZT1DB	4180	137			
	MacAdam 2step	SPHWAHDNH27YZT2DB					
	MacAdam 3step	SPHWAHDNH27YZT3DB					
5000	MacAdam 2step	SPHWAHDNH27YZR2DB	4237	138			
	MacAdam 3step	SPHWAHDNH27YZR3DB					



LC033D Gen 2+

Chip-on-Board LEDs

Package

Product	CRI	CCT (K)	Color Rank	Part Number	T _j =85°C		I _F (mA) V _F (V)
					Luminous Flux Typ. (lm)	Luminous Efficacy Typ. (lm/W)	
LC040D Gen 2+	70+	3000	MacAdam 2step	SPHWAHDNK23YZV2DB	6304	172	1080mA 34V
			MacAdam 3step	SPHWAHDNK23YZV3DB			
		4000	MacAdam 2step	SPHWAHDNK23YZT2DB	6506	177	
			MacAdam 3step	SPHWAHDNK23YZT3DB			
		5000	MacAdam 2step	SPHWAHDNK23YZR2DB	6474	176	
			MacAdam 3step	SPHWAHDNK23YZR3DB			
	2700	MacAdam 1step	SPHWAHDNK25YZW1DB	5575	152		
		MacAdam 2step	SPHWAHDNK25YZW2DB				
		MacAdam 3step	SPHWAHDNK25YZW3DB				
	3000	MacAdam 1step	SPHWAHDNK25YZV1DB	5837	159		
		MacAdam 2step	SPHWAHDNK25YZV2DB				
		MacAdam 3step	SPHWAHDNK25YZV3DB				
	80+	3500	MacAdam 1step	SPHWAHDNK25YZU1DB	5925	161	
			MacAdam 2step	SPHWAHDNK25YZU2DB			
			MacAdam 3step	SPHWAHDNK25YZU3DB			
		4000	MacAdam 1step	SPHWAHDNK25YZT1DB	6084	166	
			MacAdam 2step	SPHWAHDNK25YZT2DB			
			MacAdam 3step	SPHWAHDNK25YZT3DB			
5000	MacAdam 2step	SPHWAHDNK25YZR2DB	6113	166			
	MacAdam 3step	SPHWAHDNK25YZR3DB					
	MacAdam 2step	SPHWAHDNK25YZQ2DB			6081	166	
MacAdam 3step	SPHWAHDNK25YZQ3DB						
6500	MacAdam 2step	SPHWAHDNK25YZP2DB	6015	164			
	MacAdam 3step	SPHWAHDNK25YZP3DB					
	MacAdam 1step	SPHWAHDNK27YZW1DB			4660	127	
MacAdam 2step	SPHWAHDNK27YZW2DB						
MacAdam 3step	SPHWAHDNK27YZW3DB						
90+	3000	MacAdam 1step	SPHWAHDNK27YZV1DB	4923	134		
		MacAdam 2step	SPHWAHDNK27YZV2DB				
		MacAdam 3step	SPHWAHDNK27YZV3DB				
	3500	MacAdam 1step	SPHWAHDNK27YZU1DB	5100	139		
		MacAdam 2step	SPHWAHDNK27YZU2DB				
		MacAdam 3step	SPHWAHDNK27YZU3DB				
4000	MacAdam 1step	SPHWAHDNK27YZT1DB	5213	142			
	MacAdam 2step	SPHWAHDNK27YZT2DB					
	MacAdam 3step	SPHWAHDNK27YZT3DB					
5000	MacAdam 2step	SPHWAHDNK27YZR2DB	5325	145			
	MacAdam 3step	SPHWAHDNK27YZR3DB					



LC040D Gen 2+

Chip-on-Board LEDs

Package

Product	CRI	CCT (K)	Color Rank	Part Number	T _j =85°C		I _F (mA) V _F (V)
					Luminous Flux Typ. (lm)	Luminous Efficacy Typ. (lm/W)	
LC060D Gen 2+	70+	3000	MacAdam 2step	SPHWAHDNL231ZV2DB	9225	167	1080mA 51.1V
			MacAdam 3step	SPHWAHDNL231ZV3DB			
		4000	MacAdam 2step	SPHWAHDNL231ZT2DBB	9521	173	
			MacAdam 3step	SPHWAHDNL231ZT3DB			
		5000	MacAdam 2step	SPHWAHDNL231ZR2DB	9475	172	
			MacAdam 3step	SPHWAHDNL231ZR3DB			
	2700	MacAdam 1step	SPHWAHDNL251ZW1DB	8148	148		
		MacAdam 2step	SPHWAHDNL251ZW2DB				
		MacAdam 3step	SPHWAHDNL251ZW3DB				
	3000	MacAdam 1step	SPHWAHDNL251ZV1DB	8499	154		
		MacAdam 2step	SPHWAHDNL251ZV2DB				
		MacAdam 3step	SPHWAHDNL251ZV3DB				
80+	3500	MacAdam 1step	SPHWAHDNL251ZU1DB	8680	157		
		MacAdam 2step	SPHWAHDNL251ZU2DB				
		MacAdam 3step	SPHWAHDNL251ZU3DB				
	4000	MacAdam 1step	SPHWAHDNL251ZT1DB	8905	161		
		MacAdam 2step	SPHWAHDNL251ZT2DB				
		MacAdam 3step	SPHWAHDNL251ZT3DB				
5000	MacAdam 2step	SPHWAHDNL251ZR2DB	8949	162			
	MacAdam 3step	SPHWAHDNL251ZR3DB					
	MacAdam 2step	SPHWAHDNL251ZQ2DB			8902	161	
MacAdam 3step	SPHWAHDNL251ZQ3DB						
6500	MacAdam 2step	SPHWAHDNL251ZP2DB	8855	160			
	MacAdam 3step	SPHWAHDNL251ZP3DB					
	MacAdam 1step	SPHWAHDNL271ZW1DB			6854	124	
2700	MacAdam 2step	SPHWAHDNL271ZW2DB					
	MacAdam 3step	SPHWAHDNL271ZW3DB					
	3000	MacAdam 1step	SPHWAHDNL271ZV1DB	7205	131		
MacAdam 2step		SPHWAHDNL271ZV2DB					
MacAdam 3step		SPHWAHDNL271ZV3DB					
90+	3500	MacAdam 1step	SPHWAHDNL271ZU1DB	7539	137		
		MacAdam 2step	SPHWAHDNL271ZU2DB				
		MacAdam 3step	SPHWAHDNL271ZU3DB				
	4000	MacAdam 1step	SPHWAHDNL271ZT1DB	7629	138		
		MacAdam 2step	SPHWAHDNL271ZT2DB				
		MacAdam 3step	SPHWAHDNL271ZT3DB				
5000	MacAdam 2step	SPHWAHDNL271ZR2DB	7793	141			
	MacAdam 3step	SPHWAHDNL271ZR3DB					



Chip-on-Board LEDs

Package



Product	CRI	CCT (K)	Color Rank	Part Number	T _j =85°C		I _F (mA) V _F (V)
					Luminous Flux Typ. (lm)	Luminous Efficacy Typ. (lm/W)	
LC080D Gen 2+	70+	3000	MacAdam 2step	SPHWAHDNM231ZV2DB	13465	163	1620mA 51.1V
			MacAdam 3step	SPHWAHDNM231ZV3DB			
		4000	MacAdam 2step	SPHWAHDNM231ZT2DB	13966	169	
			MacAdam 3step	SPHWAHDNM231ZT3DB			
		5000	MacAdam 2step	SPHWAHDNM231ZR2DB	14041	170	
			MacAdam 3step	SPHWAHDNM231ZR3DB			
	2700	MacAdam 1step	SPHWAHDNM251ZW1DB	12051	146		
		MacAdam 2step	SPHWAHDNM251ZW2DB				
		MacAdam 3step	SPHWAHDNM251ZW3DB				
	3000	MacAdam 1step	SPHWAHDNM251ZV1DB	12468	151		
		MacAdam 2step	SPHWAHDNM251ZV2DB				
		MacAdam 3step	SPHWAHDNM251ZV3DB				
80+	3500	MacAdam 1step	SPHWAHDNM251ZU1DB	12852	155		
		MacAdam 2step	SPHWAHDNM251ZU2DB				
		MacAdam 3step	SPHWAHDNM251ZU3DB				
	4000	MacAdam 1step	SPHWAHDNM251ZT1DB	13123	159		
		MacAdam 2step	SPHWAHDNM251ZT2DB				
		MacAdam 3step	SPHWAHDNM251ZT3DB				
5000	MacAdam 2step	SPHWAHDNM251ZR2DB	13196	159			
	MacAdam 3step	SPHWAHDNM251ZR3DB					
	MacAdam 2step	SPHWAHDNM251ZQ2DB			13126	159	
MacAdam 3step	SPHWAHDNM251ZQ3DB						
6500	MacAdam 2step	SPHWAHDNM251ZP2DB	13121	159			
	MacAdam 3step	SPHWAHDNM251ZP3DB					
	MacAdam 1step	SPHWAHDNM271ZW1DB			10157	123	
2700	MacAdam 2step	SPHWAHDNM271ZW2DB					
	MacAdam 3step	SPHWAHDNM271ZW3DB					
	3000	MacAdam 1step	SPHWAHDNM271ZV1DB	10678	129		
MacAdam 2step		SPHWAHDNM271ZV2DB					
MacAdam 3step		SPHWAHDNM271ZV3DB					
90+	3500	MacAdam 1step	SPHWAHDNM271ZU1DB	11004	133		
		MacAdam 2step	SPHWAHDNM271ZU2DB				
		MacAdam 3step	SPHWAHDNM271ZU3DB				
	4000	MacAdam 1step	SPHWAHDNM271ZT1DB	11247	136		
		MacAdam 2step	SPHWAHDNM271ZT2DB				
		MacAdam 3step	SPHWAHDNM271ZT3DB				
5000	MacAdam 2step	SPHWAHDNM271ZR2DB	11432	138			
	MacAdam 3step	SPHWAHDNM271ZR3DB					



R-series Fashion

R-series Fashion spectrum pursues high contrast for retail shop

- Fashion Vivid Color: highlight all RGB colors
- Fashion Vivid White: below BBL, clear white

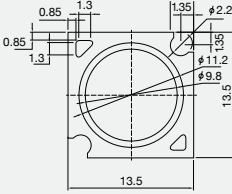
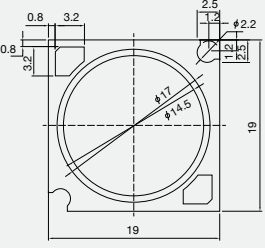
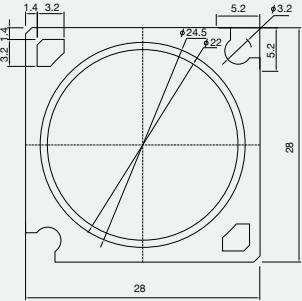
T _J =85°C	LC013R Fashion	LC016R Fashion	LC019R Fashion	LC026R Fashion	LC033R Fashion	LC040R Fashion
						
LES	9.8mm	14.5mm			22mm	
Typical	12.5W	15.6W	18.7W	24.9W	31.1W	37.4W
	360mA	450mA	540mA	720mA	900mA	1080mA
Max.	34.5W	43.1W	51.8W	69.0W	86.2W	103.5W
	920mA	1150mA	1380mA	1840mA	2300mA	2760mA
Dimension						
Size	13.5mm x 13.5mm	19mm x 19mm			28mm x 28mm	

Vivid White (in Gen 2)

Product	CRI Min.	CCT(K)	Color Rank	Part Number	T _J =85°C		I _F (mA) V _F (V)
					Luminous Flux Typ. (lm)	Luminous Efficacy Typ. (lm/W)	
 LC013R Fashion Vivid White	90+	3000 (Below BBL)	MacAdam 3step	SPHWAHDND27YZVND2	1435	115	360mA 34.6V
		3500 (Below BBL)	MacAdam 3step	SPHWAHDND27YZUND2	1494	120	
		4000 (Below BBL)	MacAdam 3step	SPHWAHDND27YZTND2	1541	124	
 LC016R Fashion Vivid White	90+	3000 (Below BBL)	MacAdam 3step	SPHWAHDNE27YZVND2	1837	118	450mA 34.6V
		3500 (Below BBL)	MacAdam 3step	SPHWAHDNE27YZUND2	1912	123	
		4000 (Below BBL)	MacAdam 3step	SPHWAHDNE27YZTND2	1972	127	
 LC019R Fashion Vivid White	90+	3000 (Below BBL)	MacAdam 3step	SPHWAHDNF27YZVND2	2195	117	540mA 34.6V
		3500 (Below BBL)	MacAdam 3step	SPHWAHDNF27YZUND2	2284	122	
		4000 (Below BBL)	MacAdam 3step	SPHWAHDNF27YZTND2	2355	126	
 LC026R Fashion Vivid White	90+	3000 (Below BBL)	MacAdam 3step	SPHWAHDNG27YZVND2	2917	117	720mA 34.6V
		3500 (Below BBL)	MacAdam 3step	SPHWAHDNG27YZUND2	3036	122	
		4000 (Below BBL)	MacAdam 3step	SPHWAHDNG27YZTND2	3131	126	
 LC033R Fashion Vivid White	90+	3000 (Below BBL)	MacAdam 3step	SPHWAHDNH27YZVND2	3589	115	900mA 34.6V
		3500 (Below BBL)	MacAdam 3step	SPHWAHDNH27YZUND2	3735	120	
		4000 (Below BBL)	MacAdam 3step	SPHWAHDNH27YZTND2	3852	124	
 LC040R Fashion Vivid White	90+	3000 (Below BBL)	MacAdam 3step	SPHWAHDNK27YZVND2	4428	118	1080mA 34.6V
		3500 (Below BBL)	MacAdam 3step	SPHWAHDNK27YZUND2	4591	123	
		4000 (Below BBL)	MacAdam 3step	SPHWAHDNK27YZTND2	4745	127	



Vivid White (in Gen 2+)



Product	CRI Min.	CCT(K)	Color Rank	Part Number	T _j =85°C		I _F (mA) V _F (V)
					Luminous Flux Typ. (lm)	Luminous Efficacy Typ. (lm/W)	
 LC013R Fashion Vivid White	90+	3000 (Below BBL)	MacAdam 3step	SPHWAHDND27YZVNDB	1511	123	360mA 34V
		3500 (Below BBL)	MacAdam 3step	SPHWAHDND27YZUNDB	1526	125	
		4000 (Below BBL)	MacAdam 3step	SPHWAHDND27YTNDB	1622	133	
 LC016R Fashion Vivid White	90+	3000 (Below BBL)	MacAdam 3step	SPHWAHDNE27YZVNDB	1934	126	450mA 34V
		3500 (Below BBL)	MacAdam 3step	SPHWAHDNE27YZUNDB	1953	128	
		4000 (Below BBL)	MacAdam 3step	SPHWAHDNE27YTNDB	2078	136	
 LC019R Fashion Vivid White	90+	3000 (Below BBL)	MacAdam 3step	SPHWAHDNF27YZVNDB	2310	126	540mA 34V
		3500 (Below BBL)	MacAdam 3step	SPHWAHDNF27YZUNDB	2333	127	
		4000 (Below BBL)	MacAdam 3step	SPHWAHDNF27YTNDB	2479	135	
 LC026R Fashion Vivid White	90+	3000 (Below BBL)	MacAdam 3step	SPHWAHDNG27YZVNDB	3071	125	720mA 34V
		3500 (Below BBL)	MacAdam 3step	SPHWAHDNG27YZUNDB	3102	127	
		4000 (Below BBL)	MacAdam 3step	SPHWAHDNG27YTNDB	3296	135	
 LC033R Fashion Vivid White"	90+	3000 (Below BBL)	MacAdam 3step	SPHWAHDNH27YZVNDB	3778	123	900mA 34V
		3500 (Below BBL)	MacAdam 3step	SPHWAHDNH27YZUNDB	3816	125	
		4000 (Below BBL)	MacAdam 3step	SPHWAHDNH27YTNDB	4055	133	
 LC040R Fashion Vivid White	90+	3000 (Below BBL)	MacAdam 3step	SPHWAHDNK27YZVNDB	4590	125	1080mA 34V
		3500 (Below BBL)	MacAdam 3step	SPHWAHDNK27YZUNDB	4536	124	
		4000 (Below BBL)	MacAdam 3step	SPHWAHDNK27YTNDB	4926	134	

Vivid White (in Gen 3+)

Product	CRI Min.	CCT(K)	Color Rank	Part Number	T _j =85°C		I _F (mA) V _F (V)
					Luminous Flux Typ. (lm)	Luminous Efficacy Typ. (lm/W)	
 LC013R Fashion Vivid White	90+	3000 (Below BBL)	MacAdam 3step	SPHWAHDND27YZVNDC	1541	127	360mA 33.7V
		3500 (Below BBL)	MacAdam 3step	SPHWAHDND27YZUNDC	1557	128	
		4000 (Below BBL)	MacAdam 3step	SPHWAHDND27YTNDC	1654	136	
 LC016R Fashion Vivid White	90+	3000 (Below BBL)	MacAdam 3step	SPHWAHDNE27YZVNDC	1973	130	450mA 33.7V
		3500 (Below BBL)	MacAdam 3step	SPHWAHDNE27YZUNDC	1992	131	
		4000 (Below BBL)	MacAdam 3step	SPHWAHDNE27YTNDC	2117	140	
 LC019R Fashion Vivid White	90+	3000 (Below BBL)	MacAdam 3step	SPHWAHDNF27YZVNDC	2356	129	540mA 33.7V
		3500 (Below BBL)	MacAdam 3step	SPHWAHDNF27YZUNDC	2380	131	
		4000 (Below BBL)	MacAdam 3step	SPHWAHDNF27YTNDC	2529	139	
 LC026R Fashion Vivid White	90+	3000 (Below BBL)	MacAdam 3step	SPHWAHDNG27YZVNDC	3132	129	720mA 33.7V
		3500 (Below BBL)	MacAdam 3step	SPHWAHDNG27YZUNDC	3164	130	
		4000 (Below BBL)	MacAdam 3step	SPHWAHDNG27YTNDC	3362	139	
 LC033R Fashion Vivid White"	90+	3000 (Below BBL)	MacAdam 3step	SPHWAHDNH27YZVNDC	3800	125	900mA 33.7V
		3500 (Below BBL)	MacAdam 3step	SPHWAHDNH27YZUNDC	3838	127	
		4000 (Below BBL)	MacAdam 3step	SPHWAHDNH27YTNDC	4078	134	
 LC040R Fashion Vivid White	90+	3000 (Below BBL)	MacAdam 3step	SPHWAHDNK27YZVNDC	4755	131	1080mA 33.7V
		3500 (Below BBL)	MacAdam 3step	SPHWAHDNK27YZUNDC	4803	132	
		4000 (Below BBL)	MacAdam 3step	SPHWAHDNK27YTNDC	5103	140	

Vivid Color



Product	CCT(K)	Color Rank	Part Number	T _j =85°C		I _F (mA) V _F (V)
				Luminous Flux Typ. (lm)	Luminous Efficacy Typ. (lm/W)	
 LC013R Fashion Vivid Color	3000 (Below BBL)	MacAdam 2step	SPHWWAHDND2VYZV2D2	1334	107	360mA 34.6V
		MacAdam 3step	SPHWWAHDND2VYZVVD2			
	3300 (Below BBL)	MacAdam 2step	SPHWWAHDND2VYZA2D2	1394	112	
		MacAdam 3step	SPHWWAHDND2VYZAVD2			
	3500 (Below BBL)	MacAdam 2step	SPHWWAHDND2VYZU2D2	1433	115	
		MacAdam 3step	SPHWWAHDND2VYZUVD2			
4000 (Below BBL)	MacAdam 2step	SPHWWAHDND2VYZT2D2	1533	123		
	MacAdam 3step	SPHWWAHDND2VYZTVD2				
 LC016R Fashion Vivid Color	3000 (Below BBL)	MacAdam 2step	SPHWWAHDNE2VYZV2D2	1745	112	450mA 34.6V
		MacAdam 3step	SPHWWAHDNE2VYZVVD2			
	3300 (Below BBL)	MacAdam 2step	SPHWWAHDNE2VYZA2D2	1823	117	
		MacAdam 3step	SPHWWAHDNE2VYZAVD2			
	3500 (Below BBL)	MacAdam 2step	SPHWWAHDNE2VYZU2D2	1875	120	
		MacAdam 3step	SPHWWAHDNE2VYZUVD2			
4000 (Below BBL)	MacAdam 2step	SPHWWAHDNE2VYZT2D2	2005	129		
	MacAdam 3step	SPHWWAHDNE2VYZTVD2				
 LC019R Fashion Vivid Color	3000 (Below BBL)	MacAdam 2step	SPHWWAHDNF2VYZV2D2	2068	111	540mA 34.6V
		MacAdam 3step	SPHWWAHDNF2VYZVVD2			
	3300 (Below BBL)	MacAdam 2step	SPHWWAHDNF2VYZA2D2	2160	116	
		MacAdam 3step	SPHWWAHDNF2VYZAVD2			
	3500 (Below BBL)	MacAdam 2step	SPHWWAHDNF2VYZU2D2	2222	119	
		MacAdam 3step	SPHWWAHDNF2VYZUVD2			
4000 (Below BBL)	MacAdam 2step	SPHWWAHDNF2VYZT2D2	2376	127		
	MacAdam 3step	SPHWWAHDNF2VYZTVD2				

Product	CCT(K)	Color Rank	Part Number	T _j =85°C		I _F (mA) V _F (V)
				Luminous Flux Typ. (lm)	Luminous Efficacy Typ. (lm/W)	
 LC026R Fashion Vivid Color	3000 (Below BBL)	MacAdam 2step	SPHWWAHDNG2VYZV2D2	2706	109	720mA 34.6V
		MacAdam 3step	SPHWWAHDNG2VYZVVD2			
	3300 (Below BBL)	MacAdam 2step	SPHWWAHDNG2VYZA2D2	2827	113	
		MacAdam 3step	SPHWWAHDNG2VYZAVD2			
	3500 (Below BBL)	MacAdam 2step	SPHWWAHDNG2VYZU2D2	2907	117	
		MacAdam 3step	SPHWWAHDNG2VYZUVD2			
4000 (Below BBL)	MacAdam 2step	SPHWWAHDNG2VYZT2D2	3108	125		
	MacAdam 3step	SPHWWAHDNG2VYZTVD2				
 LC033R Fashion Vivid Color	3000 (Below BBL)	MacAdam 2step	SPHWWAHDNH2VYZV2D2	3339	107	900mA 34.6V
		MacAdam 3step	SPHWWAHDNH2VYZVVD2			
	3300 (Below BBL)	MacAdam 2step	SPHWWAHDNH2VYZA2D2	3488	112	
		MacAdam 3step	SPHWWAHDNH2VYZAVD2			
	3500 (Below BBL)	MacAdam 2step	SPHWWAHDNH2VYZU2D2	3588	115	
		MacAdam 3step	SPHWWAHDNH2VYZUVD2			
4000 (Below BBL)	MacAdam 2step	SPHWWAHDNH2VYZT2D2	3836	123		
	MacAdam 3step	SPHWWAHDNH2VYZTVD2				
 LC040R Fashion Vivid Color	3000 (Below BBL)	MacAdam 2step	SPHWWAHDNK2VYZV2D2	4150	111	1080mA 34.6V
		MacAdam 3step	SPHWWAHDNK2VYZVVD2			
	3300 (Below BBL)	MacAdam 2step	SPHWWAHDNK2VYZA2D2	4335	116	
		MacAdam 3step	SPHWWAHDNK2VYZAVD2			
	3500 (Below BBL)	MacAdam 2step	SPHWWAHDNK2VYZU2D2	4459	119	
		MacAdam 3step	SPHWWAHDNK2VYZUVD2			
4000 (Below BBL)	MacAdam 2step	SPHWWAHDNK2VYZT2D2	4768	128		
	MacAdam 3step	SPHWWAHDNK2VYZTVD2				

R-series Meat

Special spectrum enhanced vividness for Meat

- Red saturated color, Fresh(Red), Delicious(Red), Vividness

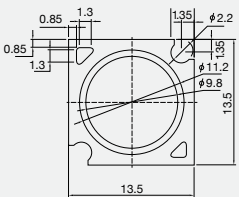
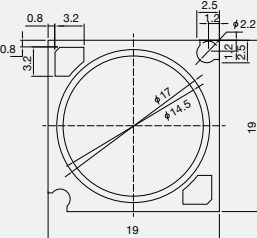
T _j =85°C	LC013R Meat	LC016R Meat	LC019R Meat	LC026R Meat	LC033R Meat
LES					
	9.8mm	14.5mm			
Typical	12.5W	15.6W	18.7W	24.9W	31.1W
	360mA	450mA	540mA	720mA	900mA
Max.	34.5W	43.1W	51.8W	69.0W	86.2W
	920mA	1150mA	1380mA	1840mA	2300mA
Dimension					
Size	13.5mm x 13.5mm	19mm x 19mm			

Product	Color Rank	Part Number	T _j =85°C		I _F (mA) V _F (V)
			Luminous Flux Typ. (lm)	Luminous Efficacy Typ. (lm/W)	
 LC013R Meat	MacAdam 2step	SPHWAHDND2VYZTSD2	914	73	360mA 34.6V
 LC016R Meat	MacAdam 2step	SPHWAHDNE2VYZTSD2	1188	76	450mA 34.6V
 LC019R Meat	MacAdam 2step	SPHWAHDNF2VYZTSD2	1412	76	540mA 34.6V
 LC026R Meat	MacAdam 2step	SPHWAHDNG2VYZTSD2	1845	74	720mA 34.6V
 LC033R Meat	MacAdam 2step	SPHWAHDNH2VYZTSD2	2284	73	900mA 34.6V

R-series Vegetable

Special spectrum enhanced vividness for Vegetable

- Green & Red saturated color, Fresh, Delicious, Vividness

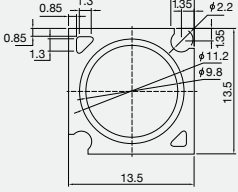
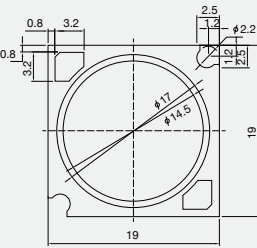
T _j =85°C	LC013R Vegetable	LC016R Vegetable	LC019R Vegetable	LC026R Vegetable	LC033R Vegetable
LES	9.8mm	14.5mm			
Typical	12.5W	15.6W	18.7W	24.9W	31.1W
	360mA	450mA	540mA	720mA	900mA
Max.	34.5W	43.1W	51.8W	69.0W	86.2W
	920mA	1150mA	1380mA	1840mA	2300mA
Dimension					
Size	13.5mm x 13.5mm	19mm x 19mm			

Product	Color Rank	Part Number	T _j =85°C		I _F (mA) V _F (V)
			Luminous Flux Typ. (lm)	Luminous Efficacy Typ. (lm/W)	
 LC013R Vegetable	MacAdam 2step	SPHWAHDND2VYZRSD2	1188	95	360mA 34.6V
 LC016R Vegetable	MacAdam 2step	SPHWAHDNE2VYZRSD2	1544	99	450mA 34.6V
 LC019R Vegetable	MacAdam 2step	SPHWAHDNF2VYZRSD2	1835	98	540mA 34.6V
 LC026R Vegetable	MacAdam 2step	SPHWAHDNG2VYZRSD2	2399	96	720mA 34.6V
 LC033R Vegetable	MacAdam 2step	SPHWAHDNH2VYZRSD2	2969	95	900mA 34.6V

T-series

Wide CCT tuning (2700K~6500K) through 2-channel (warm & cool white) current driving

- High efficacy for Tunable COB (140lm/W @CRI80, 6500K)
- Excellent color uniformity with concentric chip arrangement



T _J =85°C	LC010T	LC020T	LC035T
LES	9.8mm	13mm	22mm
Typical	9.8W	19.6W	34.3W
	280mA	560mA	980mA
Max.	15W	30W	45W
	400mA	800mA	1250mA
Dimension			
Size	19mm x 19mm		28mm x 28mm





Product	CRI	CCT (K)	Color Rank	Part Number	T _J =85°C		I _F (mA)	V _F (V)			
					Luminous Flux Typ. (lm)	Luminous Efficacy Typ. (lm/W)					
	80+	2700	MacAdam 3step	SPHWAHDNC25YZWPT1	1190	120	280mA	35.0V			
		6500	MacAdam 5step		1352	136					
	90+	2700	MacAdam 3step	SPHWAHDNC27YZWPT1	988	99					
		5000	MacAdam 5step		1149	116					
		80+	2700	MacAdam 3step	SPHWAHDNF25YZWPT1	2355			118	560mA	35.0V
			6500	MacAdam 5step		2676			135		
90+		2700	MacAdam 3step	SPHWAHDNF27YZWPT1	1956	98					
		5000	MacAdam 5step		2275	114					
		80+	2700	MacAdam 3step	SPHWAHDNH25YZWPT1	4405	127	980mA	35.0V		
			6500	MacAdam 5step		5006	144				
	90+	2700	MacAdam 3step	SPHWAHDNH27YZWPT1	3660	105					
		5000	MacAdam 5step		4255	122					

C Series Gen 2 [Small LES COB]

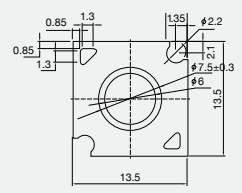
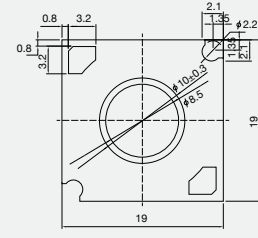
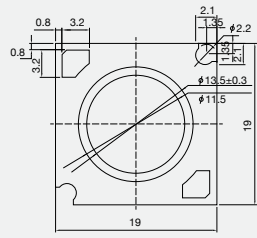
Suitable for narrow beam spot lights and downlights

- Uses new flip-chip technology
- Low droop to improve current and thermal performance
- High reliability
- Completed 6,000 hours of LM-80 testing

T _j =85°C	LC010C Gen 2	LC020C Gen 2	LC030C Gen 2	LC040C Gen 2
				
LES	6.0mm	8.5mm	11.5mm	
Typical	10.5W (300mA)	21.0W (600mA)	31.5W (900mA)	36.8W (1050mA)
Max.	13.8W (380mA)	34.0W (920mA)	51.1W (1380mA)	59.5W (1610mA)
Dimension				
Size	13.5mm x 13.5mm	19mm x 19mm	19mm x 19mm	

Product	CRI	CCT (K)	Color rank	Part Number	T _j =85°C		I _F (mA) V _F (V)
					Luminous Flux Typ. (lm)	Luminous Efficacy Typ. (lm/W)	
 LC010C Gen 2	80+	2700	MacAdam 3step	SPHWAHDNC25YZW3C2	1212	115	300mA 35.0V
		3000	MacAdam 3step	SPHWAHDNC25YZV3C2	1274	121	
		3500	MacAdam 3step	SPHWAHDNC25YZU3C2	1311	125	
		4000	MacAdam 3step	SPHWAHDNC25YZT3C2	1337	127	
		5000	MacAdam 3step	SPHWAHDNC25YZR3C2	1348	128	
	90+	2700	MacAdam 3step	SPHWAHDNC27YZW3C2	1037	99	
		3000	MacAdam 3step	SPHWAHDNC27YZV3C2	1091	104	
		3500	MacAdam 3step	SPHWAHDNC27YZU3C2	1123	107	
		4000	MacAdam 3step	SPHWAHDNC27YZT3C2	1147	109	
		5000	MacAdam 3step	SPHWAHDNC27YZR3C2	1156	110	
 LC020C Gen 2	80+	2700	MacAdam 3step	SPHWAHDNF25YZW3C2	2485	118	600mA 35.0V
		3000	MacAdam 3step	SPHWAHDNF25YZV3C2	2625	125	
		3500	MacAdam 3step	SPHWAHDNF25YZU3C2	2688	128	
		4000	MacAdam 3step	SPHWAHDNF25YZT3C2	2742	131	
		5000	MacAdam 3step	SPHWAHDNF25YZR3C2	2765	132	
	90+	2700	MacAdam 3step	SPHWAHDNF27YZW3C2	2127	101	
		3000	MacAdam 3step	SPHWAHDNF27YZV3C2	2237	107	
		3500	MacAdam 3step	SPHWAHDNF27YZU3C2	2304	110	
		4000	MacAdam 3step	SPHWAHDNF27YZT3C2	2351	112	
		5000	MacAdam 3step	SPHWAHDNF27YZR3C2	2372	113	
 LC030C Gen 2	80+	2700	MacAdam 3step	SPHWAHDNH25YZW3C2	3765	120	900mA 35.0V
		3000	MacAdam 3step	SPHWAHDNH25YZV3C2	3956	126	
		3500	MacAdam 3step	SPHWAHDNH25YZU3C2	4072	129	
		4000	MacAdam 3step	SPHWAHDNH25YZT3C2	4154	132	
		5000	MacAdam 3step	SPHWAHDNH25YZR3C2	4188	133	
	90+	2700	MacAdam 3step	SPHWAHDNH27YZW3C2	3222	102	
		3000	MacAdam 3step	SPHWAHDNH27YZV3C2	3389	108	
		3500	MacAdam 3step	SPHWAHDNH27YZU3C2	3490	111	
		4000	MacAdam 3step	SPHWAHDNH27YZT3C2	3562	113	
		5000	MacAdam 3step	SPHWAHDNH27YZR3C2	3592	114	
 LC040C Gen 2	80+	2700	MacAdam 3step	SPHWAHDNK25YZW3C2	4305	117	1050mA 35.0V
		3000	MacAdam 3step	SPHWAHDNK25YZV3C2	4524	123	
		3500	MacAdam 3step	SPHWAHDNK25YZU3C2	4657	127	
		4000	MacAdam 3step	SPHWAHDNK25YZT3C2	4750	129	
		5000	MacAdam 3step	SPHWAHDNK25YZR3C2	4790	130	
	90+	2700	MacAdam 3step	SPHWAHDNK27YZW3C2	3684	100	
		3000	MacAdam 3step	SPHWAHDNK27YZV3C2	3875	105	
		3500	MacAdam 3step	SPHWAHDNK27YZU3C2	3991	109	
		4000	MacAdam 3step	SPHWAHDNK27YZT3C2	4073	111	
		5000	MacAdam 3step	SPHWAHDNK27YZR3C2	4108	112	

Module

Samsung LED

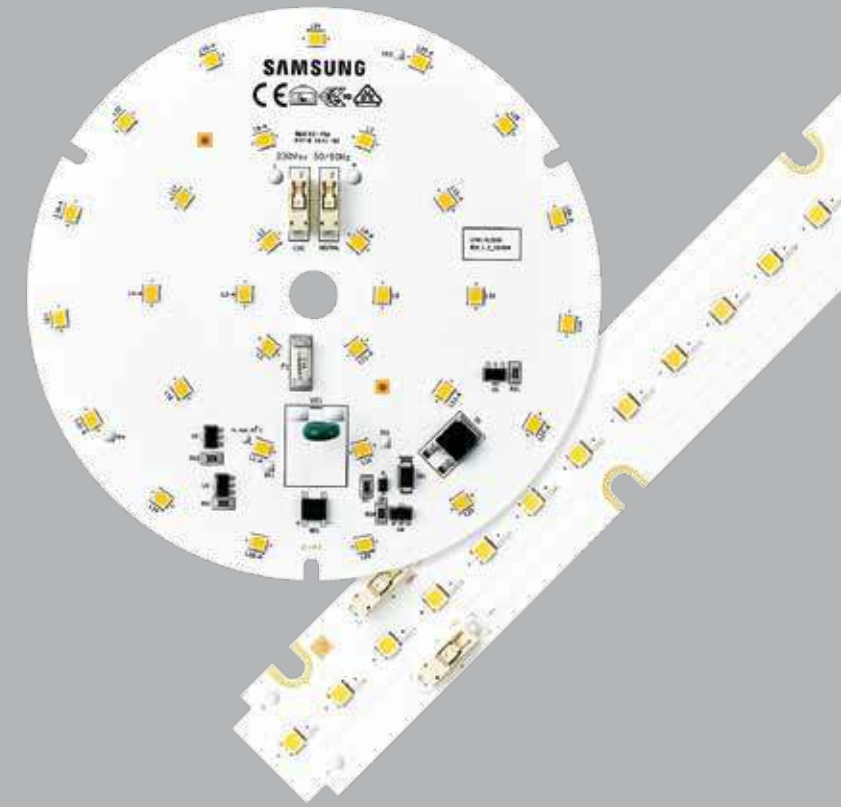
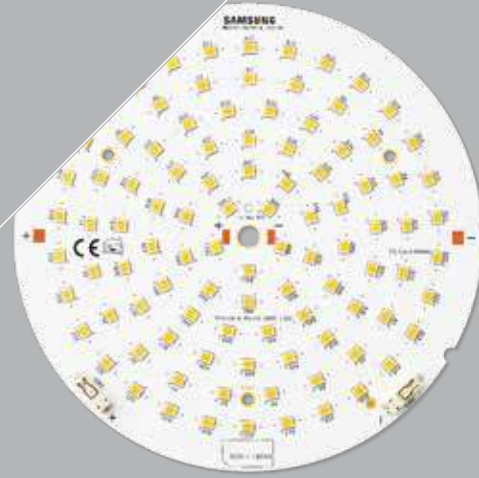

Ambient Light

Industrial Light

Down Light





Outdoor Light





With their modular construction, easy-to-use connections and optimal color consistency, Samsung's linear module line-ups are well-suited for a wide variety of luminaires.

- Tight color binning for best color consistency and high uniformity
- Modular design flexibility makes a wide variety of luminaire designs possible
- Peace of mind with Samsung-backed quality and performance

Product	Key Features	Efficacy (lm/W)	Lifespan
 Q-series	<ul style="list-style-type: none"> • Highest performance • 208lm/W [4000K, CRI 80+, Tp 40°C] • Lifetime: 50,000 hours, Beam angle: 115° 	●●●●●	●●●●●
 H-series	<ul style="list-style-type: none"> • High performance • 192lm/W [4000K, CRI 80+, Tp 40°C] • Lifetime: 50,000 hours, Beam angle: 115° 	●●●●○	●●●●○
 S-series	<ul style="list-style-type: none"> • High voltage solution • 180lm/W [4000K, CRI 80+, Tp 50°C] • Lifetime: 50,000 hours, Beam angle: 115° 	●●●○●	●●●○●
 V-series	<ul style="list-style-type: none"> • Value solution • 173lm/W [4000K, CRI 80+, Tp 50°C] • Lifetime: 50,000 hours, Beam angle: 115° 	●●●○●	●●●○●
 T-series	<ul style="list-style-type: none"> • White tunable solution with color temperatures from 2700K to 6500K • Lifetime: 50,000 hours, Beam angle: 115° 	●●○○○	●●○○○

Linear Module (Q-series)



LM 18x1120mm 4000lm (LT-QB22A)



LM 18x560mm 2000lm (LT-Q562A)



LM 18x280mm 1000lm (LT-Q282A)

Product	Luminous Flux (lm)	Power Consumption (W)	Input Voltage (V)	IF (mA)	Imax (mA)	Efficacy (lm/W)	CRI	CCT (K)	Size (mm)	Temperature Range (°C)	Certification	Model Name
LM 18x1120mm 4000lm 830 80LED G1 (LT-QB22A)	3680	19.7	43.8	450	900	187	80+	3000	1120x18x5.2	-20~+50	cUL, UL	SI-B8V201B20US
LM 18x1120mm 4000lm 835 80LED G1 (LT-QB22A)	3900					198		3500				SI-B8U201B20US
LM 18x1120mm 4000lm 840 80LED G1 (LT-QB22A)	4100					208		4000				SI-B8T201B20US
LM 18x1120mm 4000lm 850 80LED G1 (LT-QB22A)	4100					208		5000				SI-B8R201B20US
LM 18x560mm 2000lm 830 40LED G1 (LT-Q562A)	1840	9.9	21.9	450	900	187	80+	3000	560x18x5.8	-20~+50	cUL, UL	SI-B8V101560US
LM 18x560mm 2000lm 835 40LED G1 (LT-Q562A)	1950					198		3500				SI-B8U101560US
LM 18x560mm 2000lm 840 40LED G1 (LT-Q562A)	2050					208		4000				SI-B8T101560US
LM 18x560mm 2000lm 850 40LED G1 (LT-Q562A)	2050					208		5000				SI-B8R101560US
LM 18x280mm 1000lm 830 20LED G1 (LT-Q282A)	920	4.9	10.9	450	900	187	80+	3000	275x18x5.8	-20~+50	cUL, UL	SI-B8V051280US
LM 18x280mm 1000lm 835 20LED G1 (LT-Q282A)	975					198		3500				SI-B8U051280US
LM 18x280mm 1000lm 840 20LED G1 (LT-Q282A)	1025					208		4000				SI-B8T051280US
LM 18x280mm 1000lm 850 20LED G1 (LT-Q282A)	1025					208		5000				SI-B8R051280US



LM 24x560mm 2000lm (LT-Q562B)



LM 24x280mm 1000lm (LT-Q282B)

Product	Luminous Flux (lm)	Power Consumption (W)	Input Voltage (V)	IF (mA)	Imax (mA)	Efficacy (lm/W)	CRI	CCT (K)	Size (mm)	Temperature Range (°C)	Certification	Model Name
LM 24x560mm 2000lm 830 40LED G1 (LT-Q562B)	1840	9.9	54.8	180	360	187	80+	3000	560x24x5.2	-20~+50	CE, ENEC	SI-B8V103560EU
LM 24x560mm 2000lm 840 40LED G1 (LT-Q562B)	2000					203		4000				SI-B8T103560EU
LM 24x560mm 2000lm 865 40LED G1 (LT-Q562B)	2000					203		6500				SI-B8P103560EU
LM 24x280mm 1000lm 830 20LED G1 (LT-Q282B)	920	4.9	27.4	180	360	187	80+	3000	280x24x5.2	-20~+50	CE, ENEC	SI-B8V053280EU
LM 24x280mm 1000lm 840 20LED G1 (LT-Q282B)	1000					203		4000				SI-B8T053280EU
LM 24x280mm 1000lm 865 20LED G1 (LT-Q282B)	1000					203		6500				SI-B8P053280EU

Linear Module (H-series)



LM18x1120mm 4000lm (LT-HB22D)



LM18x560mm 2000lm (LT-H562D)



LM18x280mm 1000lm (LT-H282D)

Product	Luminous Flux (lm)	Power Consumption (W)	Input Voltage (V)	IF (mA)	I _{max} (mA)	Efficacy (lm/W)	CRI	CCT (K)	Size (mm)	Temperature Range (°C)	Certification	Model Name
LM18x1120mm 4000lm 830 96LED G3 (LT-HB22D)	3980					184		3000				SI-B8V221B2HUS
LM18x1120mm 4000lm 835 96LED G3 (LT-HB22D)	4035					187		3500				SI-B8U221B2HUS
LM18x1120mm 4000lm 840 96LED G3 (LT-HB22D)	4150	21.6	22.5	960	2400	192	80+	4000	1120x18x5.8	-20~+50	cUL, UL	SI-B8T221B2HUS
LM18x1120mm 4000lm 850 96LED G3 (LT-HB22D)	4040					187		5000				SI-B8R221B2HUS
LM18x560mm 2000lm 830 48LED G3 (LT-H562D)	1990					184		3000				SI-B8V11156HUS
LM18x560mm 2000lm 835 48LED G3 (LT-H562D)	2020					187		3500				SI-B8U11156HUS
LM18x560mm 2000lm 840 48LED G3 (LT-H562D)	2075	10.8	22.5	480	1200	192	80+	4000	560x18x5.8	-20~+50	cUL, UL	SI-B8T11156HUS
LM18x560mm 2000lm 850 48LED G3 (LT-H562D)	2020					187		5000				SI-B8R11156HUS
LM18x280mm 1000lm 830 24LED G3 (LT-H282D)	1000					184		3000				SI-B8V05128HUS
LM18x280mm 1000lm 835 24LED G3 (LT-H282D)	1010					187		3500				SI-B8U05128HUS
LM18x280mm 1000lm 840 24LED G3 (LT-H282D)	1040	5.4	22.5	240	600	192	80+	4000	275x18x5.8	-20~+50	cUL, UL	SI-B8T05128HUS
LM18x280mm 1000lm 850 24LED G3 (LT-H282D)	1010					187		5000				SI-B8R05128HUS

Linear Module (M-series)



LM18x1120mm 5500lm (LT-MB22C Gen 3)

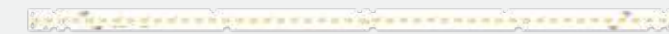

LM18x560mm 2800lm (LT-M562C Gen 3)



LM18x280mm 1800lm (LT-M282C Gen 3)

Product	Luminous Flux (lm)	Power Consumption (W)	Input Voltage (V)	IF (mA)	I _{max} (mA)	Efficacy (lm/W)	CRI	CCT (K)	Size (mm)	Temperature Range (°C)	Certification	Model Name
LM18x1120mm 5500lm 830 96LED G3 (LT-MB22C Gen 3)	5330					159		3000				SI-B8V341B2001
LM18x1120mm 5500lm 835 96LED G3 (LT-MB22C Gen 3)	5400					161		3500				SI-B8U341B2001
LM18x1120mm 5500lm 840 96LED G3 (LT-MB22C Gen 3)	5550	33.6	24	1400	2160	165	80+	4000	1120x18x5.2	-20~+50	cUL, UL	SI-B8T341B2001
LM18x1120mm 5500lm 850 96LED G3 (LT-MB22C Gen 3)	5550					165		5000				SI-B8R341B2001
LM18x560mm 2800lm 830 48LED G3 (LT-M562C Gen 3)	2665					159		3000				SI-B8V17256001
LM18x560mm 2800lm 835 48LED G3 (LT-M562C Gen 3)	2700					161		3500				SI-B8U17256001
LM18x560mm 2800lm 840 48LED G3 (LT-M562C Gen 3)	2775	16.8	24	700	1080	165	80+	4000	560x18x5.8	-20~+50	cUL, UL	SI-B8T17256001
LM18x560mm 2800lm 850 48LED G3 (LT-M562C Gen 3)	2775					165		5000				SI-B8R17256001
LM18x280mm 1800lm 830 24LED G3 (LT-M282C Gen 3)	1660					149		3000				SI-B8V11428001
LM18x280mm 1800lm 835 24LED G3 (LT-M282C Gen 3)	1680					151		3500				SI-B8U11428001
LM18x280mm 1800lm 840 24LED G3 (LT-M282C Gen 3)	1730	11.2	24.8	450	540	155	80+	4000	275x18x5.8	-20~+50	cUL, UL	SI-B8T11428001
LM18x280mm 1800lm 850 24LED G3 (LT-M282C Gen 3)	1730					155		5000				SI-B8R11428001

Linear Module (S-series Gen 3)



LM 24x560mm 2200lm 48LED G3 (LT-S562V)



LM 24x280mm 1100lm 24LED G3 (LT-S282V)

Product	Luminous Flux (lm)	Power Consumption (W)	Input Voltage (V)	IF (mA)	I _{max} (mA)	Efficacy (lm/W)	CRI	CCT (K)	Size (mm)	Temperature Range (°C)	Certification	Model Name
LM 24x560mm 2200lm 830 48LED G3 (LT-S562V)	2170					171		3000				SI-B8V12A56SEU
LM 24x560mm 2200lm 840 48LED G3 (LT-S562V)	2285	12.7	45.4	280	480	180	80+	4000	559.7×23.5×5.5	-20~+50	CE	SI-B8T12A56SEU
LM 24x560mm 2200lm 865 48LED G3 (LT-S562V)	2285					180		6500				SI-B8P12A56SEU
LM 24x280mm 1100lm 830 24LED G3 (LT-S282V)	1085					171		3000				SI-B8V06A28SEU
LM 24x280mm 1100lm 840 24LED G3 (LT-S282V)	1145	6.4	22.7	280	480	180	80+	4000	279.7×23.5×5.5	-20~+50	CE	SI-B8T06A28SEU
LM 24x280mm 1100lm 865 24LED G3 (LT-S282V)	1145					180		6500				SI-B8P06A28SEU
LM 24x560mm, 2200lm 930 48LED G3 (LT-S562V)	1845					145		3000				SI-B9V12A56SEU
LM 24x560mm, 2200lm 940 48LED G3 (LT-S562V)	1940	12.7	45.4	280	480	153	90+	4000	559.7×23.5×5.5	-20~+50	CE	SI-B9T12A56SEU
LM 24x560mm, 2200lm 965 48LED G3 (LT-S562V)	1940					153		6500				SI-B9P12A56SEU
LM 24x280mm 1100lm 930 24LED G3 (LT-S282V)	920					145		3000				SI-B9V06A28SEU
LM 24x280mm 1100lm 940 24LED G3 (LT-S282V)	975	6.4	22.7	280	480	153	90+	4000	279.7×23.5×5.5	-20~+50	CE	SI-B9T06A28SEU
LM 24x280mm 1100lm 965 24LED G3 (LT-S282V)	975					153		6500				SI-B9P06A28SEU



LM 24x560mm 1100lm 24LED G3 (LT-S562W)



LM 24x280mm 550lm 12LED G3 (LT-S282W)

Product	Luminous Flux (lm)	Power Consumption (W)	Input Voltage (V)	IF (mA)	I _{max} (mA)	Efficacy (lm/W)	CRI	CCT (K)	Size (mm)	Temperature Range (°C)	Certification	Model Name
LM 24x560mm 1100lm 830 24LED G3 (LT-S562W)	1085					171		3000				SI-B8V06A56SEU
LM 24x560mm 1100lm 840 24LED G3 (LT-S562W)	1145	6.4	22.7	280	480	180	80+	4000	559.7×23.5×5.5	-20~+50	CE	SI-B8T06A56SEU
LM 24x560mm 1100lm 865 24LED G3 (LT-S562W)	1145					180		6500				SI-B8P06A56SEU
LM 24x280mm 550lm 830 12LED G3 (LT-S282W)	540					169		3000				SI-B8V03A28SEU
LM 24x280mm 550lm 840 12LED G3 (LT-S282W)	570	3.2	11.4	280	480	179	80+	4000	279.7×23.5×5.5	-20~+50	CE	SI-B8T03A28SEU
LM 24x280mm 550lm 865 12LED G3 (LT-S282W)	570					179		6500				SI-B8P03A28SEU
LM 24x560mm 1100lm 930 24LED G3 (LT-S562W)	920					145		3000				SI-B9V06A56SEU
LM 24x560mm 1100lm 940 24LED G3 (LT-S562W)	975	6.4	22.7	280	480	153	90+	4000	559.7×23.5×5.5	-20~+50	CE	SI-B9T06A56SEU
LM 24x560mm 1100lm 965 24LED G3 (LT-S562W)	975					153		6500				SI-B9P06A56SEU
LM 24x280mm 550lm 930 12LED G3 (LT-S282W)	460					144		3000				SI-B9V03A28SEU
LM 24x280mm 550lm 940 12LED G3 (LT-S282W)	485	3.2	11.4	280	480	152	90+	4000	279.7×23.5×5.5	-20~+50	CE	SI-B9T03A28SEU
LM 24x280mm 550lm 965 12LED G3 (LT-S282W)	485					152		6500				SI-B9P03A28SEU

Linear Module (V-series)



LM18x1120mm 5600lm (LT-VB22C)



LM18x560mm 2800lm (LT-V562C)

Product	Luminous Flux (lm)	Power Consumption (W)	Input Voltage (V)	IF (mA)	Imax (mA)	Efficacy (lm/W)	CRI	CCT (K)	Size (mm)	Temperature Range (°C)	Certification	Model Name
LM18x1120mm 5600lm 830 96LED G2 (LT-VB22C)	5360					165		3000				SI-B8V342B2CUS
LM18x1120mm 5600lm 835 96LED G2 (LT-VB22C)	5440					167		3500				SI-B8U342B2CUS
LM18x1120mm 5600lm 840 96LED G2 (LT-VB22C)	5620	32.5	46.4	700	900	173	80+	4000	1120x18x5.5	-30~+50	cUL, UL	SI-B8T342B2CUS
LM18x1120mm 5600lm 850 96LED G2 (LT-VB22C)	5690					175		5000				SI-B8R342B2CUS
LM18x560mm 2800lm 830 48LED G2 (LT-V562C)	2680					165		3000				SI-B8V17256CWW
LM18x560mm 2800lm 835 48LED G2 (LT-V562C)	2720					167		3500				SI-B8U17256CWW
LM18x560mm 2800lm 840 48LED G2 (LT-V562C)	2810	16.2	23.2	700	900	173	80+	4000	560x18x5.5	-30~+50	cUL, UL	SI-B8T17256CWW
LM18x560mm 2800lm 850 48LED G2 (LT-V562C)	2845					175		5000				SI-B8R17256CWW

Linear Module (T-series)



LM18x560mm 2000lm (LT-T562C)



LM18x280mm 1000lm (LT-T282C)

Product	Luminous Flux (lm)	Power Consumption (W)	Input Voltage (V)	IF (mA)	Imax (mA)	Efficacy (lm/W)	CRI	CCT (K)	Size (mm)	Temperature Range (°C)	Certification	Model Name
	1900	13.5	18.0 / 0	750 / 0		141		2700				
LM18x560mm 2000lm 827-65 30LED G1 (LT-T562C)	2075	12.6	16.7 / 16.7	375 / 375	-	165	80+	4000	560x18x5.5	-20~+50	cUL, UL	SI-B8A131560WW
	2060	13.5	0 / 18.0	0 / 750		153		6500				
	950	6.8	9.0 / 0	750 / 0		141		2700				
LM18x280mm 1000lm 827-65 15LED G1 (LT-T282C)	1040	6.3	8.4 / 8.4	375 / 375	-	165	80+	4000	275x18x5.5	-20~+50	cUL, UL	SI-B8A071280WW
	1030	6.8	0 / 9.0	0 / 750		153		6500				

Standard Back-lit







Product	Luminous Flux (lm)	Power Consumption (W)	Input Voltage (V)	IF (mA)	I _{max} (mA)	Efficacy (lm/W)	CRI	CCT (K)	Size (mm)	Temperature Range (°C)	Certification	Model Name
Back-lit SE Static 2ft	610	3.7	41.5	88	200	167	80+	3000	500x13x6	-20~+50	CE, cUL, UL	SI-B8V031500WW
	620					170		3500				SI-B8U031500WW
	640					175		4000				SI-B8T031500WW
	650					178		5000				SI-B8R031500WW
Back-lit SE Static 4ft	1220	7.3	41.5	176	400	167	80+	3000	1100x13x6	-20~+50	CE, cUL, UL	SI-B8V071B00WW
	1240					170		3500				SI-B8U071B00WW
	1280					175		4000				SI-B8T071B00WW
	1300					178		5000				SI-B8R071B00WW
Back-lit SE Tunable 2ft	580	3.7	41.5	88	200	159	80+	2700	500x13x6	-20~+50	CE, cUL, UL	SI-B8A031500WW
	640							175				
Back-lit SE Tunable 4ft	1160	7.3	41.5	176	400	159	80+	2700	1100x13x6	-20~+50	CE, cUL, UL	SI-B8A071B00WW
	1280							175				



Superior performance for high flux luminaires in industrial lighting

- Optimized for industrial lighting applications
- Reduced thermal resistance using Samsung's high performing mid-power LEDs
- Better uniformity & cost effective

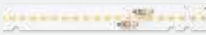
Product	Key Features	Efficacy (lm/W)	Lifespan
 H inFlux	<ul style="list-style-type: none"> • Wide lumen flux coverage - up to 40,000lm by combining modules • Highest performance • 192lm/W [4000K, CRI 80+, Tp 55°C] • Lifetime: 50,000 hours, Beam angle: 120° 	●●●●●	●●●●●
 M inFlux	<ul style="list-style-type: none"> • High lumen density of 18,600lm to replace tubes in high/low bay lighting • High performance • 176lm/W [4000K, CRI 80+, Tp 65°C] • Lifetime: 50,000 hours, Beam angle: 120° 	●●●●○	●●●●●
 L inFlux	<ul style="list-style-type: none"> • Value solution • 160lm/W [4000K, CRI 80+, Tp 65°C] • Lifetime: 50,000 hours, Beam angle: 118° 	●●●●○	●●●●○
 F-series	<ul style="list-style-type: none"> • High lumen density of 18,600lm to replace tubes in high/low bay lighting • Platform & flexible design choices • High efficacy up to 175lm/W @4000K • Lifetime: 50,000 hours, Beam angle: 115° 	●●●●○	●●●●○
 V-series F-type	<ul style="list-style-type: none"> • Value solution • 167lm/W [4000K, CRI80+, Tp 65°C] • Lifetime: 50,000 hours, Beam angle: 115° 	●●●●○	●●●●○

Linear Module (H inFlux)



LM 24x560mm 4000lm (H inFlux_L04)



LM 24x560mm 6000lm (H inFlux_L06)



LM 40x560mm 8000lm (H inFlux_L09)



LM 24x280mm 2000lm (H inFlux_S02)



LM 24x280mm 3000lm (H inFlux_S03)



LM 40x280mm 4000lm (H inFlux_S04)

Product	Luminous Flux (lm)	Power Consumption (W)	Input Voltage (V)	IF (mA)	Imax (mA)	Efficacy (lm/W)	CRI	CCT (K)	Size (mm)	Temperature Range (°C)	Certification	Model Name
LM 24x560mm 4000lm 830 64LED G1 (H inFlux_L04)	3960					178		3000				SL-B8V2N80LAWW
LM 24x560mm 4000lm 835 64LED G1 (H inFlux_L04)	4060	22.3	22.3	1000	1380	182	80+	3500	560x24x5.9	-40~+50	CE, cUL, UL	SL-B8U2N80LAWW
LM 24x560mm 4000lm 840 64LED G1 (H inFlux_L04)	4280					192		4000				SL-B8T2N80LAWW
LM 24x560mm 4000lm 850 64LED G1 (H inFlux_L04)	4280					192		5000				SL-B8R2N80LAWW
LM 24x560mm 6000lm 830 88LED G1 (H inFlux_L06)	5630					176		3000				SL-B8V3N80LAWW
LM 24x560mm 6000lm 835 88LED G1 (H inFlux_L06)	5800	32.0	22.4	1430	950	181	80+	3500	560x24x5.9	-40~+50	CE, cUL, UL	SL-B8U3N80LAWW
LM 24x560mm 6000lm 840 88LED G1 (H inFlux_L06)	6110					191		4000				SL-B8T3N80LAWW
LM 24x560mm 6000lm 850 88LED G1 (H inFlux_L06)	6110					191		5000				SL-B8R3N80LAWW
LM 40x560mm 8000lm 830 128LED G1 (H inFlux_L09)	7910					177		3000				SL-B8V4N90LAWW
LM 40x560mm 8000lm 835 128LED G1 (H inFlux_L09)	8130	44.6	44.6	1000	1380	182	80+	3500	561x41x5.9	-40~+50	CE, cUL, UL	SL-B8U4N90LAWW
LM 40x560mm 8000lm 840 128LED G1 (H inFlux_L09)	8570					192		4000				SL-B8T4N90LAWW
LM 40x560mm 8000lm 850 128LED G1 (H inFlux_L09)	8570					192		5000				SL-B8R4N90LAWW
LM 24x280mm 2000lm 830 32LED G1 (H inFlux_S02)	1980					178		3000				SL-B8V1N30LAWW
LM 24x280mm 2000lm 835 32LED G1 (H inFlux_S02)	2030	11.1	11.1	1000	1380	183	80+	3500	280x24x5.9	-40~+50	CE, cUL, UL	SL-B8U1N30LAWW
LM 24x280mm 2000lm 840 32LED G1 (H inFlux_S02)	2140					193		4000				SL-B8T1N30LAWW
LM 24x280mm 2000lm 850 32LED G1 (H inFlux_S02)	2140					193		5000				SL-B8R1N30LAWW
LM 24x280mm 3000lm 830 44LED G1 (H inFlux_S03)	2820					176		3000				SL-B8V1N60LAWW
LM 24x280mm 3000lm 835 44LED G1 (H inFlux_S03)	2890	16.0	11.2	1430	950	180	80+	3500	280x24x5.9	-40~+50	CE, cUL, UL	SL-B8U1N60LAWW
LM 24x280mm 3000lm 840 44LED G1 (H inFlux_S03)	3060					191		4000				SL-B8T1N60LAWW
LM 24x280mm 3000lm 850 44LED G1 (H inFlux_S03)	3060					191		5000				SL-B8R1N60LAWW
LM 40x280mm 4000lm 830 64LED G1 (H inFlux_S04)	3960					178		3000				SL-B8V2N70LAWW
LM 40x280mm 4000lm 835 64LED G1 (H inFlux_S04)	4060	22.3	22.3	1000	1380	182	80+	3500	281x41x5.9	-40~+50	CE, cUL, UL	SL-B8U2N70LAWW
LM 40x280mm 4000lm 840 64LED G1 (H inFlux_S04)	4280					192		4000				SL-B8T2N70LAWW
LM 40x280mm 4000lm 850 64LED G1 (H inFlux_S04)	4280					192		5000				SL-B8R2N70LAWW

Linear Module (M inFlux)



M inFlux S04



M inFlux L04



M inFlux L09



M inFlux F09



M inFlux F18



M inFlux S04 CRI90



M inFlux L04 CRI90



M inFlux L09 CRI90

Product	Luminous Flux (lm)	Power Consumption (W)	Input Voltage (V)	IF (mA)	Imax (mA)	Efficacy (lm/W)	CRI	CCT (K)	Size (mm)	Temperature Range (°C)	Certification	Model Name
M inFlux S04	4300	25.8	23	1120	2800	167	80+	3000	280x40x5.5	-40~+65	CE, cUL, UL	SI-B8V251280WW
	4380					170		3500				SI-B8U251280WW
	4510					175		4000				SI-B8T251280WW
	4560					177		5000				SI-B8R251280WW
M inFlux L04	4300	25.8	23	1120	2800	167	80+	3000	560x18x5.5	-40~+65	CE, cUL, UL	SI-B8V251560WW
	4380					170		3500				SI-B8U251560WW
	4510					175		4000				SI-B8T251560WW
	4560					177		5000				SI-B8R251560WW
M inFlux L09	8560	51.4	45.9	1120	2800	167	80+	3000	560x40x5.5	-40~+65	CE, cUL, UL	SI-B8V501560WW
	8740					170		3500				SI-B8U501560WW
	9030					176		4000				SI-B8T501560WW
	9130					178		5000				SI-B8R501560WW
M inFlux F09	8560	51.4	45.9	1120	2800	167	80+	3000	1120x18x5.5	-40~+65	CE, cUL, UL	SI-B8V501B20WW
	8740					170		3500				SI-B8U501B20WW
	9030					176		4000				SI-B8T501B20WW
	9130					178		5000				SI-B8R501B20WW
M inFlux F18	17120	105.1	46.9	2240	3500	163	80+	3000	1120x40x5.5	-40~+65	CE, cUL, UL	SI-B8VA01B20WW
	17480					166		3500				SI-B8UA01B20WW
	18060					172		4000				SI-B8TA01B20WW
	18100					172		5000				SI-B8RA01B20WW
M inFlux S04 CRI90	3570	25.8	23	1120	2800	139	90+	3000	280x40x5.5	-40~+65	CE, cUL, UL	SI-B9V251280WW
	3690					143		3500				SI-B9U251280WW
	3800					148		4000				SI-B9T251280WW
	3860					150		5000				SI-B9R251280WW
M inFlux L04 CRI90	3570	25.8	23	1120	2800	139	90+	3000	560x18x5.5	-40~+65	CE, cUL, UL	SI-B9V251560WW
	3690					143		3500				SI-B9U251560WW
	3800					148		4000				SI-B9T251560WW
	3860					150		5000				SI-B9R251560WW
M inFlux L09 CRI90	7160	51.4	45.9	1120	2800	139	90+	3000	560x40x5.5	-40~+65	CE, cUL, UL	SI-B9V501560WW
	7400					144		3500				SI-B9U501560WW
	7630					148		4000				SI-B9T501560WW
	7760					151		5000				SI-B9R501560WW

Linear Module (L inFlux)



L inFlux L09



L inFlux S04

Product	Luminous Flux (lm)	Power Consumption (W)	Input Voltage (V)	IF (mA)	I _{max} (mA)	Efficacy (lm/W)	CRI	CCT (K)	Size (mm)	Temperature Range (°C)	Certification	Model Name
L inFlux L09	8470	57.0	45.6	1250	1500	149	80+	3000	559.7x39.8x6	-20~+50	CE, cUL, UL	SI-B8V581560EU
	9030					158		4000				SI-B8T581560EU
L inFlux S04	4270	28.5	22.8	1250	1500	150	80+	3000	279.7x39.8x6	-20~+50	CE, cUL, UL	SI-B8V291280EU
	4550					160		4000				SI-B8T291280EU

Linear Module (F-series)



LM 18x1120mm 9000lm (LT-FB22B)



LM 40x1120mm 18000lm (LT-FB24B)



LM 18x560mm 4500lm (LT-F562B)

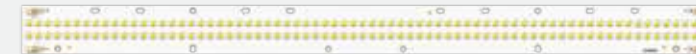

LM 40x560mm 9000lm (LT-F564B)

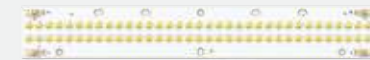

LM 40x280mm 4500lm (LT-F284B)

Product	Luminous Flux (lm)	Power Consumption (W)	Input Voltage (V)	IF (mA)	I _{max} (mA)	Efficacy (lm/W)	CRI	CCT (K)	Size (mm)	Temperature Range (°C)	Certification	Model Name
LM 18x1120mm 9000lm 830 144LED G3 (LT-FB22B)	8670	51.5	46.0	1120	1800	168	80+	3000	1120x18x5.2	-30~+55	cUL, UL	SI-B8V521B20WW
LM 18x1120mm 9000lm 835 144LED G3 (LT-FB22B)	8800					171		3500				SI-B8U521B20WW
LM 18x1120mm 9000lm 840 144LED G3 (LT-FB22B)	9000					175		4000				SI-B8T521B20WW
LM 18x1120mm 9000lm 850 144LED G3 (LT-FB22B)	9300					181		5000				SI-B8R521B20WW
LM 40x1120mm 18000lm 830 288LED G3 (LT-FB24B)	17340	103.0	46.0	2240	3600	168	80+	3000	1120x39.8x5.2	-30~+55	cUL, UL	SI-B8V291B20WW
LM 40x1120mm 18000lm 835 288LED G3 (LT-FB24B)	17600					171		3500				SI-B8U291B20WW
LM 40x1120mm 18000lm 840 288LED G3 (LT-FB24B)	18000					175		4000				SI-B8T291B20WW
LM 40x1120mm 18000lm 850 288LED G3 (LT-FB24B)	18600					181		5000				SI-B8R291B20WW
LM 18x560mm 4500lm 830 72LED G3 (LT-F562B)	4335	25.8	23.0	1120	1800	168	80+	3000	560x18x5.2	-30~+55	cUL, UL	SI-B8V261560WW
LM 18x560mm 4500lm 835 72LED G3 (LT-F562B)	4400					171		3500				SI-B8U261560WW
LM 18x560mm 4500lm 840 72LED G3 (LT-F562B)	4500					175		4000				SI-B8T261560WW
LM 18x560mm 4500lm 850 72LED G3 (LT-F562B)	4650					181		5000				SI-B8R261560WW
LM 40x560mm 9000lm 830 144LED G3 (LT-F564B)	8670	51.5	46.0	1120	1800	168	80+	3000	559.7x39.8x5.2	-30~+55	cUL, UL	SI-B8V521560WW
LM 40x560mm 9000lm 835 144LED G3 (LT-F564B)	8800					171		3500				SI-B8U521560WW
LM 40x560mm 9000lm 840 144LED G3 (LT-F564B)	9000					175		4000				SI-B8T521560WW
LM 40x560mm 9000lm 850 144LED G3 (LT-F564B)	9300					181		5000				SI-B8R521560WW
LM 40x280mm 4500lm 830 72LED G3 (LT-F284B)	4335	25.8	23.0	1120	1800	168	80+	3000	280x40x5.2	-30~+55	cUL, UL	SI-B8V261280WW
LM 40x280mm 4500lm 835 72LED G3 (LT-F284B)	4400					171		3500				SI-B8U261280WW
LM 40x280mm 4500lm 840 72LED G3 (LT-F284B)	4500					175		4000				SI-B8T261280WW
LM 40x280mm 4500lm 850 72LED G3 (LT-F284B)	4650					181		5000				SI-B8R261280WW

Linear Module (V-series F-type)



LM 40x1120mm 9000lm 288LED G2 (LT-VB24F)



LM 18x1120mm 8500lm 144LED G2 (LT-VB22F)



LM 18x560mm 4000lm 72LED G2 (LT-V562F)





LM 40x560mm 8500lm 144LED G2 (LT-V564F)

Product	Luminous Flux (lm)	Power Consumption (W)	Input Voltage (V)	IF (mA)	Imax (mA)	Efficacy (lm/W)	CRI	CCT (K)	Size (mm)	Temperature Range (°C)	Certification	Model Name
LM 40x1120mm 9000lm 288LED G2 (LT-VB24F)	8350	47.5	44.0	1080	-	176	80+	3000	1120x39.8x5.2	-20~+50	cUL, UL	SI-B8V481B20US
	8620					181		3500				SI-B8U481B20US
	8950					188		4000				SI-B8T481B20US
	8740					184		5000				SI-B8R481B20US
LM 18x1120mm 8500lm 144LED G2 (LT-VB22F)	8300	52.1	46.5	1120	1350	159	80+	3000	1120x18x5.5	-30~+50	cUL, UL	SI-B8V522B2CUS
	8410					161		3500				SI-B8U522B2CUS
	8690					167		4000				SI-B8T522B2CUS
	8800					169		5000				SI-B8R522B2CUS
LM 18x560mm 4000lm 72LED G2 (LT-V562F)	4150	26.1	23.3	1120	1350	159	80+	3000	560x18x5.5	-30~+50	cUL, UL	SI-B8V26256CUS
	4205					161		3500				SI-B8U26256CUS
	4345					168		4000				SI-B8T26256CUS
	4400					169		5000				SI-B8R26256CUS
LM 40x560mm 8500lm 144LED G2 (LT-V564F)	8300	52.1	46.5	1120	1350	159	80+	3000	560x39.8x5.5	-30~+50	cUL, UL	SI-B8V52256CUS
	8410					161		3500				SI-B8U52256CUS
	8690					167		4000				SI-B8T52256CUS
	8800					169		5000				SI-B8R52256CUS



High efficacy modules that are ideal for use in downlights and spotlights

- High efficacy downlight modules with latest LED technology from Samsung
- Suitable for various applications including general flood light, spotlight, ceiling light, flushmount and fan light
- Best color consistency derived from Samsung's extensive binning expertise

Product	Key Features	Efficacy (lm/W)	Lifespan
 Circular Module G5 (Round Gen 5)	<ul style="list-style-type: none"> • High luminous efficacy for reduced electricity costs • Possible to design 4-8inch downlight • Lifetime: 50,000 hours, Beam angle: 115° 	●●●●●	●●●●○
 Circular Engine 120mm G2 (Round ACOM Gen 2)	<ul style="list-style-type: none"> • Easy installation (No external driver required) • Cost competitive with good lm/\$ • Lifetime: 50,000 hours, Beam angle: 115° 	●●●●○	●●●●○
 Circular Engine 100mm (T-24 ACOM)	<ul style="list-style-type: none"> • Flicker-free(%Flicker < 30%), Dimming to 10% brightness with good dimmer compatibility • Designed following CEC Title-24 standard • Lifetime: 50,000 hours, Beam angle: 115° 	●●●●○	●●●●○

Circular Module G5 (Round Gen 5)

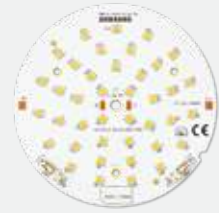

CM 90mm 1000lm G5



CM 110mm 2000lm G5

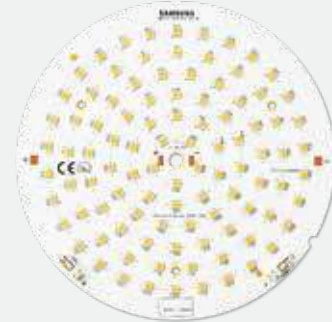

CM 130mm 3000lm G5

Type	Luminous Flux (lm)	Power Consumption (W)	Input Voltage (V)	IF (mA)	Imax (mA)	Efficacy (lm/W)	Tp (°C)	CRI	CCT (K)	Size (mm)	Temperature Range (°C)	Certification	Model Name
CM 90mm 1000lm 830 G5 (Round-090)	1190					178			3000				SI-N8V0754B0WW
CM 90mm 1000lm 835 G5 (Round-090)	1210					181			3500				SI-N8U0754B0WW
CM 90mm 1000lm 840 G5 (Round-090)	1240	6.7	27.5	240	480	186	25	80+	4000	Φ90x5.2	-20~+50	UL	SI-N8T0754B0WW
CM 90mm 1000lm 850 G5 (Round-090)	1250					187			5000				SI-N8R0754B0WW
CM 90mm 1000lm 857 G5 (Round-090)	1250					187			5700				SI-N8Q0754B0WW
CM 110mm 2000lm 830 G5 (Round-110)	2130					178			3000				SI-N8V1254B0WW
CM 110mm 2000lm 835 G5 (Round-110)	2150					180			3500				SI-N8U1254B0WW
CM 110mm 2000lm 840 G5 (Round-110)	2210	12.0	27.8	430	840	185	25	80+	4000	Φ110x5.2	-20~+50	UL	SI-N8T1254B0WW
CM 110mm 2000lm 850 G5 (Round-110)	2240					187			5000				SI-N8R1254B0WW
CM 110mm 2000lm 857 G5 (Round-110)	2230					186			5700				SI-N8Q1254B0WW
CM 130mm 3000lm 830 G5 (Round-130)	3170					178			3000				SI-N8V1856B0WW
CM 130mm 3000lm 835 G5 (Round-130)	3210					180			3500				SI-N8U1856B0WW
CM 130mm 3000lm 840 G5 (Round-130)	3310	17.9	27.9	640	1200	185	25	80+	4000	Φ130x5.2	-20~+50	UL	SI-N8T1856B0WW
CM 130mm 3000lm 850 G5 (Round-130)	3350					188			5000				SI-N8R1856B0WW
CM 130mm 3000lm 857 G (Round-130)	3330					186			5700				SI-N8Q1856B0WW

Circular Engine 120mm G2 (Round ACOM Gen 2)

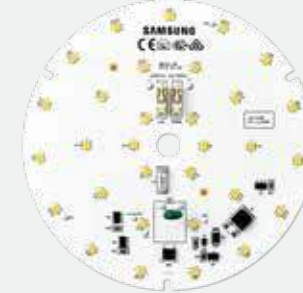

CE 120mm 1400lm EU G2

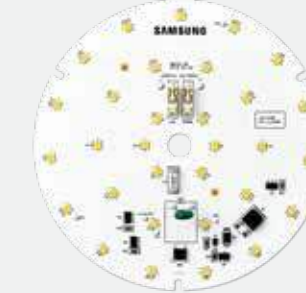

CE 120mm 1400lm KR

Product	Luminous Flux (lm)	Power Consumption (W)	Input Voltage (V)	Flicker (%)	THD (%)	Efficacy (lm/W)	Tp (°C)	CRI	CCT (K)	Size (mm)	Temperature Range (°C)	Certification	Model Name
CE 120mm 1400lm 827 G2 (Round ACOM EU Gen 2)	1430					118			2700				SI-N8W1225B1EU
CE 120mm 1400lm 830 G2 (Round ACOM EU Gen 2)	1440	12.1	230(AC)	100	15	119	25	80+	3000	Φ120x5.5	-20~+40	CE, ENEC	SI-N8V1225B1EU
CE 120mm 1400lm 840 G2 (Round ACOM EU Gen 2)	1550					128			4000				SI-N8T1225B1EU
CE 120mm 1400lm 857 (Round ACOM KR)	1460	11.2	220(AC)	100	18	130	25	80+	5700	Φ120x5.5	-20~+40	-	SI-N8Q1115B1KR

Circular Engine 100mm (T-24 ACOM)



CE 100mm 1500lm (T-24 ACOM)

Product	Luminous Flux (lm)	Power Consumption (W)	Input Voltage (V)	Flicker (%)	THD (%)	Efficacy (lm/W)	Tp (°C)	CRI	CCT (K)	Size (mm)	Temperature Range (°C)	Certification	Model Name
CE 100mm 1500lm 927 (T-24 ACOM)	1530					94			2700				SI-N9W1624B1US
CE 100mm 1500lm 930 (T-24 ACOM)	1540					95			3000				SI-N9V1624B1US
CE 100mm 1500lm 935 (T-24 ACOM)	1600	16.2	120(AC)	< 30	11	99	25	90+	3500	Φ100x11	-20~+40	cUL, UL, Title 24	SI-N9U1624B1US
CE 100mm 1500lm 940 (T-24 ACOM)	1620					100			4000				SI-N9T1624B1US



Rectangular Module (Modular Platform Engine)

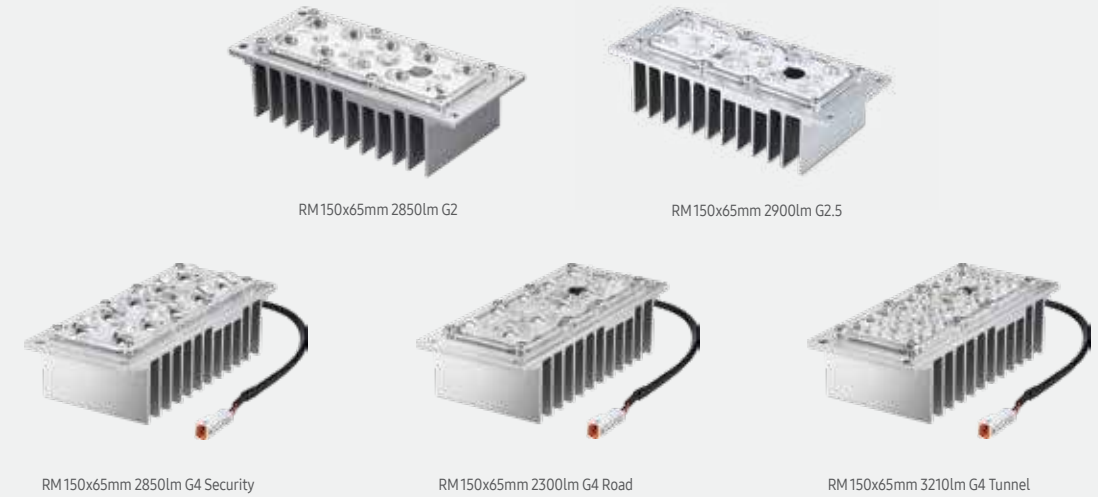

Easy-to-use modular design with various lumen packages combined with IP66-certified durability, makes it the smart choice for use in the harshest of environments

- Wide range of engine combinations well-suited for a variety of harsh environment applications
- High luminous efficacy
- Available with a full range of compatible drivers

Product	Key Features	Efficacy (lm/W)	Lifespan
<p>Rectangular Module (Modular Platform Engine)</p>	<ul style="list-style-type: none"> • Total solution integrating LED+Optics+Thermal • Seamless Combination by modular design • IP66 	●●●●○	●●●●○
<p>Circular/Square/Rectangular Module (HiLOM)</p>	<ul style="list-style-type: none"> • Greater design flexibility for various fixture designs • Commercial lens available 	●●●●●	●●●●○

Model	Light Distribution Type	Connection Type	Luminous Flux (lm)	Power Consumption (W)	Input Voltage (V)	IF (mA)	Imax (mA)	Efficacy (lm/W)	CRI	CCT (K)	Weight (g)	Temperature Range (°C)	Certification	Model Name		
RM 150x65mm 2850lm 7xx G2 (T-type Gen 2, 3535)	Type2 Medium	Wire	2650	21	30.0	700	1000	128	70+	3000	295	+10~+92	CE,UL	SL-P7V2W52MBGL		
			2800	21	30.0	700	1000	135	70+	4000	295	+10~+92	CE,UL	SL-P7T2W52MBGL		
			2850	21	30.0	700	1000	136	70+	5000	295	+10~+92	CE,UL	SL-P7R2W52MBGL		
	Type5		2650	21	30.0	700	1000	128	70+	3000	295	+10~+92	CE,UL	SL-P7V2W55SBGL		
			2800	21	30.0	700	1000	135	70+	4000	295	+10~+92	CE,UL	SL-P7T2W55SBGL		
			2850	21	30.0	700	1000	136	70+	5000	295	+10~+92	CE,UL	SL-P7R2W55SBGL		
			2850	21	30.0	700	1000	135	70+	5000	295	+10~+92	CE,UL	SL-PGR2W51SBGL		
			2850	21	30.0	700	1000	135	70+	4000	295	+10~+92	CE,UL	SL-PGT2W57SBGL		
			2850	21	30.0	700	1000	135	70+	5000	295	+10~+92	CE,UL	SL-PGR2W52SBGL		
			2850	21	30.0	700	1000	135	70+	5000	295	+10~+92	CE,UL	SL-PGR2W52SBGL		
RM 150x65mm 2900lm 8xx G2.5 (T-type Gen 2.5, CSP)	Type2 Short	Wire-harness	2600	20	28.0			130		3000	290				SL-P8V2W6RA1WW	
			2800	20	28.0	700	1000	140	80+	4000	290	+10~+92	CE,UL	SL-P8T2W6RA1WW		
			2900	20	28.0			145		5000	290				SL-P8R2W6RA1WW	
	Type1 Very Short		2900	20	28.0			145		5700	290					SL-P8Q2W6RA1WW
			2800	20	28.0			140		4000	290					SL-P8T2W6SA1WW
			2900	20	28.0	700	1000	145	80+	5000	290	+10~+92	CE,UL	SL-P8R2W6SA1WW		
			2900	20	28.0	700	1000	145	80+	5000	290	+10~+92	CE,UL	SL-P8R2W6TA1WW		
			2900	20	28.0			145		5700	290					SL-P8Q2W6TB1WW
RM 150x65mm 3190lm 7xx G4 (T-type Gen 4, 3535)	Type2 Medium	Wire	2910	21	30.0	700	1000	144	70+	3000	295	+10~+92	CE,UL	SL-P7V2W62MCGL		
			3100	21	30.0	700	1000	153	70+	4000	295	+10~+92	CE,UL	SL-P7T2W62MCGL		
			3190	21	30.0	700	1000	158	70+	5000	295	+10~+92	CE,UL	SL-P7R2W62MCGL		
	Type5		2910	21	30.0	700	1000	144	70+	3000	295	+10~+92	CE,UL	SL-P7V2W65SCGL		
			3100	21	30.0	700	1000	153	70+	4000	295	+10~+92	CE,UL	SL-P7T2W65SCGL		
3190	21	30.0	700	1000	158	70+	5000	295	+10~+92	CE,UL	SL-P7R2W65SCGL					
RM 150x65mm 2850lm 750 G4 (T-type Gen 4, 3535, Security)	Type1 Short	Wire-harness	2850	20	29.0			143		3500	295	+10~+92	-	SL-P7U1E6SACKR		
RM 150x65mm 2300lm 750 G4 (T-type Gen 4, 3535, Road)	Type2 Medium		2300	14	20.0	700	1000	164	75+	5000	295	+10~+92	-	SL-PFR1E33LCWW		
RM 150x65mm 3210lm 750 G4 (T-type Gen 4, 3030, Tunnel)	Type3 Very short		3210	18	25.4			178		5000	295	+10~+92	-	SL-P8R1E63MAWW		

Circular/Square/Rectangular Module (HiLOM)



CM 250mm 25700lm (HiLOM-HCF0)



SM 73x73mm 7200lm (HiLOM-SC16)



SM 81x81mm 4700lm (HiLOM-SC28)



SM 81x81mm 2430lm (HiLOM-SM28)

Model	Light Distribution Type	Connection Type	Luminous Flux (lm)	Power Consumption (W)	Input Voltage (V)	IF (mA)	I _{max} (mA)	Efficacy (lm/W)	CRI	CCT (K)	Weight (g)	Temperature Range (°C)	Certification	Model Name
CM 250mm 25700lm 740 G1 (HiLOM-HCF0)	Ledil VICTORIA HB		25700	148.8	45.1	3300	3630	173	70+		240			SL-B7TANB0L2WW
SM 73x73mm 7200lm 740 G1 (HiLOM-SC16)	Ledil STRADA 2*2 MX		7200	59.3	24.9	2100	2310	138	70+		17.5			SL-B7T5N90L2WW
SM 81x81mm 4700lm 740 G1 (HiLOM-SC28)	Ledil STRADELLA-IP-28	Connector	4700	27.7	19.8	1400	1540	171	70+		21.2	-30~+80	CE, UL	SL-B7T2N80L2WW
SM 81x81mm 2430lm 840 G1 (HiLOM-SM28)	Ledil STRADELLA-IP-28		2430	13.8	19.7	700	770	176	80+		21.2			SL-B8T1N50L4WW



RM 225x50mm 5550lm (HiLOM-RM64)



RM 146x45mm 4050lm (HiLOM-RH12)



RM 225x50mm 5400lm (HiLOM-RH16)

Model	Light Distribution Type	Connection Type	Luminous Flux (lm)	Power Consumption (W)	Input Voltage (V)	IF (mA)	I _{max} (mA)	Efficacy (lm/W)	CRI	CCT (K)	Weight (g)	Temperature Range (°C)	Certification	Model Name
RM 225x50mm 5550lm 840 G1 (HiLOM-RM64)	Ledil STRADELLA16 HB		5550	31.5	22.5	1400	1540	176	80+		40.0			SL-B8T3N80L4WW
RM 146x45mm 4050lm 740 G1 (HiLOM-RH12)	Ledil STRADA IP 2*6	Connector	4050	24.7	23.4	700	770	164	70+	4000	32.5	-30~+80	CE, UL	SL-B7T2N70LCWW
RM 225x50mm 5400lm 740 G1 (HiLOM-RH16)	Ledil STRADA 2*2		5400	32.9	23.5	1400	1540	164	70+		40.0			SL-B7T3N80LCWW

Driver



- Ambient Light
- Down & Spot Light
- Outdoor Light

Ambient Light



SI-CU7014011KR

Part Number	Power Consumption (W)	Size (mm)	Input Voltage (V)	Output Voltage (V)	Output Current/ch (mA)	Efficiency (%)	THD (%)	Dimming	Certification	Power Factor	Remark
SI-CU7014011KR	40	160 x 46.4 x 30.8	120-277	25-50	500-700	87	<20	1-10V	KC	>0.9	Output current adjustable by Rset

Down & Spot Light



SI-C242120N1KR

Part Number	Power Consumption (W)	Size (mm)	Input Voltage (V)	Output Voltage (V)	Output Current/ch (mA)	Efficiency (%)	THD (%)	Dimming	Certification	Power Factor	Remark
SI-C242120N1KR	20	94.5 x 39.5 x 31	220-240	25-40	420	86	<10	Non Dim	KC	>0.9	Fixed current

Outdoor Light



SL-L27012517KR



SL-L21425017KR
SL-L22127517KR
SL-L2282A017KR



SL-L2422A517KR
SL-L2562B017KR

Part Number	Power Consumption (W)	Size (mm)	Input Voltage (V)	Output Voltage (V)	Output Current/ch (mA)	Efficiency (%)	THD (%)	Dimming	Certification	Power Factor	Remark
SL-L27012517KR	25				700	86				>0.9	
SL-L21425017KR	50				1400	86.5					
SL-L22127517KR	75	265 x 70 x 48.5	220-240	27-33	2100	87	<20	1-10V	KC, KS	>0.95	Independent Type, IP67, Molex, <THD 30%@1V Dimming, High Surge (±8-10KV)
SL-L2282A017KR	100				2800	88.5					
SL-L2422A517KR	150				4200	90.5					
SL-L2562B017KR	200				5600	91					



SL-L27012518KR



SL-L21425018KR
SL-L22127518KR
SL-L2282A018KR



SL-L2422A518KR
SL-L2562B018KR

Part Number	Power Consumption (W)	Size (mm)	Input Voltage (V)	Output Voltage (V)	Output Current/ch (mA)	Efficiency (%)	THD (%)	Dimming	Certification	Power Factor	Remark
SL-L27012518KR	25				700	86				>0.9	
SL-L21425018KR	50				1400	86.5					
SL-L22127518KR	75	265 x 70 x 48.5	220-240	27-33	2100	87	<20	1-10V	KC, KS	>0.95	Independent Type, IP67, Waterproof JST, High Surge (±8-10KV)
SL-L2282A018KR	100				2800	88.5					
SL-L2422A518KR	150				4200	90.5					
SL-L2562B018KR	200				5600	91					

Outdoor Light



SL-L21425019KR SL-L22127519KR SL-L2701251BKR



SL-L2212751BKR SL-L2562B01BKR

Part Number	Power Consumption (W)	Size (mm)	Input Voltage (V)	Output Voltage (V)	Output Current/ch (mA)	Efficiency (%)	THD (%)	Dimming	Certification	Power Factor	Remark
SL-L21425019KR	50	182 x 69 x 39.5	220-240	27-33	700	88	<20	Non Dim	KC, KS	>0.95	Independent Type, 2Channel, Available KS cert, KET Connector
SL-L22127519KR	75	182 x 69 x 39.5	220-240	27-33	700	90	<20	Non Dim	KC, KS	>0.95	Independent Type, 3Channel, Available KS cert, KET Connector
SL-L2701251BKR	25	192.6x53.6x33.9	220-240	22-27	700	87.5	<20	1-10V	KS	>0.9	
SL-L2212751BKR	75	192.6x53.6x33.9	220-240	22-27	2100	90	<20	1-10V	KS	>0.95	Independent type, IP67, Molex, <THD 30%@1V Dimming, High Surge (±6-8KV)
SL-L2562B01BKR	200	192.6x53.6x33.9	220-240	22-27	5600	91	<20	1-10V	KS	>0.95	

Outdoor Light



SL-L2701151AKR
SL-L2701251AKR SL-L2701301AKR
SL-L2701401AKR
SL-L2701501AKR SL-L2701751AKR
SL-L2701A01AKR SL-L2701A51AKR
SL-L2701B01AKR

Part Number	Power Consumption (W)	Size (mm)	Input Voltage (V)	Output Voltage (V)	Output Current/ch (mA)	Efficiency (%)	THD (%)	Dimming	Certification	Power Factor	Remark
SL-L2701151AKR	15	177 x 40 x 37	220-240	18-33	700	84	<20	1-10V	KS	>0.9	Independent Type, IP67, KET
SL-L2701251AKR	25					85					
SL-L2701301AKR	30	210 x 40 x 37	220-240	39-63	700	86	<20	1-10V	KS	>0.9	
SL-L2701401AKR	40			87							
SL-L2701501AKR	50			88							
SL-L2701751AKR	75	182 x 66 x 38.8	220-240	85-125	700	89	<20	1-10V	KS	>0.9	
SL-L2701A01AKR	100					90					
SL-L2701A51AKR	150	228 x 68 x 39.5	220-240	177-243	700	91	<20	1-10V	KS	>0.9	
SL-L2701B01AKR	200					92					



SL-L2701A5N1KR



SL-L2701B0N1KR

Part Number	Power Consumption (W)	Size (mm)	Input Voltage (V)	Output Voltage (V)	Output Current/ch (mA)	Efficiency (%)	THD (%)	Dimming	Certification	Power Factor	Remark
SL-L2701A5N1KR	150	258 x 68 x 33.9	220-240	80-100	700	92	<20	Non Dim	KS	>0.9	Independent Type, 2Channel, IP67, KET
SL-L2701B0N1KR	200			100-130		93					

Outdoor Light

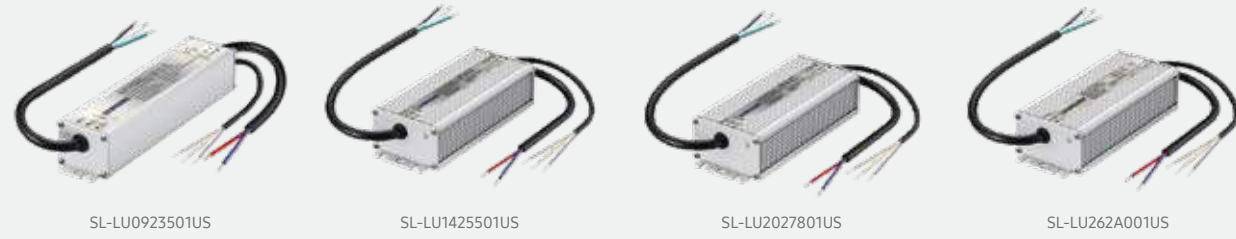

Part Number	Power Consumption (W)	Size (mm)	Input Voltage (V)	Output Voltage (V)	Output Current/ch (mA)	Efficiency (%)	THD (%)	Dimming	Certification	Power Factor	Remark
SL-LU0923501US	35	193 × 42.5 × 34.5	120-277	30-39	700-1050	87	<20	0-10V	cUL, UL	>0.9	Programmable Output Current, IP67
SL-LU1425501US	55	173 × 67.5 × 40			1400						
SL-LU2027801US	78	173 × 67.5 × 40	120-277	30-39	2000	88	<20	0-10V	cUL, UL	>0.9	Independent Type, IP67
SL-LU262A001US	100	187 × 67.5 × 40			2600						



Part Number	Power Consumption (W)	Size (mm)	Input Voltage (V)	Output Voltage (V)	Output Current/ch (mA)	Efficiency (%)	THD (%)	Dimming	Certification	Power Factor	Remark
SL-LA422C201WW	320	251×90×44.5	120-277	46-114	2800-4200	93	<20	0-10V	cUL, UL	>0.95	Independent type, IP67

Outdoor Light



Part Number	Power Consumption (W)	Size (mm)	Input Voltage (V)	Output Voltage (V)	Output Current/ch (mA)	Efficiency (%)	THD (%)	Dimming	Certification	Power Factor	Remark
SL-LU70140D1WW	40	135×68×31.4		30-56	350-700	89		DALI 2.0	CE, RCM		
SL-LUH517501WW	75	145×67.5×36.5		22-63	1190-1750	90					
SL-LU2129601WW	96	161×67.5×36.5		24-69	1400-2100	91					
SL-LU352A501WW	150	171×67.5×36.5		22-61	2450-3500	91.5					
SL-LU212A501WW	150	171×67.5×36.5	120-277	38-107	1400-2100	92.5	<20				Independent type, Programmable Output Current, IP67
SL-LU562B001WW	200	202×67.5×39.7		18-52	3850-5600	92		0-10V	cUL, UL	>0.9	
SL-LU352B001WW	200	202×67.5×39.7		29-82	2450-3500	93					
SL-LU672B401WW	240	212×67.5×39.7		18-52	4600-6700	92					
SL-LU422B401WW	240	212×67.5×39.7		29-86	2800-4200	92.5					
SL-LU672C201WW	320	224×80×39.7		24-68	4690-6700	92.5					

Specialty Lighting

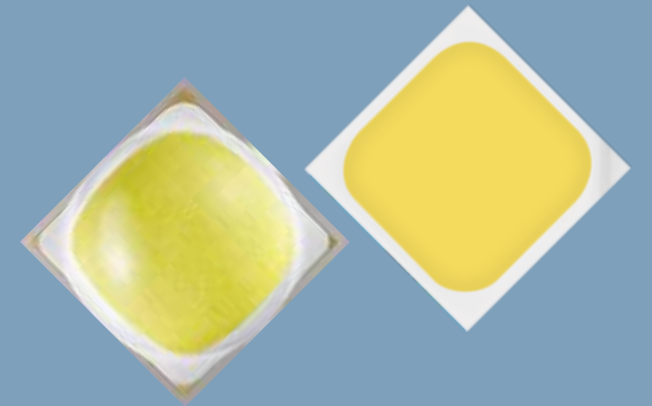
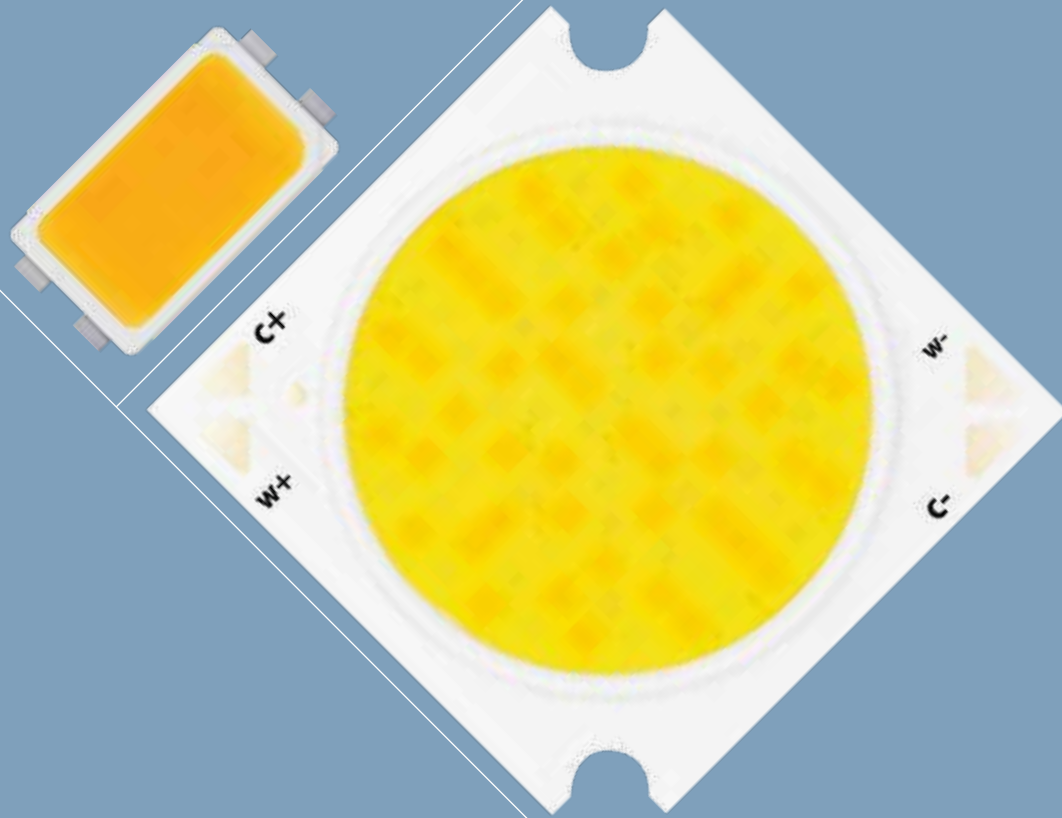
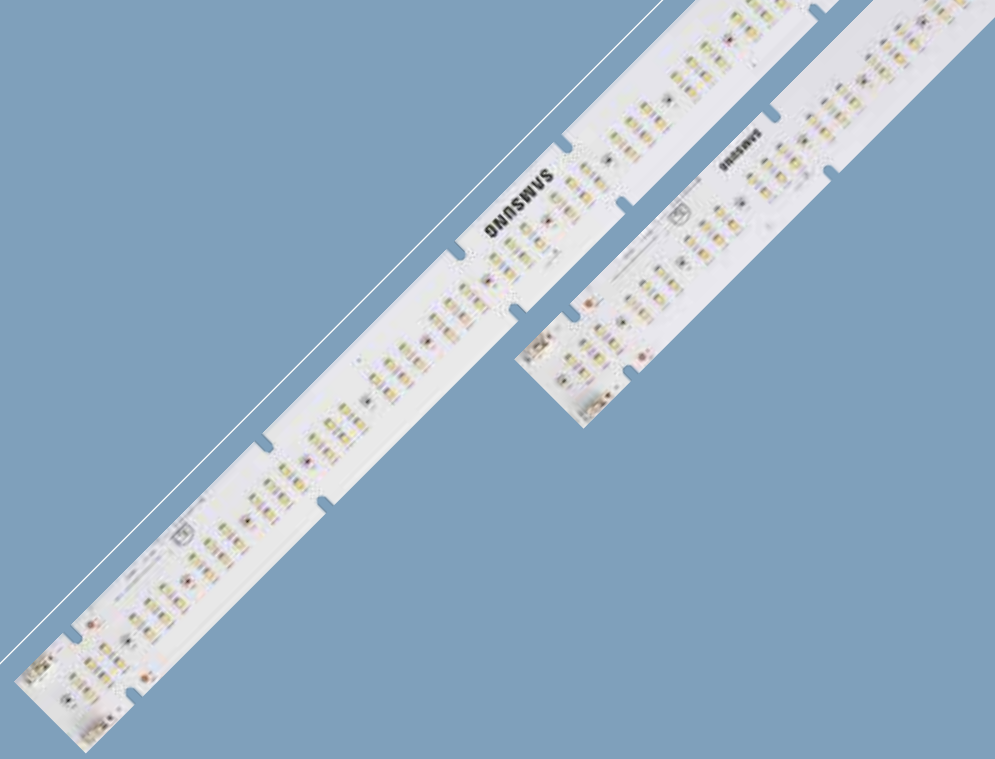

- Human-centric Light
- Horticulture Light
- Retail Light
- Sports Light



New human-centric lighting solutions with increased biological index compared to conventional LED lighting

- Designed to improve work efficiency in achieving daytime-to-evening continuity, healthy sleep and circadian rhythm 24 hours a day

LM302N DAY

Fine-tuned spectrum for more energetic moments

- 0.9W class mid power LED
- EMC package for high reliability
- Standard form factor for design flexibility (3.0mmx3.0mm)
- Patent registered for optimized spectrum

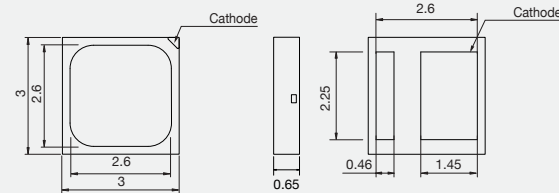

[150mA, 25°C]

CRI	CCT (K)	Part Number	Luminous Flux (lm)		M/P Ratio*	MDER **
			Bin	Range		
80+	3000	SPMWH3326FC5FBV☆S0	S0	110-125	0.65	0.59
	3500	SPMWH3326FC5FBU☆S0	S0	110-125	0.74	0.67
	4000	SPMWH3326FC5FBT☆S0	S0	115-125	0.84	0.76
	5000	SPMWH3326FC5FBR☆S0	S0	115-130	1.03	0.93
	5700	SPMWH3326FC5FBQ☆S0	S0	115-130	1.14	1.03
	6500	SPMWH3326FC5FBP☆S0	S0	115-130	1.24	1.12

☆ ☆ can be "0" (MacAdam 5 step), "3" (MacAdam 3 step), "Y" (Kitting)

* M/P Ratio: Melanopic/Photopic Ratio

** MDER: Melanopic Daylight Equivalent Ratio

LM302N NITE

Fine-tuned spectrum for more relaxing moments

- 0.9W class mid power LED
- EMC package for high reliability
- Standard form factor for design flexibility (3.0mmx3.0mm)
- Patent registered for optimized spectrum

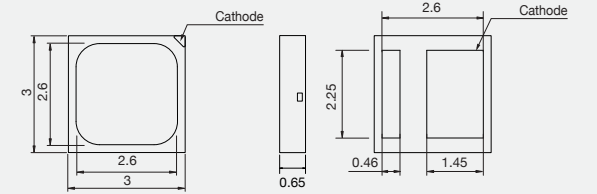
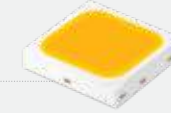

[150mA, 25°C]

CRI	CCT (K)	Part Number	Luminous Flux (lm)		M/P Ratio*	MDER**
			Bin	Range		
80+	1800	SPMWH3326FN5FBA☆S0	S0	80-95	0.20	0.18
	2200	SPMWH3326FN5FBY☆S0	S0	90-105	0.28	0.25
	2700	SPMWH3326FN5FBW☆S0	S0	95-110	0.37	0.34
	3000	SPMWH3326FN5FBV☆S0	S0	105-120	0.48	0.43
	3500	SPMWH3326FN5FBU☆S0	S0	110-125	0.56	0.51
	4000	SPMWH3326FN5FBT☆S0	S0	110-125	0.64	0.58

☆ ☆ can be "0" (MacAdam 5 step), "3" (MacAdam 3 step), "Y" (Kitting)

* M/P Ratio: Melanopic/Photopic Ratio

** MDER: Melanopic Daylight Equivalent Ratio



Full spectrum horticulture lighting that enriches both crop quality and output

- Designed to provide excellent cutting-edge performance (PPF, PPF/W) with outstanding resistance to heat, humidity, and chemicals
- Proven levels of performance and reliability to the market

LM301H



Mid-power white LED for horticulture lighting applications

- World's best efficacy
- Footprint: 3.0mm x 3.0mm

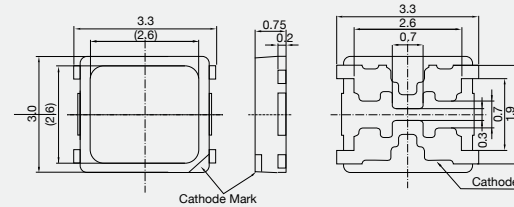

[65mA, 25°C, 5000K, CRI80+]

Color	Wavelength(nm)	Part Number	Flux Rank	PPF* Typ. (μmol/s)	PPF/W Typ. (μmol/J)
White	Full	SPMWH32AMH5XAP0SL	SL	0.56	3.10

* Photosynthetic Photon Flux

LM301H ONE

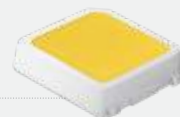

Mid-power white LED for horticulture lighting applications

- Optimized spectrum for leafy greens
- Footprint: 3.0mm x 3.0mm

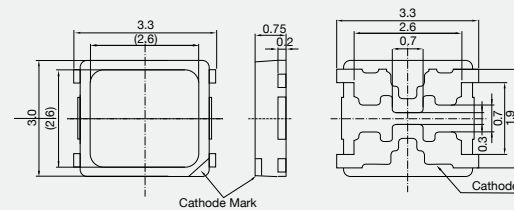

[65mA, 25°C, 3400K, CRI70+]

Color	Wavelength(nm)	Part Number	Flux Rank	PPF* Typ. (μmol/s)	PPF/W Typ. (μmol/J)
White	Full	SPMWH32AMH1XAH0S0	S0	0.49	2.75

* Photosynthetic Photon Flux

LM561H



Mid-power white LED for horticulture lighting applications

- Balanced performance/cost
- Footprint: 5.6mm x 3.0mm

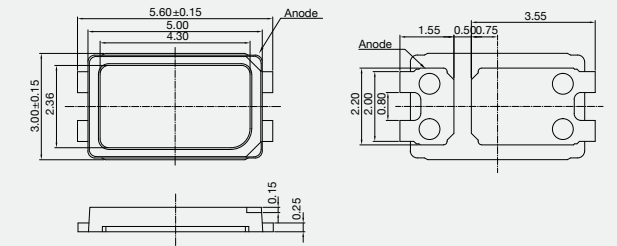

[65mA, 25°C, 5000K, CRI80+]

Color	Wavelength(nm)	Part Number	Flux Rank	PPF* Typ. (μmol/s)	PPF/W Typ. (μmol/J)
White	Full	SPMWH541MT5XAP0S6	S6	0.51	2.84

* Photosynthetic Photon Flux

LH241H



White CSP LED for horticulture lighting applications

- Compact design for small LES module
- Footprint: 2.4mm x 2.4mm

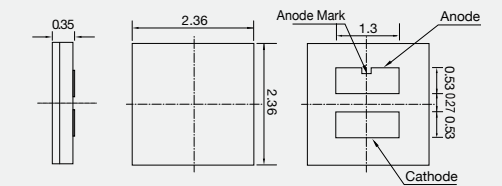

[350mA, 25°C, 5000K, CRI70+]

Color	Wavelength(nm)	Part Number	Flux Rank	PPF* Typ. (μmol/s)	PPF/W Typ. (μmol/J)
White	Full	SCP7RTF1HEH1RKP34E	R1	2.51	2.52

* Photosynthetic Photon Flux

LH281H



White CSP LED for horticulture lighting applications

- Compact design for small LES module
- Footprint: 2.8mm x 2.8mm

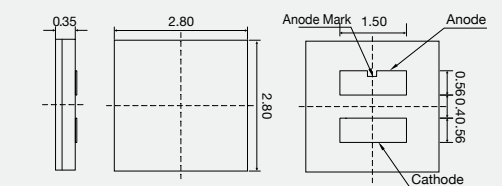

[350mA, 25°C, 5000K, CRI70+]

Color	Wavelength(nm)	Part Number	Flux Rank	PPF* Typ. (μmol/s)	PPF/W Typ. (μmol/J)
White	Full	SCP7RTJ5EH1RLQF6E	SB	2.59	2.65

* Photosynthetic Photon Flux

LH351H-B

High power white LED for horticulture lighting applications

- Industry-proven performance and reliability
- Footprint: 3.5mm x 3.5mm

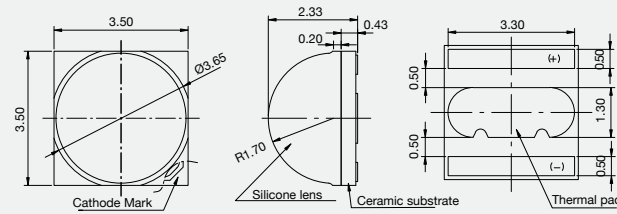
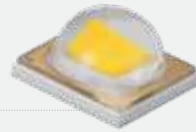

[350mA, 25°C, 5000K, CRI70+]

Color	Wavelength(nm)	Part Number	Flux Rank	PPF* Typ. (μmol/s)	PPF/W Typ. (μmol/J)
White	Full	SPHWH2L3D3HCD4RTQ2	Q1	2.48	2.51

* Photosynthetic Photon Flux

LH351H-C

High power white LED for horticulture lighting applications

- Industry-proven performance and reliability
- Footprint: 3.5mm x 3.5mm

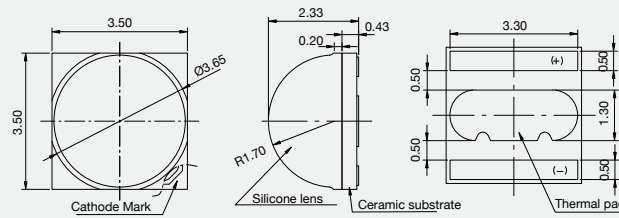
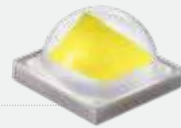

[350mA, 25°C, 5000K, CRI70+]

Color	Wavelength(nm)	Part Number	Flux Rank	PPF* Typ. (μmol/s)	PPF/W Typ. (μmol/J)
White	Full	SPHWHTL3D5HCE4RTQF	RB	2.56	2.60

* Photosynthetic Photon Flux

LH351H-D

High power white LED for horticulture lighting applications

- Industry-proven performance and reliability
- Footprint: 3.5mm x 3.5mm

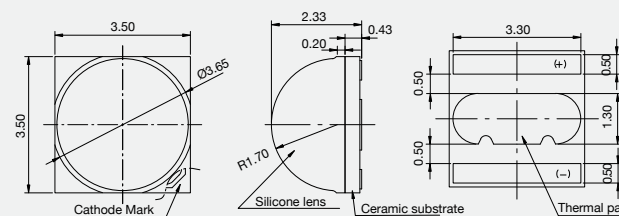
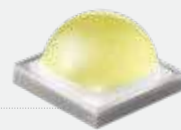

[350mA, 25°C, 5000K, CRI70+]

Color	Wavelength(nm)	Part Number	Flux Rank	PPF* Typ. (μmol/s)	PPF/W Typ. (μmol/J)
White	Full	SPHWHTL3DAHCF4RTY6	Y2	2.58	2.69

* Photosynthetic Photon Flux

LH351H Blue (450nm)

High power blue LED for horticulture lighting applications

- Peak wavelength: 450nm
- Footprint: 3.5mm x 3.5mm

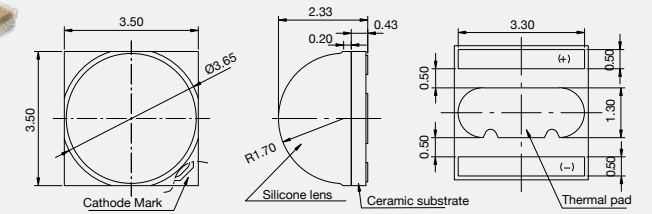

[350mA, 25°C]

Color	Wavelength (nm)	Part Number	Optical Power Typ. (mW)	PPF* Typ. (μmol/s)	PPF/W Typ. (μmol/J)
Blue	450	SPHBL1L3DH00L4A4B0	750	2.80	2.80

* Photosynthetic Photon Flux

LH351H Red (630nm)

High power red LED for horticulture lighting applications

- Peak wavelength: 630nm
- Footprint: 3.5mm x 3.5mm

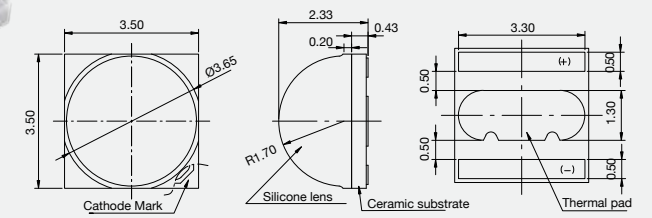

[350mA, 25°C]

Color	Wavelength (nm)	Part Number	Optical Power Typ. (mW)	PPF* Typ. (μmol/s)	PPF/W Typ. (μmol/J)
Red	630	SPHRD1L3DH02C8S4B7	300	1.57	2.14

* Photosynthetic Photon Flux

LH351H Deep Red (660nm)

High power deep red LED for horticulture lighting applications

- Peak wavelength: 660nm
- Footprint: 3.5mm x 3.5mm

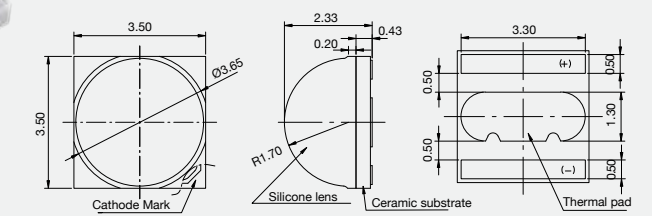
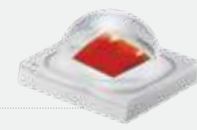

[350mA, 25°C]

Color	Wavelength (nm)	Part Number	Optical Power Typ. (mW)	PPF* Typ. (μmol/s)	PPF/W Typ. (μmol/J)
Deep Red	660	SPHRD1L3DH00A4R2D2	425	2.32	3.12
Deep Red	660	SPHRD2L3DH00D5W4M0	435	2.4	3.11

* Photosynthetic Photon Flux

LH351H Deep Red (660nm) V2

High power deep red LED for horticulture lighting applications

- Peak wavelength: 660nm
- Footprint: 3.5mm x 3.5mm

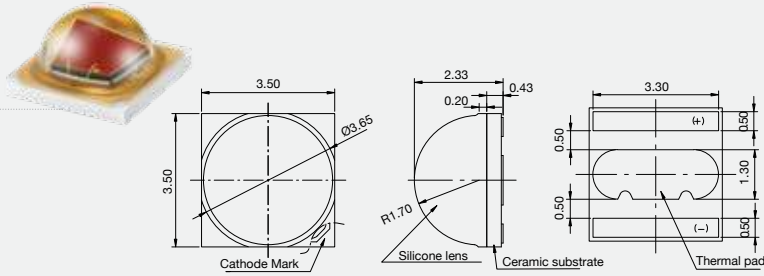

[350mA, 25°C]

Color	Wavelength (nm)	Part Number	Optical Power Typ. (mW)	BPF* Typ. (μmol/s)	BPF/W Typ. (μmol/J)
Deep Red	660	SPHRD2L3DH20E7W410	480	2.63	3.73

* Photosynthetic Photon Flux

LH351H Far Red (730nm)

High power far red LED for horticulture lighting applications

- Peak wavelength: 730nm
- Footprint: 3.5mm x 3.5mm

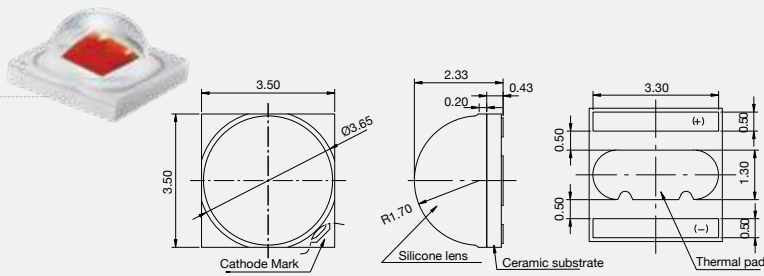

[350mA, 25°C]

Color	Wavelength (nm)	Part Number	Optical Power Typ. (mW)	BPF* Typ. (μmol/s)	BPF/W Typ. (μmol/J)
Far Red	730	SPHRD1L3DH01A844B0	330	1.96	2.91
Far Red	730	SPHRD2L3DH01A844B0	350	2.07	3.1

*Biologically-active Photon Flux

Horticulture LED Module



1ft



2ft

Type	Color	PPF* (μmol/s)	PPF/W** (μmol/J)	Luminous Flux (lm)	Power Consumption (W)	Input Voltage (V)	IF (mA)	Efficacy (lm/W)	CCT (K)	Tp (°C)	Model Name
1ft	White + Red	70.9	2.74	4110	25.8	21.5	1200	159	5390	25	SL-B8R5C9H1AWW
2ft		141.8		8220	51.7	43.1					SL-B8R5C9H2AWW

* Photosynthetic Photon Flux ** Photosynthetic Photon Efficacy

※ Optional conformal coating



Fine-tuned LEDs for color maximization

- Industry-leading light efficacies throughout various COB solutions
- Advanced object attractiveness

R-series

LC013R	LC016R	LC019R	LC026R	LC033R	LC040R

T-series

LC010T	LC020T	LC035T

R-series Fashion

Vividly enhanced colors, contrast and exceptional white light

Vivid White (in Gen 2)

Product	LES Size (mm)	CRI Min.	CCT	Color Rank	Part Number	T _j =85°C		Power, Current, Voltage	
						Luminous Flux Typ. (lm)	Luminous Efficacy Typ. (lm/W)	Typ.	Max
 LC013R Fashion Vivid White	9.8 13.5x13.5	90+	3000 (Below BBL)	MacAdam 3step	SPHWHAHND27YZVND2	1435	115	12.5W 360mA 34.6V	34.5W 920mA 37.5V
			3500 (Below BBL)	MacAdam 3step	SPHWHAHND27YZUND2	1494	120		
			4000 (Below BBL)	MacAdam 3step	SPHWHAHND27YZTND2	1541	124		
 LC016R Fashion Vivid White	14.5 19x19	90+	3000 (Below BBL)	MacAdam 3step	SPHWHAHND27YZVND2	1837	118	15.6W 450mA 34.6V	43.1W 1150mA 37.5V
			3500 (Below BBL)	MacAdam 3step	SPHWHAHND27YZUND2	1912	123		
			4000 (Below BBL)	MacAdam 3step	SPHWHAHND27YZTND2	1972	127		
 LC019R Fashion Vivid White	14.5 19x19	90+	3000 (Below BBL)	MacAdam 3step	SPHWHAHDF27YZVND2	2195	117	18.7W 540mA 34.6V	51.8W 1380mA 37.5V
			3500 (Below BBL)	MacAdam 3step	SPHWHAHDF27YZUND2	2284	122		
			4000 (Below BBL)	MacAdam 3step	SPHWHAHDF27YZTND2	2355	126		
 LC026R Fashion Vivid White	14.5 19x19	90+	3000 (Below BBL)	MacAdam 3step	SPHWHAHNG27YZVND2	2917	117	24.9W 720mA 34.6V	69W 1840mA 37.5V
			3500 (Below BBL)	MacAdam 3step	SPHWHAHNG27YZUND2	3036	122		
			4000 (Below BBL)	MacAdam 3step	SPHWHAHNG27YZTND2	3131	126		
 LC033R Fashion Vivid White	14.5 19x19	90+	3000 (Below BBL)	MacAdam 3step	SPHWHAHNH27YZVND2	3589	115	31.1W 900mA 34.6V	86.2W 2300mA 37.5V
			3500 (Below BBL)	MacAdam 3step	SPHWHAHNH27YZUND2	3735	120		
			4000 (Below BBL)	MacAdam 3step	SPHWHAHNH27YZTND2	3852	124		
 LC040R Fashion Vivid White	22 28x28	90+	3000 (Below BBL)	MacAdam 3step	SPHWHAHNK27YZVND2	4428	118	37.4W 1080mA 34.6V	103.5W 2760mA 37.5V
			3500 (Below BBL)	MacAdam 3step	SPHWHAHNK27YZUND2	4591	123		
			4000 (Below BBL)	MacAdam 3step	SPHWHAHNK27YZTND2	4745	127		

Vivid White (in Gen 2+)

Product	LES Size (mm)	CRI Min.	CCT	Color Rank	Part Number	T _j =85°C		Power, Current, Voltage	
						Luminous Flux Typ. (lm)	Luminous Efficacy Typ. (lm/W)	Typ.	Max
 LC013R Fashion Vivid White	9.8 13.5x13.5	90+	3000 (Below BBL)	MacAdam 3step	SPHWHAHND27YZVND2	1511	123	12.2W 360mA 34V	26.6W 720mA 34V
			3500 (Below BBL)	MacAdam 3step	SPHWHAHND27YZUND2	1526	125		
			4000 (Below BBL)	MacAdam 3step	SPHWHAHND27YZTND2	1622	133		
 LC016R Fashion Vivid White	14.5 19x19	90+	3000 (Below BBL)	MacAdam 3step	SPHWHAHND27YZVND2	1934	126	15.3W 450mA 34V	33.2W 900mA 34V
			3500 (Below BBL)	MacAdam 3step	SPHWHAHND27YZUND2	1953	128		
			4000 (Below BBL)	MacAdam 3step	SPHWHAHND27YZTND2	2078	136		
 LC019R Fashion Vivid White	14.5 19x19	90+	3000 (Below BBL)	MacAdam 3step	SPHWHAHDF27YZVND2	2310	126	18.4W 540mA 34V	39.9W 1080mA 34V
			3500 (Below BBL)	MacAdam 3step	SPHWHAHDF27YZUND2	2333	127		
			4000 (Below BBL)	MacAdam 3step	SPHWHAHDF27YZTND2	2479	135		
 LC026R Fashion Vivid White	14.5 19x19	90+	3000 (Below BBL)	MacAdam 3step	SPHWHAHNG27YZVND2	3071	125	24.5W 720mA 34V	53.1W 1440mA 34V
			3500 (Below BBL)	MacAdam 3step	SPHWHAHNG27YZUND2	3102	127		
			4000 (Below BBL)	MacAdam 3step	SPHWHAHNG27YZTND2	3296	135		
 LC033R Fashion Vivid White	14.5 19x19	90+	3000 (Below BBL)	MacAdam 3step	SPHWHAHNH27YZVND2	3778	123	30.6W 900mA 34V	66.4W 1800mA 34V
			3500 (Below BBL)	MacAdam 3step	SPHWHAHNH27YZUND2	3816	125		
			4000 (Below BBL)	MacAdam 3step	SPHWHAHNH27YZTND2	4055	133		
 LC040R Fashion Vivid White	22 28x28	90+	3000 (Below BBL)	MacAdam 3step	SPHWHAHNK27YZVND2	4590	125	36.7W 1080mA 34V	79.7W 2160mA 34V
			3500 (Below BBL)	MacAdam 3step	SPHWHAHNK27YZUND2	4536	124		
			4000 (Below BBL)	MacAdam 3step	SPHWHAHNK27YZTND2	4926	134		

Vivid White (in Gen 3+)

Product	LES Size (mm)	CRI Min.	CCT	Color Rank	Part Number	T _j =85°C		Power, Current, Voltage	
						Luminous Flux Typ. (lm)	Luminous Efficacy Typ. (lm/W)	Typ.	Max
 LC013R Fashion Vivid White	9.8 13.5x13.5	90+	3000 (Below BBL)	MacAdam 3step	SPHWAHDND27YZVNDC	1541	127	12.1W 360mA 33.7V	26.4W 720mA 33.7V
			3500 (Below BBL)	MacAdam 3step	SPHWAHDND27YZUNDC	1557	128		
			4000 (Below BBL)	MacAdam 3step	SPHWAHDND27YZTNDC	1654	136		
 LC016R Fashion Vivid White	14.5 19x19	90+	3000 (Below BBL)	MacAdam 3step	SPHWAHDNE27YZVNDC	1973	130	15.2W 450mA 33.7V	33W 900mA 33.7V
			3500 (Below BBL)	MacAdam 3step	SPHWAHDNE27YZUNDC	1992	131		
			4000 (Below BBL)	MacAdam 3step	SPHWAHDNE27YZTNDC	2117	140		
 LC019R Fashion Vivid White	14.5 19x19	90+	3000 (Below BBL)	MacAdam 3step	SPHWAHDNF27YZVNDC	2356	129	18.2W 540mA 33.7V	39.5W 1080mA 33.7V
			3500 (Below BBL)	MacAdam 3step	SPHWAHDNF27YZUNDC	2380	131		
			4000 (Below BBL)	MacAdam 3step	SPHWAHDNF27YZTNDC	2529	139		
 LC026R Fashion Vivid White	14.5 19x19	90+	3000 (Below BBL)	MacAdam 3step	SPHWAHDNG27YZVNDC	3132	129	24.3W 720mA 33.7V	52.7W 1440mA 33.7V
			3500 (Below BBL)	MacAdam 3step	SPHWAHDNG27YZUNDC	3164	130		
			4000 (Below BBL)	MacAdam 3step	SPHWAHDNG27YZTNDC	3362	139		
 LC033R Fashion Vivid White	14.5 19x19	90+	3000 (Below BBL)	MacAdam 3step	SPHWAHDNH27YZVNDC	3800	125	30.3W 900mA 33.7V	65.9W 1800mA 33.7V
			3500 (Below BBL)	MacAdam 3step	SPHWAHDNH27YZUNDC	3838	127		
			4000 (Below BBL)	MacAdam 3step	SPHWAHDNH27YZTNDC	4078	134		
 LC040R Fashion Vivid White	22 28x28	90+	3000 (Below BBL)	MacAdam 3step	SPHWAHDNK27YZVNDC	4755	131	36.4W 1080mA 33.7V	79.1W 2160mA 33.7V
			3500 (Below BBL)	MacAdam 3step	SPHWAHDNK27YZUNDC	4803	132		
			4000 (Below BBL)	MacAdam 3step	SPHWAHDNK27YZTNDC	5103	140		

Vivid Color

Product	LES Size (mm)	CCT	Color Rank	Part Number	T _j =85°C		Power, Current, Voltage		
					Luminous Flux Typ. (lm)	Luminous Efficacy Typ. (lm/W)	Typ.	Max	
 LC013R Fashion Vivid Color	9.8 13.5x13.5	3000 (Below BBL)	MacAdam 2step	SPHWAHDND2VYZV2D2	1334	107	12.5W 360mA 34.6V	34.5W 920mA 37.5V	
				MacAdam 3step					SPHWAHDND2VYZVVD2
				MacAdam 2step					SPHWAHDND2VYZA2D2
									MacAdam 3step
				MacAdam 2step					SPHWAHDND2VYZU2D2
									MacAdam 3step
 LC016R Fashion Vivid Color	14.5 19x19	3000 (Below BBL)	MacAdam 2step	SPHWAHDNE2VYZ2VD2	1745	112	15.6W 450mA 34.6V	43.1W 1150mA 37.5V	
				MacAdam 3step					SPHWAHDNE2VYZVVD2
				MacAdam 2step					SPHWAHDNE2VYZA2D2
									MacAdam 3step
				MacAdam 2step					SPHWAHDNE2VYZU2D2
									MacAdam 3step
 LC019R Fashion Vivid Color	14.5 19x19	3000 (Below BBL)	MacAdam 2step	SPHWAHDNF2VYZV2D2	2068	111	18.7W 540mA 34.6V	51.8W 1380mA 37.5V	
				MacAdam 3step					SPHWAHDNF2VYZVVD2
				MacAdam 2step					SPHWAHDNF2VYZA2D2
									MacAdam 3step
				MacAdam 2step					SPHWAHDNF2VYZU2D2
									MacAdam 3step
 LC019R Fashion Vivid Color	14.5 19x19	3500 (Below BBL)	MacAdam 2step	SPHWAHDNE2VYZT2D2	2160	116	22.2W 660mA 33.7V	58.5W 1740mA 37.5V	
				MacAdam 3step					SPHWAHDNE2VYZTVD2
				MacAdam 2step					SPHWAHDNE2VYZA2D2
									MacAdam 3step
				MacAdam 2step					SPHWAHDNE2VYZU2D2
									MacAdam 3step
 LC019R Fashion Vivid Color	14.5 19x19	4000 (Below BBL)	MacAdam 2step	SPHWAHDNE2VYZT2D2	2376	127	30.3W 900mA 33.7V	79.1W 2160mA 33.7V	
				MacAdam 3step					SPHWAHDNE2VYZTVD2
				MacAdam 2step					SPHWAHDNE2VYZA2D2
									MacAdam 3step
				MacAdam 2step					SPHWAHDNE2VYZU2D2
									MacAdam 3step

Product	LES Size (mm)	CCT	Color Rank	Part Number	T _j =85°C		Power, Current, Voltage	
					Luminous Flux Typ. (lm)	Luminous Efficacy Typ. (lm/W)	Typ.	Max
 LC026R Fashion Vivid Color	14.5 19x19	3000 (Below BBL)	MacAdam 2step	SPHWHAHNDG2VYZV2D2	2706	109	24.9W 720mA 34.6V	69W 1840mA 37.5V
			MacAdam 3step	SPHWHAHNDG2VYZVVD2				
		3300 (Below BBL)	MacAdam 2step	SPHWHAHNDG2VYZA2D2	2827	113		
			MacAdam 3step	SPHWHAHNDG2VYZAVD2				
		3500 (Below BBL)	MacAdam 2step	SPHWHAHNDG2VYZU2D2	2907	117		
			MacAdam 3step	SPHWHAHNDG2VYZUVD2				
		4000 (Below BBL)	MacAdam 2step	SPHWHAHNDG2VYZT2D2	3108	125		
			MacAdam 3step	SPHWHAHNDG2VYZTVD2				
 LC033R Fashion Vivid Color	14.5 19x19	3000 (Below BBL)	MacAdam 2step	SPHWHAHDNH2VYZV2D2	3339	107	31.1W 900mA 34.6V	86.2W 2300mA 37.5V
			MacAdam 3step	SPHWHAHDNH2VYZVVD2				
		3300 (Below BBL)	MacAdam 2step	SPHWHAHDNH2VYZA2D2	3488	112		
			MacAdam 3step	SPHWHAHDNH2VYZAVD2				
		3500 (Below BBL)	MacAdam 2step	SPHWHAHDNH2VYZU2D2	3588	115		
			MacAdam 3step	SPHWHAHDNH2VYZUVD2				
		4000 (Below BBL)	MacAdam 2step	SPHWHAHDNH2VYZT2D2	3836	123		
			MacAdam 3step	SPHWHAHDNH2VYZTVD2				
 LC040R Fashion Vivid Color	22 28x28	3000 (Below BBL)	MacAdam 2step	SPHWHAHDNK2VYZV2D2	4150	111	37.4W 1080mA 34.6V	103.5W 2760mA 37.5V
			MacAdam 3step	SPHWHAHDNK2VYZVVD2				
		3300 (Below BBL)	MacAdam 2step	SPHWHAHDNK2VYZA2D2	4335	116		
			MacAdam 3step	SPHWHAHDNK2VYZAVD2				
		3500 (Below BBL)	MacAdam 2step	SPHWHAHDNK2VYZU2D2	4459	119		
			MacAdam 3step	SPHWHAHDNK2VYZUVD2				
		4000 (Below BBL)	MacAdam 2step	SPHWHAHDNK2VYZT2D2	4768	128		
			MacAdam 3step	SPHWHAHDNK2VYZTVD2				

R-series Meat

Special spectrum enhanced vividness for Meat

Product	LES Size (mm)	Color Rank	Part Number	T _j =85°C		Power, Current, Voltage	
				Luminous Flux Typ. (lm)	Luminous Efficacy Typ. (lm/W)	Typ.	Max
 LC013R Meat	9.8 13.5x13.5	MacAdam 2step	SPHWHAHND2VYZTSD2	914	73	12.5W 360mA 34.6V	34.5W 920mA 37.5V
 LC016R Meat	14.5 19x19	MacAdam 2step	SPHWHAHND2VYZTSD2	1188	76	15.6W 450mA 34.6V	43.1W 1150mA 37.5V
 LC019R Meat	14.5 19x19	MacAdam 2step	SPHWHAHDF2VYZTSD2	1412	76	18.7W 540mA 34.6V	51.8W 1380mA 37.5V
 LC026R Meat	14.5 19x19	MacAdam 2step	SPHWHAHNDG2VYZTSD2	1845	74	24.9W 720mA 34.6V	69W 1840mA 37.5V
 LC033R Meat	14.5 19x19	MacAda 2step	SPHWHAHDNH2VYZTSD2	2284	73	31.1W 900mA 34.6V	86.2W 2300mA 37.5V



R-series Vegetable

Special spectrum enhanced vividness for Vegetable

Product	LES Size (mm)	Color Rank	Part Number	T _j =85°C		Power, Current, Voltage	
				Luminous Flux Typ. (lm)	Luminous Efficacy Typ. (lm/W)	Typ.	Max
 LC013R Vegetable	9.8 13.5x13.5	MacAdam 2step	SPHWAHDND2VYZRSD2	1188	95	12.5W 360mA 34.6V	34.5W 920mA 37.5V
 LC016R Vegetable	14.5 19x19	MacAdam 2step	SPHWAHDNE2VYZRSD2	1544	99	15.6W 450mA 34.6V	43.1W 1150mA 37.5V
 LC019R Vegetable	14.5 19x19	MacAdam 2step	SPHWAHDNF2VYZRSD2	1835	98	18.7W 540mA 34.6V	51.8W 1380mA 37.5V
 LC026R Vegetable	14.5 19x19	MacAdam 2step	SPHWAHDNG2VYZRSD2	2399	96	24.9W 720mA 34.6V	69W 1840mA 37.5V
 LC033R Vegetable	14.5 19x19	MacAda 2step	SPHWAHDNH2VYZRSD2	2969	95	31.1W 900mA 34.6V	86.2W 2300mA 37.5V

T-series

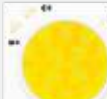
Wide CCT tuning (2700K~6500K) through 2-channel (warm & cool white) current driving

Product	LES Size (mm)	CRI Min.	CCT (K)	Color Rank	Part Number	T _j =85°C		Power, Current, Voltage	
						Luminous Flux Typ. (lm)	Luminous Efficacy Typ. (lm/W)	Typ.	Max
 LC010T	9.8 19x19	80+	2700	MacAdam 3step	SPHWAHDNC25YZWPT1	1190	120	9.8W 280mA 35.0V	15W 400mA 36.0V
			6500	MacAdam 5step		1352	136		
			2700	MacAdam 3step	SPHWAHDNC27YZWPT1	988	99		
			5000	MacAdam 5step		1149	116		
 LC020T	13 19x19	80+	2700	MacAdam 3step	SPHWAHDNF25YZWPT1	2355	118	19.6W 560mA 35.0V	30W 800mA 36.0V
			6500	MacAdam 5step		2676	135		
			2700	MacAdam 3step	SPHWAHDNF27YZWPT1	1956	98		
			5000	MacAdam 5step		2275	114		
 LC035T	22 28x28	80+	2700	MacAdam 3step	SPHWAHDNH25YZWPT1	4405	127	34.3W 980mA 35.0V	45W 1250mA 36.0V
			6500	MacAdam 5step		5006	144		
			2700	MacAdam 3step	SPHWAHDNH27YZWPT1	3660	105		
			5000	MacAdam 5step		4255	122		



High power LEDs with TLCI 90+, optimized for sports lighting applications

- Adapted a technology combining chip and phosphor
- A lineup offering long lifespan and low thermal resistance

LH181B



Compact form factor for high density sports lighting

- 3W, 2.75V high power LED
- Beam angle: 120°
- Thermal resistance: 2.0K/W
- Compact footprint: 2.36mm x 2.36mm

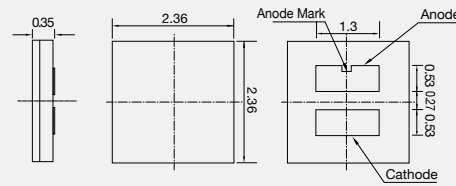

[350mA, 85°C]

CRI	CCT (K)	TLCI	Part Number	Luminous Flux (lm)		
				Bin	Min.	Max.
70+	2700	-	SCP7WTF1HEL1W◇M34E	M1, N1, P1	140	170
	3000	-	SCP7VTF1HEL1V◇N34E	N1, P1, Q1	150	180
	3500	-	SCP7UTF1HEL1U◇N34E	N1, P1, Q1	150	180
	4000	-	SCP7TF1HEL1T◇P34E	P1, Q1, R1	160	190
	5000	-	SCP7RTF1HEL1R◇P34E	P1, Q1, R1	160	190
	5700	-	SCP7QTF1HEL1Q◇P34E	P1, Q1, R1	160	190
	6500	-	SCP7PTF1HEL1P◇N34E	N1, P1, Q1	150	180
80+	2200	-	SCP8YTF1HEL1Y◇H34E	H1, J1, K1	110	140
	2700	-	SCP8WTF1HEL1W◇K34E	K1, M1, N1	130	160
	3000	-	SCP8VTF1HEL1V◇K34E	K1, M1, N1	130	160
	3500	-	SCP8UTF1HEL1U◇M34E	M1, N1, P1	140	170
	4000	-	SCP8TF1HEL1T◇M34E	M1, N1, P1	140	170
	5000	-	SCP8RTF1HEL1R◇N34E	N1, P1, Q1	150	180
	5700	-	SCP8QTF1HEL1Q◇N34E	N1, P1, Q1	150	180
90+	2700	-	SCP9WTF1HEL1W◇G34E	G1, H1, J1	100	130
	3000	-	SCP9VTF1HEL1V◇G34E	G1, H1, J1	100	130
	3500	-	SCP9UTF1HEL1U◇H34E	H1, J1, K1	110	140
	4000	-	SCP9TF1HEL1T◇H34E	H1, J1, K1	110	140
	5000	-	SCP9RTF1HEL1R◇H34E	H1, J1, K1	110	140

* "◇" can be "K" (MacAdam 5-step ellipse bin), "U" (MacAdam 3-step ellipse bin) of the color binning

LH231B



Compact form factor for high density sports lighting

- 5W, 2.85V high power LED
- Beam angle: 120°
- Thermal resistance: 2.0K/W
- Compact footprint: 2.8mm x 2.8mm

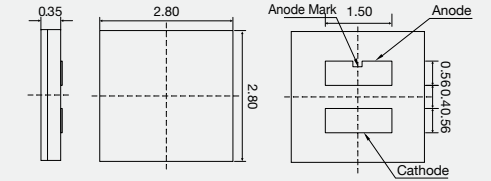

[700mA, 85°C]

CRI	CCT (K)	TLCI	Part Number	Luminous Flux (lm)		
				Bin	Min.	Max.
70+	2700	-	SCP7WTJ5HEL1W☆MF6E	MB, NB, PB	250	310
	3000	-	SCP7VTJ5HEL1V☆NF6E	NB, PB, QB	270	330
	3500	-	SCP7UTJ5HEL1U☆PF6E	PB, QB, RB	290	350
	4000	-	SCP7TTJ5HEL1T☆QF6E	QB, RB, SB	310	370
	5000	-	SCP7RTJ5HEL1R☆QF6E	QB, RB, SB	310	370
	5700	-	SCP7QTJ5HEL1Q☆QF6E	QB, RB, SB	310	370
	6500	-	SCP7PTJ5HEL1P☆PF6E	PB, QB, RB	290	350
80+	2700	-	SCP8WTJ5HEL1W☆MF6E	MB, NB, PB	250	310
	3000	-	SCP8VTJ5HEL1V☆MF6E	MB, NB, PB	250	310
	3500	-	SCP8UTJ5HEL1U☆NF6E	NB, PB, QB	270	330
	4000	-	SCP8TTJ5HEL1T☆NF6E	NB, PB, QB	270	330
	5000	-	SCP8RTJ5HEL1R☆PF6E	PB, QB, RB	290	350
	5700	-	SCP8QTJ5HEL1Q☆NF6E	NB, PB, QB	270	330
	6500	-	SCP8PTJ5HEL1P☆NF6E	NB, PB, QB	270	330
90+	2700	-	SCP9WTJ5HEL1W☆HF6E	HB, JB, KB	190	250
	3000	-	SCP9VTJ5HEL1V☆HF6E	HB, JB, KB	190	250
	3500	-	SCP9UTJ5HEL1U☆JF6E	JB, KB, MB	210	270
	4000	-	SCP9TTJ5HEL1T☆JF6E	JB, KB, MB	210	270

* "☆" can be "L" (MacAdam 5-step ellipse bin), "U" (MacAdam 3-step ellipse bin) of the color binning

LH351B

Cost effective for sports lighting applications

- 3W, 2.7V high power LED
- Beam angle: 120°
- Thermal resistance: 4.2K/W
- Footprint: 3.5mm x 3.5mm

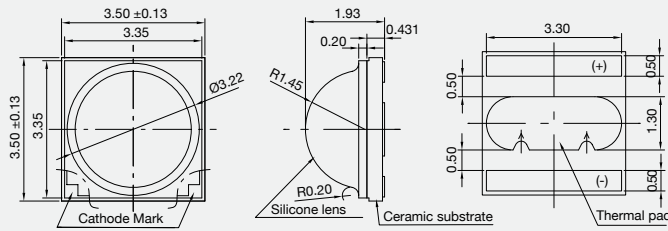

[350mA, 85°C]

CRI	CCT (K)	TLCI	Part Number	Luminous Flux (lm)			
				Bin	Min.	Max.	
70+	2200	-	SPHWH2L3D30CD4Y0K3	K1, M1, N1	130	160	
			SPHWH2L3D30CD4W0K3	K1, M1, N1	130	160	
	2700	-	SPHWH2L3D30CD4W0M3	M1, N1, P1	140	170	
			SPHWH2L3D30CD4W0N3	N1, P1, Q1	150	180	
	3000	-	SPHWH2L3D30CD4V0M3	M1, N1, P1	140	170	
			SPHWH2L3D30CD4V0N3	N1, P1, Q1	150	180	
	3500	-	SPHWH2L3D30CD4U0K3	K1, M1, N1	130	160	
			SPHWH2L3D30CD4U0M3	M1, N1, P1	140	170	
			SPHWH2L3D30CD4U0N3	N1, P1, Q1	150	180	
	4000	-	SPHWH2L3D30CD4T0N3	N1, P1, Q1	150	180	
			SPHWH2L3D30CD4T0P3	P1, Q1, R1	160	190	
			SPHWH2L3D30CD4T0Q2	Q1, R1	170	180	
	5000	-	SPHWH2L3D30CD4T0Q3	Q1, R1, S1	170	200	
			SPHWH2L3D30CD4RTM3	M1, N1, P1	140	170	
			SPHWH2L3D30CD4RTN3	N1, P1, Q1	150	180	
	5700	-	SPHWH2L3D30CD4RTP3	P1, Q1, R1	160	190	
			SPHWH2L3D30CD4RTQ2	Q1, R1	170	190	
			SPHWH2L3D30CD4R0Q3	Q1, R1, S1	170	200	
	6500	-	SPHWH2L3D30CD4QTN3	N1, P1, Q1	150	180	
			SPHWH2L3D30CD4QTP3	P1, Q1, R1	160	190	
			SPHWH2L3D30CD4Q0Q2	Q1, R1	170	190	
	80+	2200	-	SPHWH2L3D30ED4Y0G3	G1, H1, J1	100	130
				SPHWH2L3D30ED4W0J3	J1, K1, M1	120	150
		2700	-	SPHWH2L3D30ED4W0K3	K1, M1, N1	130	160
SPHWH2L3D30ED4V0J3				J1, K1, M1	120	150	
3000		-	SPHWH2L3D30ED4V0K3	K1, M1, N1	130	160	
			SPHWH2L3D30ED4V0M3	M1, N1, P1	140	170	
3500		-	SPHWH2L3D30ED4U0K3	K1, M1, N1	130	160	
			SPHWH2L3D30ED4U0M3	M1, N1, P1	140	170	
4000		-	SPHWH2L3D30ED4T0K3	K1, M1, N1	130	160	
			SPHWH2L3D30ED4T0M3	M1, N1, P1	140	170	
			SPHWH2L3D30ED4RTM3	M1, N1, P1	140	170	
5000		-	SPHWH2L3D30ED4RTN3	N1, P1, Q1	150	180	
			SPHWH2L3D30ED4QTM3	M1, N1, P1	140	170	
			SPHWH2L3D30ED4PQM3	M1, N1, P1	140	170	
6000		-	SPHWH2L3D30ED4PQK3	K1, M1, N1	130	160	
			SPHWH2L3D30ED4PQM3	M1, N1, P1	140	170	
			SPHWH2L3D30ED4PTK3	K1, M1, N1	130	160	
6500		-	SPHWH2L3D30ED4PTM3	M1, N1, P1	140	170	
			SPHWH2L3D30GD4W0F3	F1, G1, H1	90	120	
			SPHWH2L3D30GD4W0G3	G1, H1, J1	100	130	
90+		2700	-	SPHWH2L3D30GD4V0G3	G1, H1, J1	100	130
				SPHWH2L3D30GD4V0H3	H1, J1, K1	110	140
		3000	-	SPHWH2L3D30GD4U0G3	G1, H1, J1	100	130
				SPHWH2L3D30GD4U0H3	H1, J1, K1	110	140
	3500	-	SPHWH2L3D30GD4T0J3	J1, K1, M1	120	150	
			SPHWH2L3D30GD4T0K3	K1, M1, N1	130	160	

LH351C

High performance suitable for sports lighting applications

- 5W, 2.85V high power LED
- Beam angle: 128°
- Thermal resistance: 3.0K/W
- Footprint: 3.5mm x 3.5mm

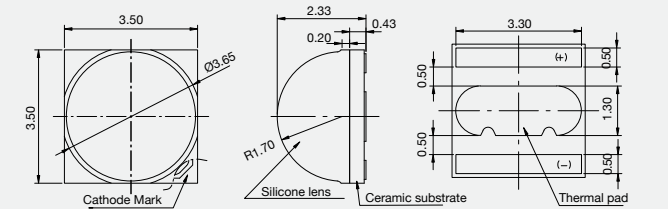
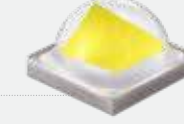

[700mA, 85°C]

CRI	CCT (K)	TLCI	Part Number	Luminous Flux (lm)			
				Bin	Min.	Max.	
70+	2200	-	SPHWHTL3D50CE4Y0MF	MB, NB, PB	250	310	
			SPHWHTL3D50CE4W0MF	MB, NB, PB	250	310	
	2700	-	SPHWHTL3D50CE4W0NF	NB, PB, QB	270	330	
			SPHWHTL3D50CE4V0NF	NB, PB, QB	270	330	
	3000	-	SPHWHTL3D50CE4V0PF	PB, QB, RB	290	350	
			SPHWHTL3D50CE4V0QF	QB, RB, SB	310	370	
	3500	-	SPHWHTL3D50CE4U0PF	PB, QB, RB	290	350	
			SPHWHTL3D50CE4U0QF	QB, RB, SB	310	370	
			SPHWHTL3D50CE4T0PF	PB, QB, RB	290	350	
	4000	-	SPHWHTL3D50CE4T0QF	QB, RB, SB	310	370	
			SPHWHTL3D50CE4T0RF	RB, SB, TB	330	390	
			SPHWHTL3D50CE4R0PF	PB, QB, RB	290	350	
	5000	-	SPHWHTL3D50CE4R0QF	QB, RB, SB	310	370	
			SPHWHTL3D50CE4R0RF	RB, SB, TB	330	390	
			SPHWHTL3D50CE4Q0PF	PB, QB, RB	310	370	
	5700	-	SPHWHTL3D50CE4Q0QF	QB, RB, SB	310	370	
			SPHWHTL3D50CE4Q0RF	RB, SB, TB	330	390	
			SPHWHTL3D50CE4P0PF	PB, QB, RB	290	350	
	6500	-	SPHWHTL3D50CE4PTQF	QB, RB, SB	310	370	
			SPHWHTL3D50DE4V0PF	PB, QB, RB	290	350	
			SPHWHTL3D50DE4U0PF	PB, QB, RB	290	350	
	75+	4000	-	SPHWHTL3D50DE4T0PF	PB, QB, RB	290	350
				SPHWHTL3D50DE4RTPF	PB, QB, RB	290	350
		5000	-	SPHWHTL3D50DE4RTQF	QB, RB, SB	310	370
SPHWHTL3D50DE4QTQF	PB, QB, RB			290	350		
5700	-	SPHWHTL3D50DE4QTQF	QB, RB, SB	310	370		
		SPHWHTL3D50EE4W0MF	MB, NB, PB	250	310		
		SPHWHTL3D50EE4W0NF	NB, PB, QB	270	330		
80+	3000	-	SPHWHTL3D50EE4V0NF	NB, PB, QB	270	330	
			SPHWHTL3D50EE4U0NF	NB, PB, QB	270	330	
	4000	-	SPHWHTL3D50EE4T0MF	MB, NB, PB	250	310	
SPHWHTL3D50EE4T0NF			NB, PB, QB	270	330		
SPHWHTL3D50EE4RTNF			NB, PB, QB	270	330		
5000	-	SPHWHTL3D50EE4RTPF	PB, QB, RB	290	350		
		SPHWHTL3D50EE4QTNF	NB, PB, QB	270	330		
		SPHWHTL3D50EE4QTQF	PB, QB, RB	290	350		
5700	-	SPHWHTL3D50GE4W0HF	HB, JB, KB	190	250		
		SPHWHTL3D50GE4W0JF	JB, KB, MB	210	270		
		SPHWHTL3D50GE4V0JF	JB, KB, MB	210	270		
90+	2700	-	SPHWHTL3D50GE4U0JF	JB, KB, MB	210	270	
			SPHWHTL3D50GE4U0KF	KB, MB, NB	230	290	
	4000	-	SPHWHTL3D50GE4T0JF	JB, KB, MB	210	270	
SPHWHTL3D50GE4T0KF			KB, MB, NB	230	290		
SPHWHTL3D50GE4RTKF			KB, MB, NB	230	290		
5000	-	SPHWHTL3D50GE4RTMF	MB, NB, PB	250	310		
		SPHWHTL3D50GE4QTKF	KB, MB, NB	230	290		
		SPHWHTL3D50GE4QTMF	MB, NB, PB	250	310		
5700	90+	-	SPHWHTL3D50TV4QTKF	KB, MB, NB	230	290	

LH351D

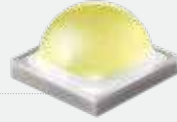

Best solution for high lumen output: street & sports lighting applications

- 10W, 2.99V high power LED
- Beam angle: 128°
- Thermal resistance: 2.2K/W
- Footprint: 3.5mm x 3.5mm

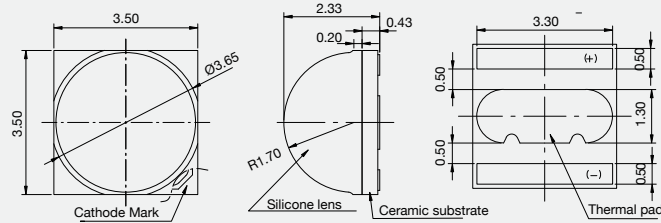

[1050mA, 85°C]

CRI	CCT (K)	TLCI	Part Number	Luminous Flux (lm)		
				Bin	Min.	Max.
70+	2700	-	SPHWHTL3DA0CF4W0S6	S2, T2, U2	380	420
			SPHWHTL3DA0CF4W0T6	T2, U2, V2	400	440
	3000	-	SPHWHTL3DA0CF4V0V6	V2, W2, Y2	440	480
			SPHWHTL3DA0CF4V0W6	W2, Y2, Z2	460	500
	3500	-	SPHWHTL3DA0CF4U0V6	V2, W2, Y2	440	480
			SPHWHTL3DA0CF4U0W6	W2, Y2, Z2	460	500
			SPHWHTL3DA0CF4U0Y6	Y2, Z2, 12	480	520
			SPHWHTL3DA0CF4T0W6	W2, Y2, Z2	460	520
	4000	-	SPHWHTL3DA0CF4T0Y6	Y2, Z2, 12	480	540
			SPHWHTL3DA0CF4RTW6	W2, Y2, Z2	460	500
			SPHWHTL3DA0CF4RTY6	Y2, Z2, 12	480	520
	5000	-	SPHWHTL3DA0CF4RTZ6	Z2, 12, 22	500	540
			SPHWHTL3DA0CF4QTV6	V2, W2, Y2	440	480
			SPHWHTL3DA0CF4QTW6	W2, Y2, Z2	460	500
	5700	-	SPHWHTL3DA0CF4QTY6	Y2, Z2, 12	480	520
			SPHWHTL3DA0CF4PTW6	W2, Y2, Z2	460	500
			SPHWHTL3DA0CF4PTY6	Y2, Z2, 12	480	520

CRI	CCT (K)	TLCI	Part Number	Luminous Flux (lm)		
				Bin	Min.	Max.
80+	2700	-	SPHWHTL3DA0EF4W0Q6	Q2, R2, S2	340	380
			SPHWHTL3DA0EF4W0R6	R2, S2, T2	360	400
	3000	-	SPHWHTL3DA0EF4V0R6	R2, S2, T2	360	400
			SPHWHTL3DA0EF4U0R6	R2, S2, T2	360	400
	3500	-	SPHWHTL3DA0EF4U0S6	S2, T2, U2	380	420
			SPHWHTL3DA0EF4T0S6	S2, T2, U2	380	420
	4000	-	SPHWHTL3DA0EF4T0T6	T2, U2, V2	400	440
			SPHWHTL3DA0EF4RTS6	S2, T2, U2	380	420
			SPHWHTL3DA0EF4RTT6	T2, U2, V2	400	440
	5000	-	SPHWHTL3DA0EF4RTU6	U2, V2, W2	420	460
			SPHWHTL3DA0EF4QRT6	T2, U2, V2	400	440
			SPHWHTL3DA0EF4QRU6	U2, V2, W2	420	460
	5300	-	SPHWHTL3DA0EF4QTT6	T2, U2, V2	400	440
			SPHWHTL3DA0EF4QTU6	U2, V2, W2	420	460
			SPHWHTL3DA0EF4PQT6	T2, U2, V2	400	440
	5700	-	SPHWHTL3DA0EF4PQU6	U2, V2, W2	420	460
			SPHWHTL3DA0EF4PTT6	T2, U2, V2	400	440
			SPHWHTL3DA0EF4PTU6	U2, V2, W2	420	460
90+	2700	-	SPHWHTL3DA0GF4W0M6	M2, N2, P2	280	320
			SPHWHTL3DA0GF4W0N6	N2, P2, Q2	300	340
	3000	-	SPHWHTL3DA0GF4V0N6	N2, P2, Q2	300	340
			SPHWHTL3DA0GF4V0P6	P2, Q2, R2	320	360
	3500	-	SPHWHTL3DA0GF4U0N6	N2, P2, Q2	300	340
			SPHWHTL3DA0GF4U0P6	P2, Q2, R2	320	360
	4000	-	SPHWHTL3DA0GF4T0P6	P2, Q2, R2	320	360
			SPHWHTL3DA0GF4T0Q6	Q2, R2, S2	340	380
	5000	-	SPHWHTL3DA0GF4RTR6	R2, S2, T2	360	400
			SPHWHTL3DA0GF4RTS6	S2, T2, U2	380	420
	6000	-	SPHWHTL3DA0GF4PQR6	R2, S2, T2	360	400
			SPHWHTL3DA0GF4PQS6	S2, T2, U2	380	420
5700	90+	-	SPHWHTL3DA0TV4QTS6	S2, T2, U2	380	420