



### SPECIFICATIONS

Model	Max Torque	Reverse Torque	Damping Direction
FYT-H2-104	10Nm (100kgfcm)	—	Both directions

Max Angle	Operating Temperature	Weight	Body and Cap Material	Rotor (Shaft) Material	Oil Type
105°	-5 ~ 50°C	235±10g	Zinc die-cast (ZDC)	S25C	Silicone Oil

Note) Measured at 23°C ± 2°C The FYT/N-H2 series has shorter shaft length

### DAMPING CHARACTERISTICS

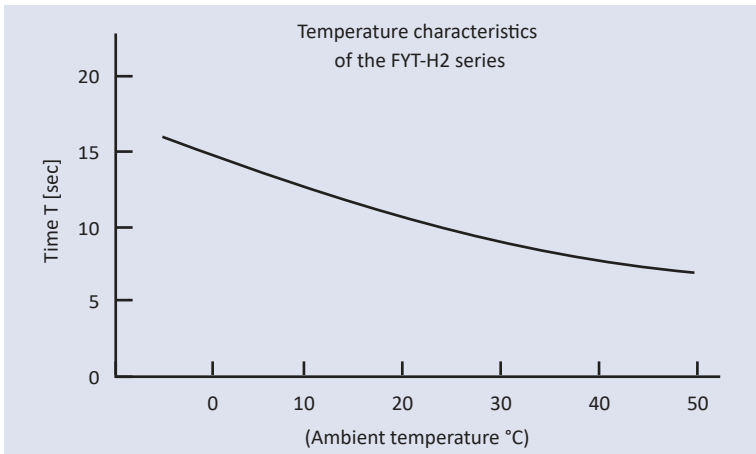

■ Damper characteristics vary according to the ambient temperature. In general, the damper characteristics become weaker as the temperature increases, and become stronger as the temperature decreases. This is because the viscosity of the oil inside the damper varies according to the temperature. When the temperature returns to normal, the damper characteristics will return to normal as well. The changes in the time it takes for the lid to close are shown in the graph to the left.

### OPTIONAL PART

#### Rotating Shaft Flange ROP-010H1

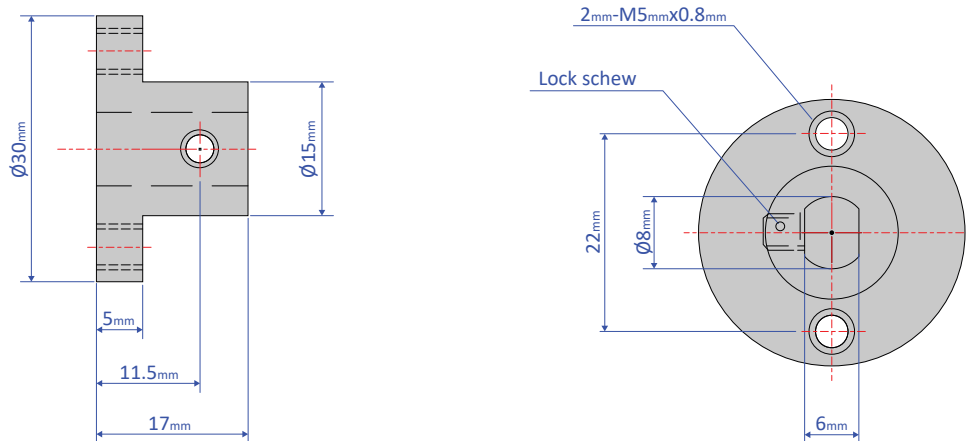

## HOW TO USE THE DAMPER

■ The uni-directional FYT-H2 is designed to generate a large torque just before a lid closing from a vertical position, as shown in Diagram A, comes to a full closure. When a lid is closed from a horizontal position, as shown in Diagram B, a strong torque is generated just before the lid is fully closed, causing the lid to not close properly. Torque is generated in both clockwise and counterclockwise directions in the FYT-H1(H2) series. Unlike the FYN-H1(H2) series, it does not have a fixed orifice for adjusting torque. Therefore, torque remains constant at any angle.

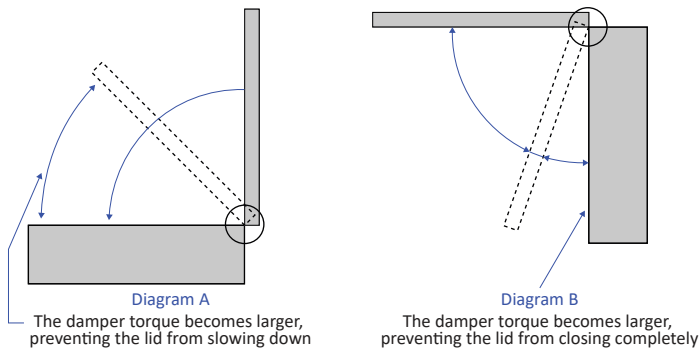

The angle in which the damper torque becomes large can be customized by modifying the inside orifice

■ When using a damper on a lid, such as the one shown in the diagram, use the following selection calculation to determine the damper torque.

Example)

Lid mass  $M$  : 5kg

Lid dimensions  $L$  : 0.4m

Gravity Center Position : Assumed as  $\frac{L}{2}$

$$\text{Load torque} : T = 5 \times 9.8 \times 0.4 \div 2 = 9.8 \text{ N}\cdot\text{m}$$

Based on the above calculation, FYN-H1-\*104 is selected.

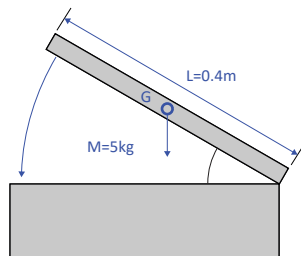

■ When connecting the rotating shaft to other parts, please ensure a tight fit between them. Without a tight fit, the lid will not slow down properly when closing. The corresponding dimensions for fixing the rotating shaft and the main body are as follows.

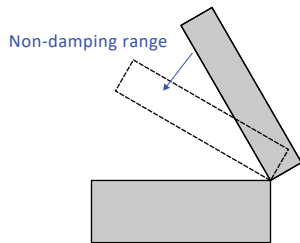
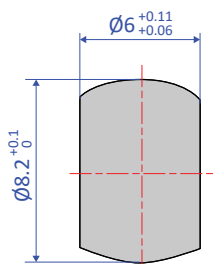

Recommended dimensions for mounting a rotating shaft

■ The damper's working angle is 105°, as shown below. Rotating the damper beyond this angle will cause damage to the damper. Please ensure that an external stopper is in place. The working angle is based on the width across flat for fixing, located towards the rear end of the main body. The position where the rotation is complete is at 90° with respect to the width across flat.

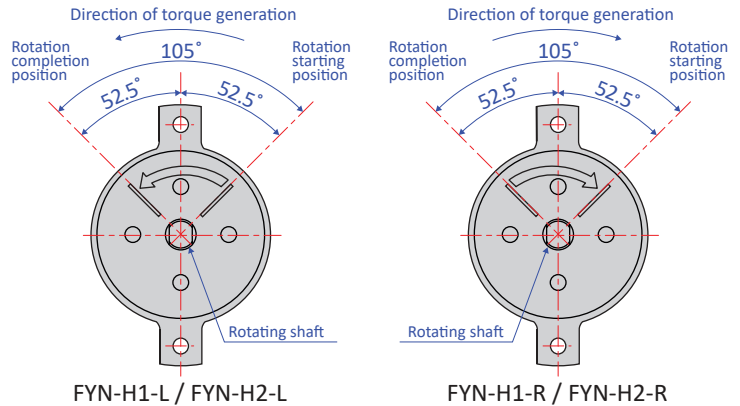

■ How to adjust the damper

- 1) In the FYT-H1 (H2) and FYN-H1 (H2) series, the amount of generated torque can be adjusted with the adjustment knob located towards the rear of the main body. Insert a screwdriver in the minus groove to turn.
- 2) Turn the adjustment knob in the H direction to increase torque.
- 3) Turn the adjustment knob in the L direction to reduce torque.
- 4) Do not turn the adjustment knob more than 360°. Turning the knob more than 360° causes the adjustment shaft to slip out, resulting in oil leakage.
- 5) Once the adjustment is complete, secure with a lock screw. Using the damper without securing it may result in fluctuating torque.

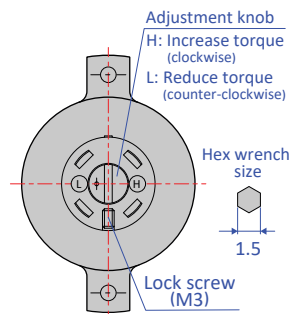

The direction in which torque is generated varies according to the model. Please select the appropriate model for your purpose

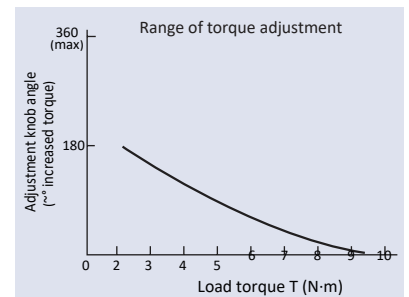

Please refer to the graph above for the relationship between torque and the adjustment knob