

Features

- Single (EL2186C) and dual (EL2286C) topologies
- 3mA supply current (per amplifier)
- 250MHz -3dB bandwidth
- Low cost
- Fast disable
- Powers down to 0mA
- Single- and dual-supply operation down to $\pm 1.5V$
- 0.05%/0.05° diff. gain/diff. phase into 150 Ω
- 1200V/ μs slew rate
- Large output drive current: 100mA (EL2186C) 55mA (EL2286C)
- Also available without disable in single (EL2180C), dual (EL2280C) and quad (EL2480C)
- Lower power EL2170C/EL2176C family also available (1mA/70MHz) in single, dual and quad

Applications

- Low power/battery applications
- HDSL amplifiers
- Video amplifiers
- Cable drivers
- RGB amplifiers
- Test equipment amplifiers
- Current to voltage converters

Ordering Information

Part No.	Package	Tape & Reel	Outline #
EL2186CN	PDIP-8	-	MDP0031
EL2186CS	SO-8	-	MDP0027
EL2186CS-T7	SO-8	7 in	MDP0027
EL2186CS-T13	SO-8	13 in	MDP0027
EL2286CN	PDIP-14	-	MDP0031
EL2286CS	SO-14	-	MDP0027
EL2286CS-T7	SO-14	7 in	MDP0027
EL2286CS-T13	SO-14	13 in	MDP0027

General Description

The EL2186C/EL2286C are single/dual current-feedback operational amplifiers which achieve a -3dB bandwidth of 250MHz at a gain of +1 while consuming only 3mA of supply current per amplifier. They will operate with dual supplies ranging from $\pm 1.5V$ to $\pm 6V$, or from single supplies ranging from +3V to +12V. The EL2186C/EL2286C also include a disable/power-down feature which reduces current consumption to 0mA while placing the amplifier output in a high impedance state. In spite of its low supply current, the EL2286C can output 55mA while swinging to $\pm 4V$ on $\pm 5V$ supplies. The EL2186C can output 100mA with similar output swings. These attributes make the EL2186C/EL2286C excellent choices for low power and/or low voltage cable-driver, HDSL, or RGB applications.

For Single, Dual and Quad applications without disable, consider the EL2180C (8-Pin Single), EL2280C (8-Pin Dual) or EL2480C (14-Pin Quad). For lower power applications where speed is still a concern, consider the EL2170C/EL2176C family which also comes in similar Single, Dual and Quad configurations. The EL2170C/EL2176C family provides a -3dB bandwidth of 70MHz while consuming 1mA of supply current per amplifier.

Connection Diagrams

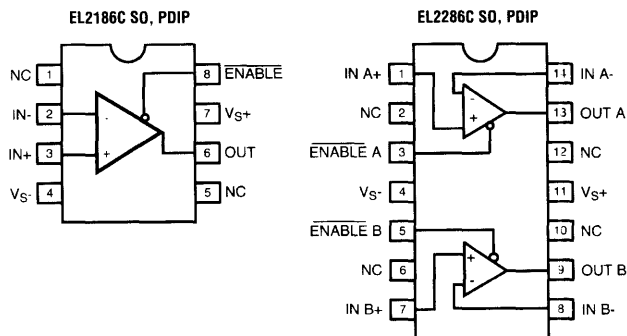

Manufactured under U.S. Patent No. 5,418,495

EL2186C, EL2286C

250MHz/3mA Current Mode Feedback Amp w/Disable

EL2186C, EL2286C

Amplifiers

Absolute Maximum Ratings (T_A = 25 °C)

Voltage between V _{S+} and V _{S-}	+12.6V	Temperature Range	-40°C to +85°C
Common-Mode Input Voltage	V _{S-} to V _{S+}	Operating Junction Temperature	
Differential Input Voltage	±6V	Plastic Packages	150°C
Current into +IN or -IN	±7.5mA	Output Current (EL2186C)	±120mA
Internal Power Dissipation	See Curves	Output Current (EL2286C)	±60mA
Operating Ambient		Storage Temperature Range	-65°C to +150°C

Important Note:

All parameters having Min/Max specifications are guaranteed. Typ values are for information purposes only. Unless otherwise noted, all tests are at the specified temperature and are pulsed tests, therefore: T_J = T_C = T_A

DC Electrical Characteristics

V_S = ±5V, R_L = 150Ω, ENABLE = 0V, T_A = 25°C unless otherwise specified

Parameter	Description	Conditions	Min	Typ	Max	Units
V _{OS}	Input Offset Voltage			2.5	15	mV
TCV _{OS}	Average Input Offset Voltage Drift	Measured from T _{MIN} to T _{MAX}		5		μV/°C
dV _{OS}	V _{OS} Matching	EL2286C only		0.5		mV
+I _{IN}	+ Input Current			1.5	15	μA
d+I _{IN}	+ I _{IN} Matching	EL2286C only		20		nA
-I _{IN}	- Input Current			16	40	μA
d-I _{IN}	-I _{IN} Matching	EL2286C only		2		μA
CMRR	Common Mode Rejection Ratio	V _{CM} = ±3.5V	45	50		dB
-ICMR	- Input Current Common Mode Rejection	V _{CM} = ±3.5V		5	30	μA/V
PSRR	Power Supply Rejection Ratio	V _S is moved from ±4V to ±6V	60	70		dB
-IPSR	- Input Current Power Supply Rejection	V _S is moved from ±4V to ±6V		1	15	μA/V
R _{OL}	Transimpedance	V _{OUT} = ±2.5V	120	300		kΩ
+R _{IN}	+ Input Resistance	V _{CM} = ±3.5V	0.5	2		MΩ
+C _{IN}	+ Input Capacitance			1.2		pF
CMIR	Common Mode Input Range		±3.5	±4.0		V
V _O	Output Voltage Swing	V _S = ±5	±3.5	±4.0		V
		V _S = +5 Single-Supply, High		4.0		V
		V _S = +5 Single-Supply, Low		0.3		V
I _O	Output Current	EL2186C only	80	100		mA
		EL2286C only, per Amplifier	50	55		mA
I _{OUT,OFF}	Output Current Disable	V _{OUT} ±2V, A _V = +1 @ 25°C			10	μA
I _S	Supply Current	ENABLE = 2.0V, per Amplifier		3	6	mA
I _{S(DIS)}	Supply Current (Disabled)	ENABLE = 4.5V		0	50	μA
C _{OUT(DIS)}	Output Capacitance (Disabled)	ENABLE = 4.5V		4.4		pF
R _{EN}	Enable Pin Input Resistance	Measured at ENABLE = 2.0V, 4.5V	45	85		kΩ
I _{IH}	Logic "1" Input Current	Measured at ENABLE, ENABLE = 4.5V		-0.04		μA
I _{IL}	Logic "0" Input Current	Measured at ENABLE, ENABLE = 0V		-53		μA
V _{DIS}	Minimum Voltage at ENABLE to Disable		4.5			V
V _{EN}	Maximum Voltage at ENABLE to Enable				2.0	V

EL2186C, EL2286C**250MHz/3mA Current Mode Feedback Amp w/Disable****AC Electrical Characteristics** $V_S = \pm 5V$, $R_F = R_G = 750\Omega$, $R_L = 150\Omega$, $\text{ENABLE} = 0V$, $T_A = 25^\circ C$ unless otherwise specified

Parameter	Description	Conditions	Min	Typ	Max	Units
-3dB BW	-3dB Bandwidth	$A_V = +1$		250		MHz
-3dB BW	-3dB Bandwidth	$A_V = +2$		180		MHz
0.1dB BW	0.1dB Bandwidth	$A_V = +2$		50		MHz
SR	Slew Rate	$V_{OUT} = \pm 2.5V$, $A_V = +2$	600	1200		V/ μs
t_r , t_f	Rise and Fall Time	$V_{OUT} = \pm 500mV$		1.5		ns
t_{pd}	Propagation Delay	$V_{OUT} = \pm 500mV$		1.5		ns
OS	Overshoot	$V_{OUT} = \pm 500mV$		3.0		%
t_s	0.1% Settling	$V_{OUT} = \pm 2.5V$, $A_V = -1$		15		ns
dG	Differential Gain	$A_V = +2$, $R_L = 150\Omega$ ^[1]		0.05		%
dP	Differential Phase	$A_V = +2$, $R_L = 150\Omega$ ^[1]		0.05		
dG	Differential Gain	$A_V = +1$, $R_L = 500\Omega$ ^[1]		0.01		%
dP	Differential Phase	$A_V = +1$, $R_L = 500\Omega$ ^[1]		0.01		°
t_{ON}	Turn-On Time	$A_V = +2$, $V_{IN} = +1V$, $R_L = 150\Omega$ ^[2]		40	100	ns
t_{OFF}	Turn-Off Time	$A_V = +2$, $V_{IN} = +1V$, $R_L = 150\Omega$ ^[2]		1500	2000	ns
CS	Channel Separation	EL2286C only, $f = 5MHz$		85		dB

- DC offset from 0V to 0.714V. AC amplitude 286mV_{p-p}, $f = 3.58MHz$.
- Measured from the application of the logic signal until the output voltage is at the 50% point between initial and final values.

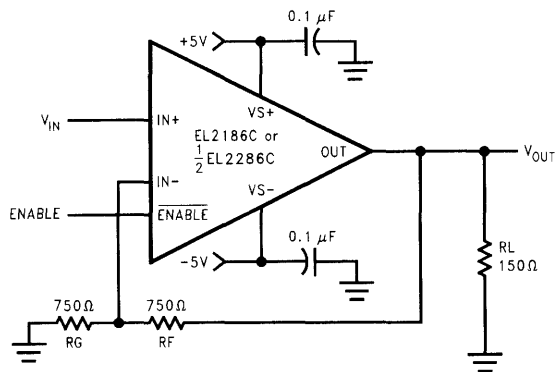
Test Circuit (per Amplifier)

EL2186C, EL2286C

250MHz/3mA Current Mode Feedback Amp w/Disable

EL2186C, EL2286C

Amplifiers

Simplified Schematic (per Amplifier)

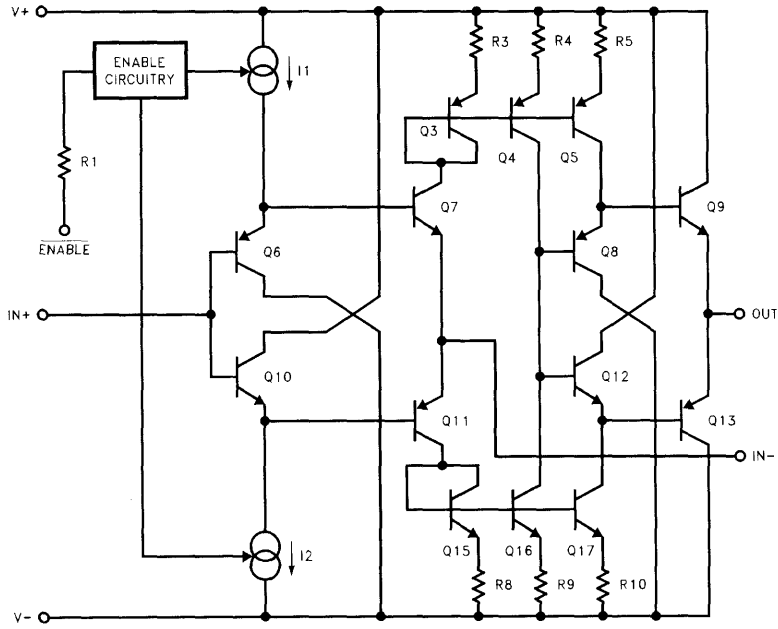

EL2186C, EL2286C

250MHz/3mA Current Mode Feedback Amp w/Disable

Typical Performance Curves

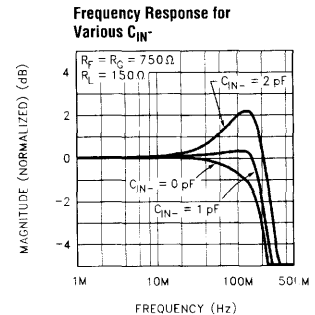
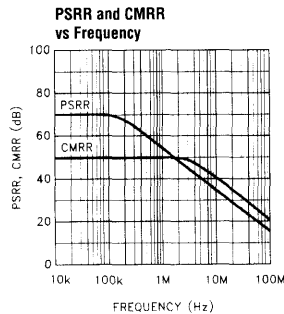
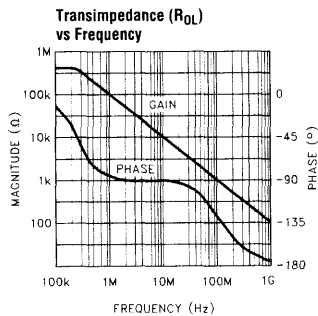
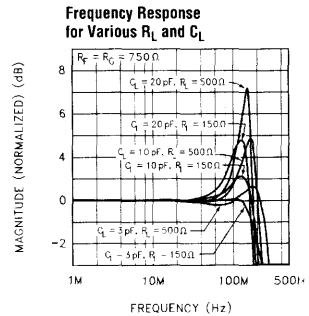
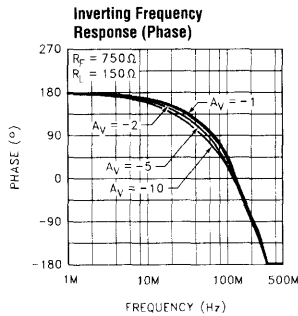
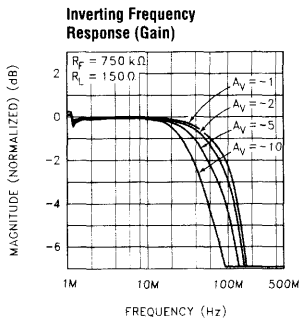
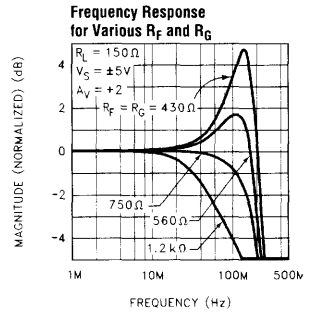
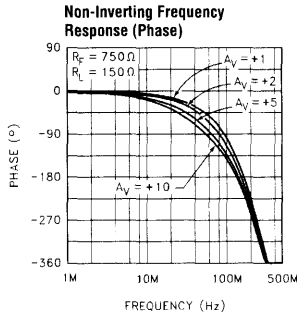
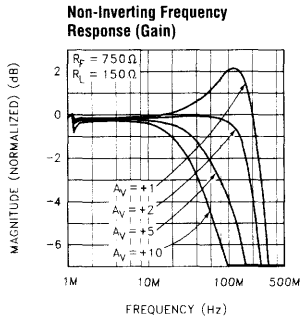

EL2186C, EL2286C

250MHz/3mA Current Mode Feedback Amp w/Disable

EL2186C, EL2286C

Amplifiers

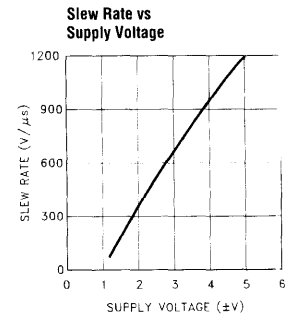
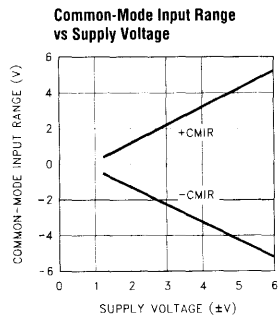
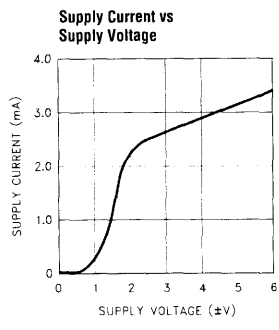
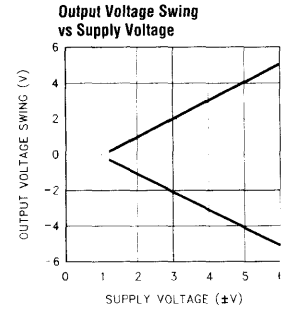
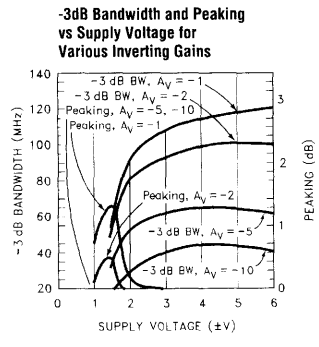
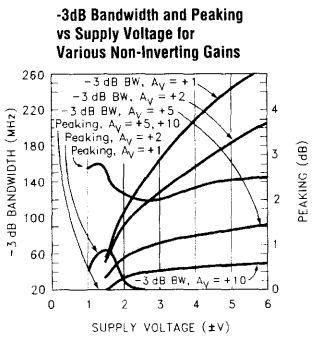
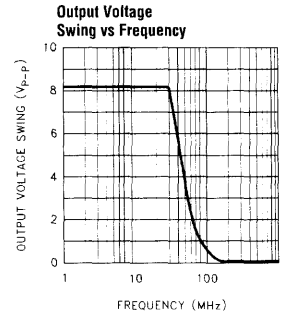
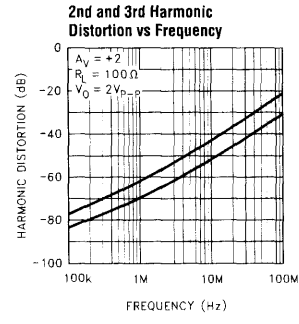
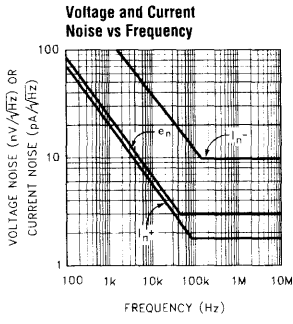

EL2186C, EL2286C

250MHz/3mA Current Mode Feedback Amp w/Disable

Input Bias Current vs Die Temperature

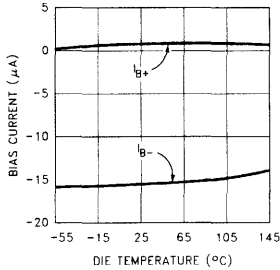

Short-Circuit Current vs Die Temperature

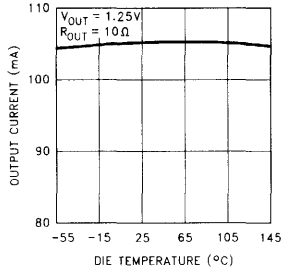

Transimpedance (R_{OL}) vs Die Temperature

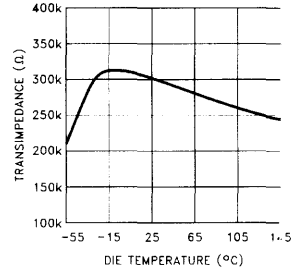

-3dB Bandwidth and Peaking vs Die Temperature for Various Non-Inverting Gains

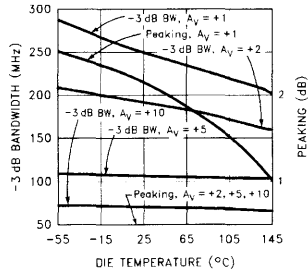

-3dB Bandwidth vs Die Temperature for Various Inverting Gains

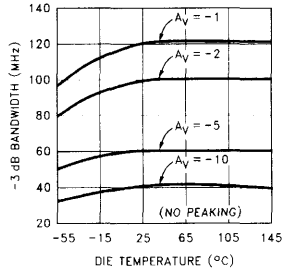

Input Offset Voltage vs Die Temperature

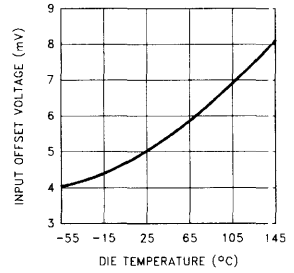

Supply Current vs Die Temperature

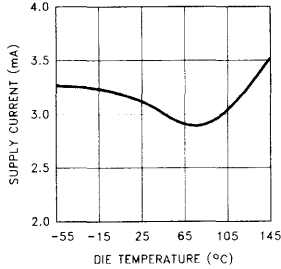

Input Voltage Range vs Die Temperature

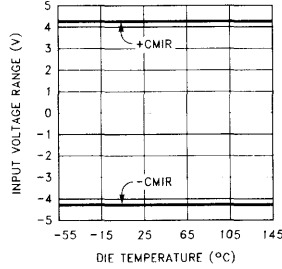

Slew Rate vs Die Temperature

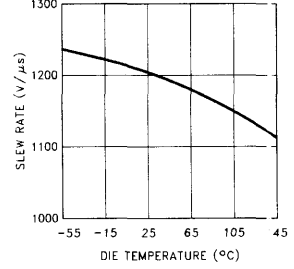

EL2186C, EL2286C

250MHz/3mA Current Mode Feedback Amp w/Disable

EL2186C, EL2286C

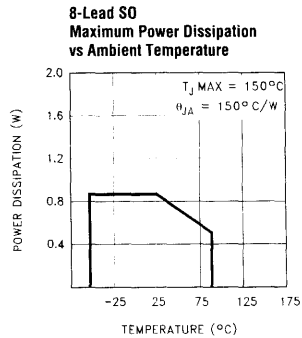
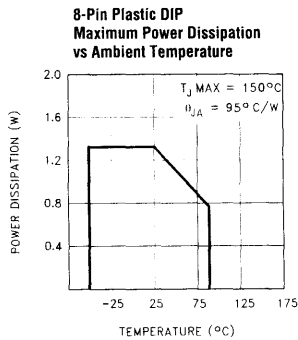
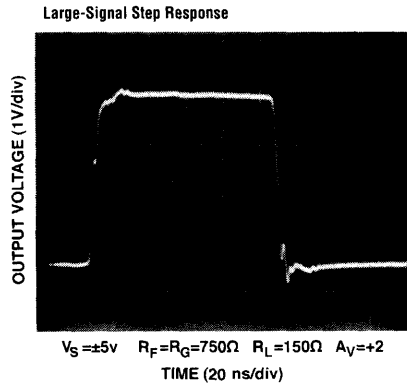
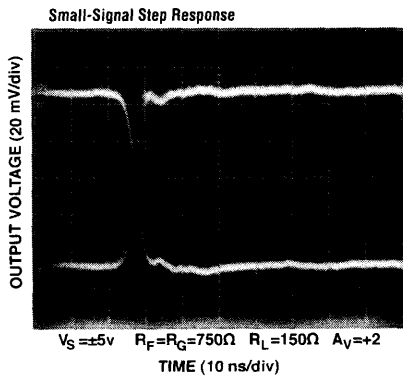
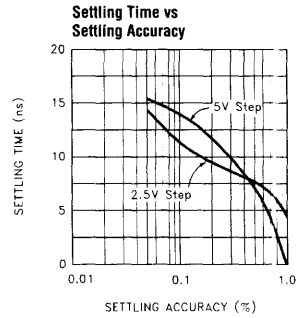
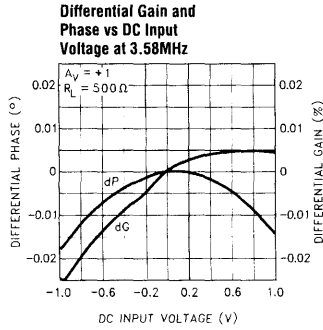
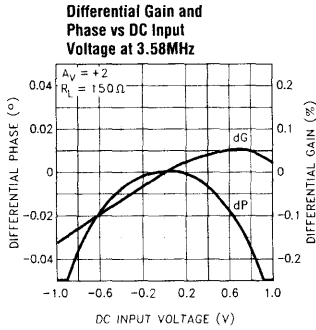

Amplifiers

EL2186C, EL2286C

250MHz/3mA Current Mode Feedback Amp w/Disable

14-Pin Plastic DIP
Maximum Power Dissipation
vs Ambient Temperature

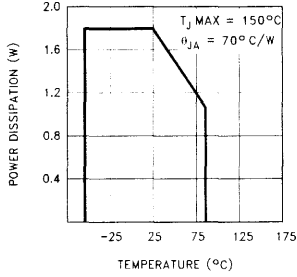

14-Lead SO
Maximum Power Dissipation
vs Ambient Temperature

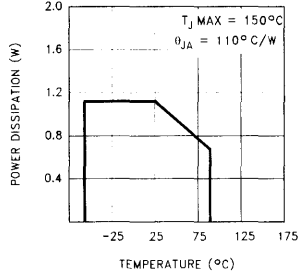

Channel Separation vs Frequency (EL2286)

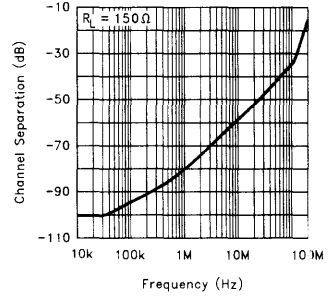

EL2186C, EL2286C

250MHz/3mA Current Mode Feedback Amp w/Disable

Applications Information

Product Description

The EL2186C/EL2286C are current-feedback operational amplifiers that offer a wide -3dB bandwidth of 250MHz, a low supply current of 3mA per amplifier and the ability to disable to 0mA. Both products also feature high output current drive. The EL2186C can output 100mA, while the EL2286C can output 55mA per amplifier. The EL2186C/EL2286C work with supply voltages ranging from a single 3V to $\pm 6V$, and they are also capable of swinging to within 1V of either supply on the input and the output. Because of their current-feedback topology, the EL2186C/EL2286C do not have the normal gain-bandwidth product associated with voltage-feedback operational amplifiers. This allows their -3dB bandwidth to remain relatively constant as closed-loop gain is increased. This combination of high bandwidth and low power, together with aggressive pricing make the EL2186C/EL2286C the ideal choice for many low-power/high-bandwidth applications such as portable computing, HDSL, and video processing.

For Single, Dual and Quad applications without disable, consider the EL2180C (8-Pin Single), EL2280C (8-Pin Dual) and EL2480C (14-Pin Quad). If lower power is required, refer to the EL2170C/EL2176C family which provides Singles, Duals, and Quads with 70MHz of bandwidth while consuming 1mA of supply current per amplifier.

Power Supply Bypassing and Printed Circuit Board Layout

As with any high-frequency device, good printed circuit board layout is necessary for optimum performance. Ground plane construction is highly recommended. Lead lengths should be as short as possible. The power supply pins must be well bypassed to reduce the risk of oscillation. The combination of a 4.7 μF tantalum capacitor in parallel with a 0.1 μF capacitor has been shown to work well when placed at each supply pin.

For good AC performance, parasitic capacitance should be kept to a minimum especially at the inverting input (see the Capacitance at the Inverting Input section). Ground plane construction should be used, but it should be removed from the area near the inverting input to

minimize any stray capacitance at that node. Carbon or Metal-Film resistors are acceptable with the Metal-Film resistors giving slightly less peaking and bandwidth because of their additional series inductance. Use of sockets, particularly for the SO package should be avoided if possible. Sockets add parasitic inductance and capacitance which will result in some additional peaking and overshoot.

Disable/Power-Down

The EL2186C/EL2286C amplifiers can be disabled, placing their output in a high-impedance state. When disabled, each amplifier's supply current is reduced to 0mA. Each EL2186C/EL2286C amplifier is disabled when its $\overline{\text{ENABLE}}$ pin is floating or pulled up to within 0.5V of the positive supply. Similarly, each amplifier is enabled by pulling its $\overline{\text{ENABLE}}$ pin at least 3V below the positive supply. For $\pm 5V$ supplies, this means that an EL2186C/EL2286C amplifier will be enabled when $\overline{\text{ENABLE}}$ is at 2V or less, and disabled when $\overline{\text{ENABLE}}$ is above 4.5V. Although the logic levels are not standard TTL, this choice of logic voltages allows the EL2186C/EL2286C to be enabled by tying $\overline{\text{ENABLE}}$ to ground, even in +3V single-supply applications. The $\overline{\text{ENABLE}}$ pin can be driven from CMOS outputs or open-collector TTL.

When enabled, supply current does vary somewhat with the voltage applied at $\overline{\text{ENABLE}}$. For example, with the supply voltages of the EL2186C at $\pm 5V$, if $\overline{\text{ENABLE}}$ is tied to -5V (rather than ground) the supply current will increase about 15% to 3.45mA.

Capacitance at the Inverting Input

Any manufacturer's high-speed voltage- or current-feedback amplifier can be affected by stray capacitance at the inverting input. For inverting gains this parasitic capacitance has little effect because the inverting input is a virtual ground, but for non-inverting gains this capacitance (in conjunction with the feedback and gain resistors) creates a pole in the feedback path of the amplifier. This pole, if low enough in frequency, has the same destabilizing effect as a zero in the forward open-loop response. The use of large value feedback and gain

EL2186C, EL2286C

250MHz/3mA Current Mode Feedback Amp w/Disable

resistors further exacerbates the problem by further lowering the pole frequency.

The EL2186C/EL2286C have been specially designed to reduce power dissipation in the feedback network by using large 750Ω feedback and gain resistors. With the high bandwidths of these amplifiers, these large resistor values would normally cause stability problems when combined with parasitic capacitance, but by internally canceling the effects of a nominal amount of parasitic capacitance, the EL2186C/EL2286C remain very stable. For less experienced users, this feature makes the EL2186C/EL2286C much more forgiving, and therefore easier to use than other products not incorporating this proprietary circuitry.

The experienced user with a large amount of PC board layout experience may find in rare cases that the EL2186C/EL2286C have less bandwidth than expected. In this case, the inverting input may have less parasitic capacitance than expected

by the internal compensation circuitry of the EL2186C/EL2286C. The reduction of feedback resistor values (or the addition of a very small amount of external capacitance at the inverting input, e.g. 0.5pF) will increase bandwidth as desired. Please see the curves for Frequency Response for Various R_F and R_G , and Frequency Response for Various C_{IN} .

Feedback Resistor Values

The EL2186C/EL2286C have been designed and specified at gains of +1 and +2 with $R_F = 750\Omega$. This value of feedback resistor gives 250MHz of -3dB bandwidth at $A_V = +1$ with about 2.5dB of peaking, and 180MHz of -3dB bandwidth at $A_V = +2$ with about 0.1dB of peaking. Since the EL2186C/EL2286C are current-feedback amplifiers, it is also possible to change the value of R_F to get more bandwidth. As seen in the curve of Frequency Response For Various R_F and R_G , bandwidth and peaking can be easily modified by varying the value of the feedback resistor.

Because the EL2186C/EL2286C are current-feedback amplifiers, their gain-bandwidth product is not a constant for different closed-loop gains. This feature actually allows the EL2186C/EL2286C to maintain about the same -3dB bandwidth, regardless of closed-

loop gain. However, as closed-loop gain is increased, bandwidth decreases slightly while stability increases.

Since the loop stability is improving with higher closed-loop gains, it becomes possible to reduce the value of R_F below the specified 750Ω and still retain stability, resulting in only a slight loss of bandwidth with increased closed-loop gain.

Supply Voltage Range and Single-Supply Operation

The EL2186C/EL2286C have been designed to operate with supply voltages having a span of greater than 3V, and less than 12V. In practical terms, this means that the EL2186C/EL2286C will operate on dual supplies ranging from $\pm 1.5V$ to $\pm 6V$. With a single-supply, the EL2186C will operate from +3V to +12V.

As supply voltages continue to decrease, it becomes necessary to provide input and output voltage ranges that can get as close as possible to the supply voltages. The EL2186C/EL2286C have an input voltage range that extends to within 1V of either supply. So, for example, on a single +5V supply, the EL2186C/EL2286C have an input range which spans from 1V to 4V. The output range of the EL2186C/EL2286C is also quite large, extending to within 1V of the supply rail. On a $\pm 5V$ supply, the output is therefore capable of swinging from -4V to +4V. Single-supply output range is even larger because of the increased negative swing due to the external pull-down resistor to ground. On a single +5V supply, output voltage range is about 0.3V to 4V.

Video Performance

For good video performance, an amplifier is required to maintain the same output impedance and the same frequency response as DC levels are changed at the output. This is especially difficult when driving a standard video load of 150Ω, because of the change in output current with DC level. Until the EL2186C/EL2286C, good Differential Gain could only be achieved by running high idle currents through the output transistors (to reduce variations in output impedance). These currents were typically comparable to the entire 3mA supply current of each EL2186C/EL2286C amplifier! Special circuitry has been incorporated in the EL2186C/EL2286C to reduce the variation of output impedance with current

EL2186C, EL2286C

250MHz/3mA Current Mode Feedback Amp w/Disable

output. This results in dG and dP specifications of 0.05% and 0.05° while driving 150Ω at a gain of +2.

Video Performance has also been measured with a 500Ω load at a gain of +1. Under these conditions, the EL2186C/EL2286C have dG and dP specifications of 0.01% and 0.01° respectively while driving 500Ω at $A_V = +1$.

Output Drive Capability

In spite of its low 3mA of supply current, the EL2186C is capable of providing a minimum of ±80mA of output current. Similarly, each amplifier of the EL2286C is capable of providing a minimum of ±50mA. These output drive levels are unprecedented in amplifiers running at these supply currents. With a minimum ±80mA of output drive, the EL2186C is capable of driving 50Ω loads to ±4V, making it an excellent choice for driving isolation transformers in telecommunications applications. Similarly, the ±50mA minimum output drive of each EL2286C amplifier allows swings of ±2.5V into 50Ω loads.

Driving Cables and Capacitive Loads

When used as a cable driver, double termination is always recommended for reflection-free performance. For those applications, the back-termination series resistor will decouple the EL2186C/EL2286C from the cable and allow extensive capacitive drive. However, other applications may have high capacitive loads without a back-termination resistor. In these applications, a small series resistor (usually between 5Ω and 50Ω) can be placed in series with the output to eliminate most peaking. The gain resistor (R_G) can then be chosen to make up for any gain loss which may be created by this additional resistor at the output. In many cases it is also

possible to simply increase the value of the feedback resistor (R_F) to reduce the peaking.

Current Limiting

The EL2186C/EL2286C have no internal current-limiting circuitry. If any output is shorted, it is possible to exceed the Absolute Maximum Ratings for output current or power dissipation, potentially resulting in the destruction of the device.

Power Dissipation

With the high output drive capability of the EL2186C/EL2286C, it is possible to exceed the 150°C Absolute Maximum junction temperature under certain very high load current conditions. Generally speaking, when R_L falls below about 25Ω, it is important to calculate the maximum junction temperature (T_{JMAX}) for the application to determine if power-supply voltages, load conditions, or package type need to be modified for the EL2186C/EL2286C to remain in the safe operating area. These parameters are calculated as follows:

$$T_{JMAX} = T_{MAX} + (\theta_{JA} * n * PD_{MAX})$$

Where:

- T_{MAX} = Maximum Ambient Temperature
- θ_{JA} = Thermal Resistance of the Package
- n = Number of Amplifiers in the Package
- PD_{MAX} = Maximum Power Dissipation of Each Amplifier in the Package.

PD_{MAX} for each amplifier can be calculated as follows:

$$PD_{MAX} = (2 * V_S * I_{SMAX}) + (V_S - V_{OUTMAX}) * (V_{OUTMAX} / R_L)$$

Where:

- V_S = Supply Voltage
- I_{SMAX} = Maximum Supply Current of 1 Amplifier
- V_{OUTMAX} = Max. Output Voltage of the Application
- R_L = Load Resistance

EL2186C, EL2286C

250MHz/3mA Current Mode Feedback Amp w/Disable

Typical Application Circuits

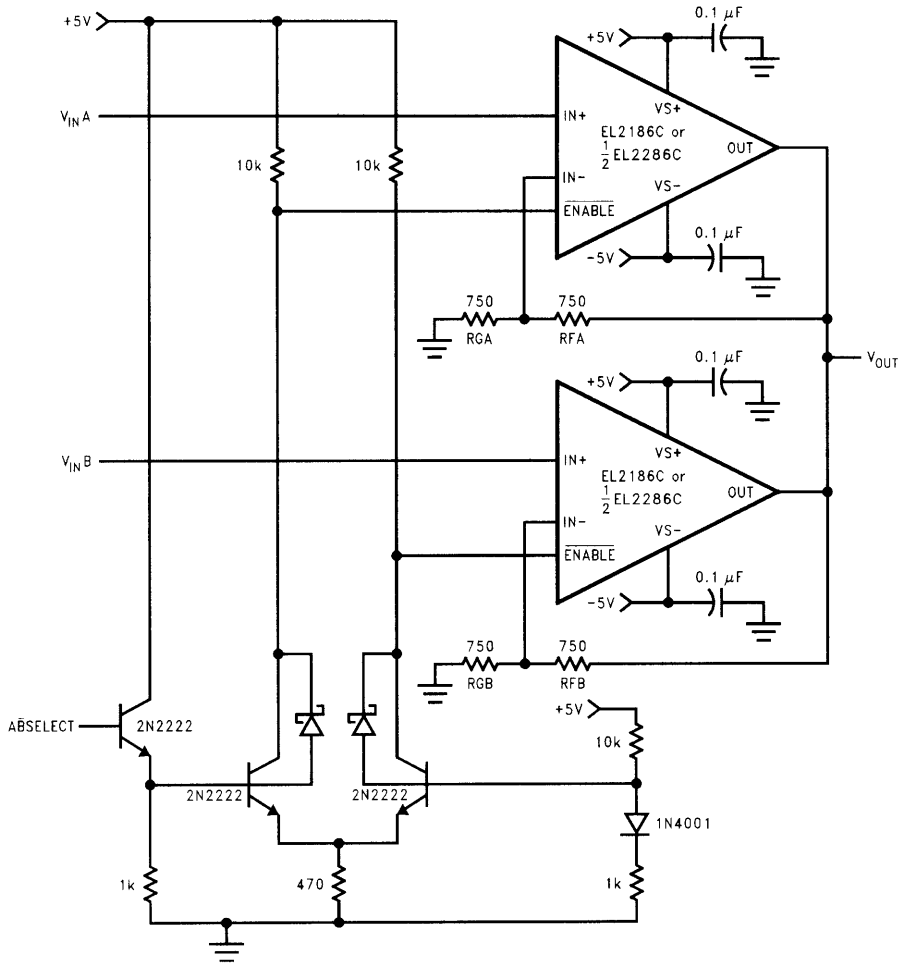

Low Power Multiplexer with Single-Ended TTL Input

EL2186C, EL2286C

250MHz/3mA Current Mode Feedback Amp w/Disable

EL2186C, EL2286C

Amplifiers

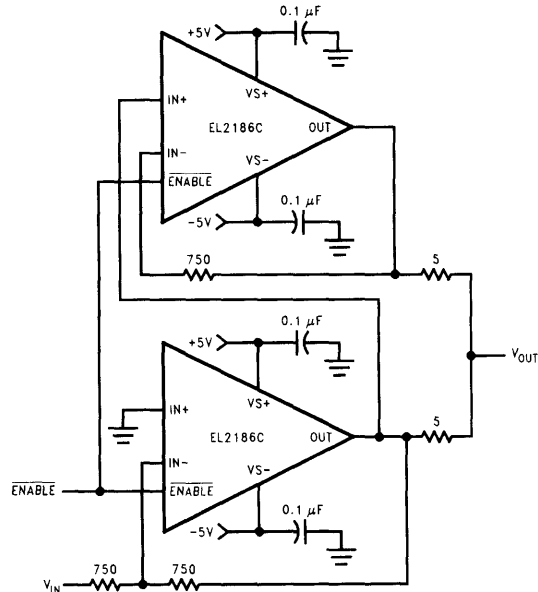

Inverting 200mA Output Current Distribution Amplifier

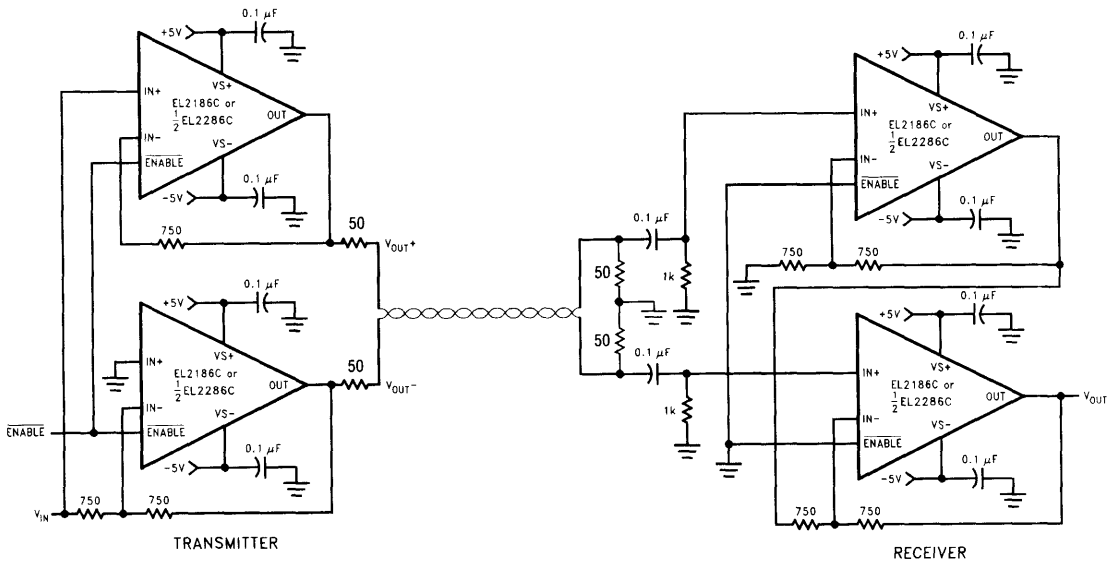

Differential Line-Driver/Receiver

EL2186C, EL2286C

250MHz/3mA Current Mode Feedback Amp w/Disable

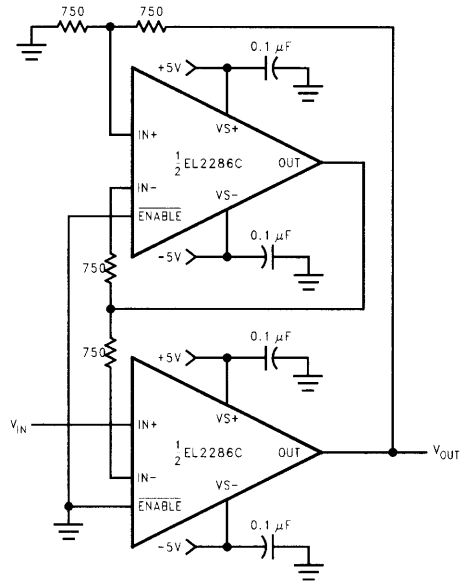

Fast-Settling Precision Amplifier

EL2186C, EL2286C

250MHz/3mA Current Mode Feedback Amp w/Disable

EL2186C, EL2286C

Amplifiers

EL2186C/EL2286C Macromodel

```
* EL2186 Macromodel
* Revision A, March 1995
* AC characteristics used: Rf = Rg = 750 ohms
* Connections:
*
*      +input
*      |
*      | -input
*      |
*      | +Vsupply
*      | |
*      | | -Vsupply
*      | |
*      | | output
*      |
*
.subckt EL2186/el 3 2 7 4 6
*
* Input Stage
*
e1 10 0 3 0 1.0
vis 10 9 0 V
h2 9 12 vxx 1.0
r1 2 11 400
l1 11 12 25 nH
iinp 3 0 1.5 uA
iinm 2 0 3 uA
rl2 3 0 2 Meg
*
* Slew Rate Limiting
*
h1 13 0 vis 600
r2 13 14 1 K
d1 14 0 dclamp
d2 0 14 dclamp
*
* High Frequency Pole
*
e2 30 0 14 0 0.001666666666
l3 30 17 150 nH
c5 17 0 0.8 pF
r5 17 0 165
*
* Transimpedance Stage
*
g1 0 18 17 0 1.0
rol 18 0 450 K
cdp 18 0 0.675 pF
*
* Output Stage
*
q1 4 18 19 qp
q2 7 18 20 qn
q3 7 19 21 qn
q4 4 20 22 qp
r7 21 6 4
r8 22 6 4
ios1 7 19 1 mA
ios2 20 4 1 mA
*
* Supply Current
ips 7 4 0.2 mA
*
* Error Terms
*
ivos 0 23 0.2 mA
vxx 23 0 0V
e4 24 0 3 0 1.0
e5 25 0 7 0 1.0
```

EL2186C, EL2286C**250MHz/3mA Current Mode Feedback Amp w/Disable**

```
e6 26 0 4 0 -1.0
r9 24 23 316
r10 25 23 3.2 K
r11 26 23 3.2 K
*
* Models
*
.model qn npn(is=5e-15 bf=200 tf=0.01nS)
*.model qp pnp(is=5e-15 bf=200 tf=0.01nS)
.model dclamp d(is=1e-30 ibv=0.266
+ bv=0.71v n=4)
.ends
```

EL2186C, EL2286C

250MHz/3mA Current Mode Feedback Amp w/Disable

EL2186C, EL2286C

EL2186C/EL2286C Macromodel

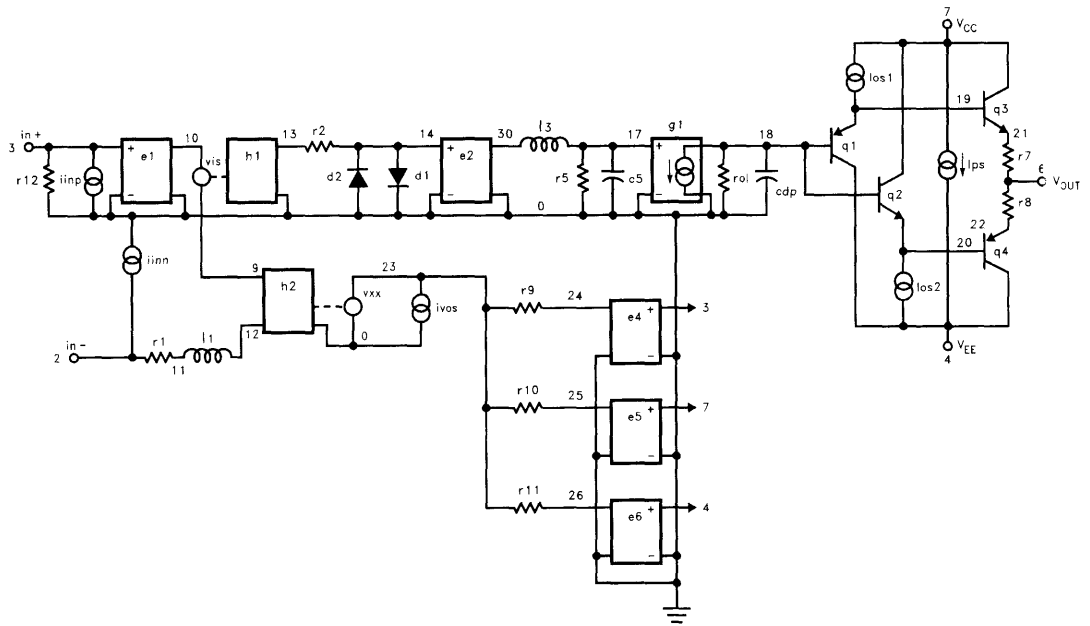

Amplifiers