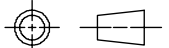

MATERIAL AND FINISHES

SEE SD-73412-050

P/N: 73118-0250: THIS IS P/N: 73412-0502 PLACED IN A SINGLE BAG WITH LABEL

| | | | | | | | | | | | | | | | | |
|--|---|--|------------|-----------------|----|--------------|----|---|---|--|-----------------|---|----------|---|---|---|
| QUALITY SYMBOLS | THIS DRAWING CONTAINS INFORMATION THAT IS PROPRIETARY TO MOLEX ELECTRONIC TECHNOLOGIES, LLC AND SHOULD NOT BE USED WITHOUT WRITTEN PERMISSION | | | | | | | | | | | | | | | |
| ▽ = 0 ▽ = 0 ▽ = 0 ▼ = 0 ▽ = 0 ☒ = 0 ■ = 0 ▽ = 0 | MIGRATED EC NO: 170295 DRWN: LIMEIER CHKD: SSSHAH REV / APPR: AROBERTSON | GENERAL TOLERANCES (UNLESS SPECIFIED) | | DIMENSION UNITS | | SCALE | |  | | | | | | | | |
| | | | | INCH | | NTS | | | | | | | | | | |
| | | | | MM INCH | | DRWN BY | | DATE | | CA MCRF25 TO MCRF25, 50 OHM ON 1.32 GREY CABLE CA-MCRF25/MCRF25 | | | | | | |
| | | 4 PLACES ± | | ± | | AROBERTSON | | 2011/05/04 | | | | | | | | |
| | | 3 PLACES ± | | ± | | CHK'D BY | | DATE | | | | | | | | |
| | | 2 PLACES ± | | ± | | SSS | | 2011/05/04 | | | | | | | | |
| | | 1 PLACES ± | | ± | | APPR BY | | DATE | | | | | | | | |
| | | 0 PLACES ± | | ± | | JWIENER | | 2011/05/05 | | PRODUCT CUSTOMER DRAWING | | | | | | |
| | | ANGULAR TOL ± | | | | DRAWING SIZE | | THIRD ANGLE PROJECTION | | SERIES | MATERIAL NUMBER | | CUSTOMER | | | |
| | | DRAFT WHERE APPLICABLE MUST REMAIN WITHIN DIMENSIONS | | | | C | |  | | 73118 | SEE NOTE | | | | | |
| RELEASE STATUS | P1 | RELEASE DATE | 10.01.2018 | 16:32:05 | 12 | 11 | 10 | 9 | 8 | 7 | 6 | 5 | 4 | 3 | 2 | 1 |

MATERIALS AND FINISHES

MATED HEIGHT: .098 [2.5]

BODY: PHOSPHOR BRONZE
PLATED GOLD

CENTER CONTACT: PHOSPHOR BRONZE
PLATED GOLD

HOUSING: PBT

CABLE: 1.32 CABLE
COLOR: GREY

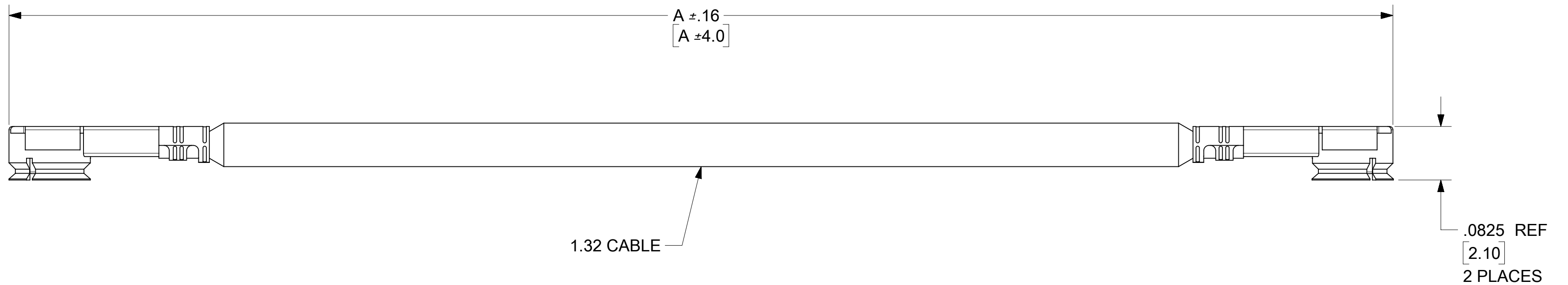
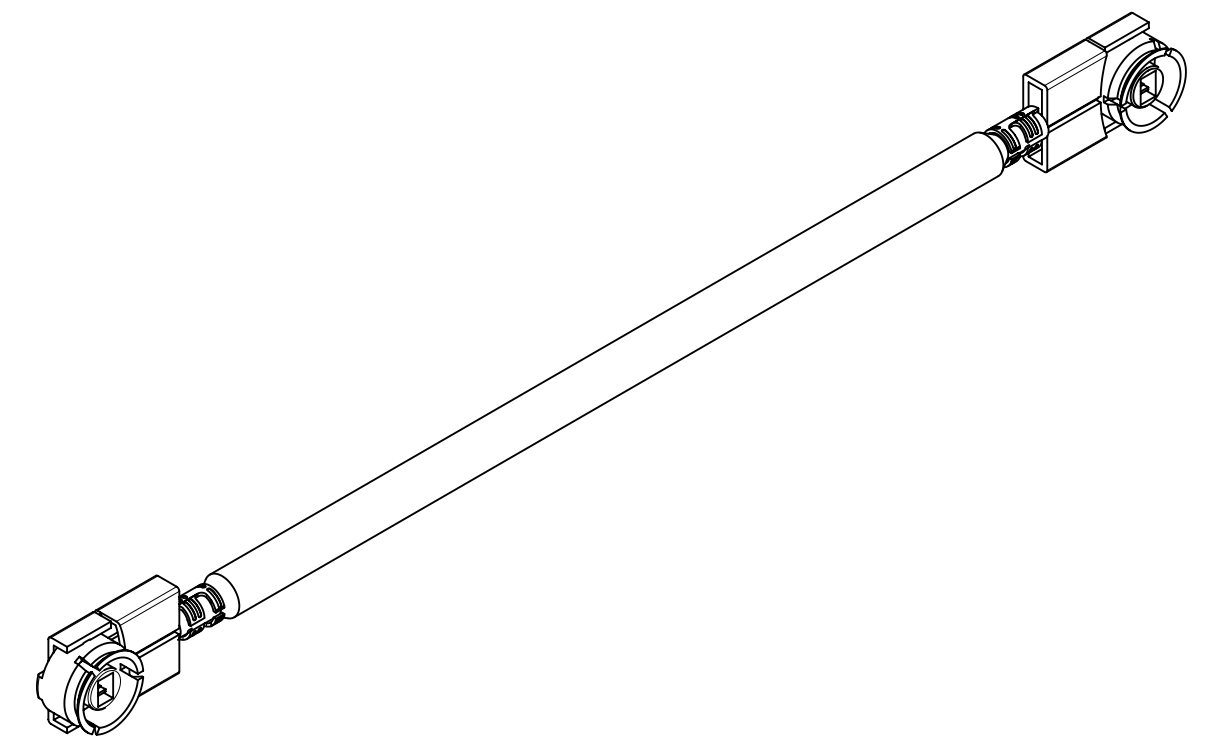

| | | | |
|---|-------------|-------------|-------|
| 5 | 73412-0508 | 1.97 | 50.0 |
| 4 | 73412-0506 | 3.54 | 90.0 |
| 3 | 73412-0504 | 6.38 | 162.0 |
| 2 | 73412-0502 | 4.33 | 110.0 |
| 1 | 73412-0500 | 1.65 | 42.0 |
| | PART NUMBER | INCH | MM |
| | | DIMENSION A | |

PART NUMBER: 73118-0250 IS 73412-0502
PACKAGED ONE PIECE PER BAG

| | | | | | | |
|--|---|---------------------------------------|--------------|------------------------|------------|------------|
| QUALITY SYMBOLS ▽ = 0 ▽ = 0 ▽ = 0 ▽ = 0 ▽ = 0 ▽ = 0 ▽ = 0 ▽ = 0 ▽ = 0 | THIS DRAWING CONTAINS INFORMATION THAT IS PROPRIETARY TO MOLEX ELECTRONIC TECHNOLOGIES, LLC AND SHOULD NOT BE USED WITHOUT WRITTEN PERMISSION | | | | | |
| | MIGRATED EC NO: 176762 DRWN: JSU18 CHKD: YCHENG REV / APPR: YCHENG | GENERAL TOLERANCES (UNLESS SPECIFIED) | | DIMENSION UNITS | SCALE | |
| | | | MM | INCH | INCH | NTS |
| | | 4 PLACES | ± | ± | DRWN BY | DATE |
| | | 3 PLACES | ± | ± | YCHENG | 2010/04/30 |
| | 2 PLACES | ± | ± | CHK'D BY | DATE | |
| | 1 PLACES | ± | ± | KERRIE | 2010/04/30 | |
| | 0 PLACES | ± | ± | APPR BY | DATE | |
| | | | | MHUANG | 2010/05/10 | |
| | ANGULAR TOL = 2.0 | | DRAWING SIZE | THIRD ANGLE PROJECTION | | |
| | DRAFT WHERE APPLICABLE MUST REMAIN WITHIN DIMENSIONS | | C | | | |
| | C6 | | | | | |



CA MCRF25 TO MCRF25 WITH
1.32 GREY CABLE CA-MCRF25/MCRF25

PRODUCT CUSTOMER DRAWING

| | | |
|--------|-----------------|----------|
| SERIES | MATERIAL NUMBER | CUSTOMER |
| 73412 | SEE TABLE | |

| | | | |
|-----------------|----------|----------|--------------|
| DOCUMENT NUMBER | DOC TYPE | DOC PART | SHEET NUMBER |
| SD-73412-050 | PSD | 001 | 1 OF 2 |

| | | |
|-----|------------|-----------------------------------|
| C6 | 2018/05/15 | JUSTIFY PACKAGE SPEC AND QUANTITY |
| REV | DATE | DESCRIPTION |

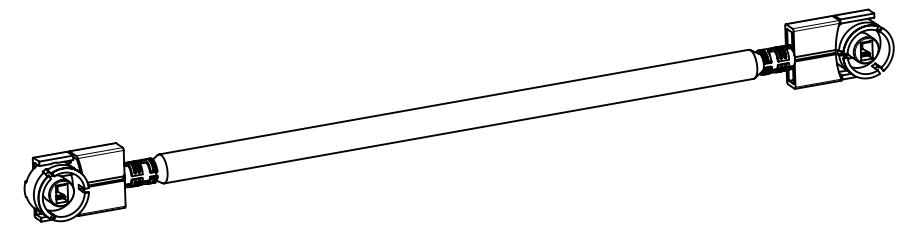

PART NUMBER: 73412-050x

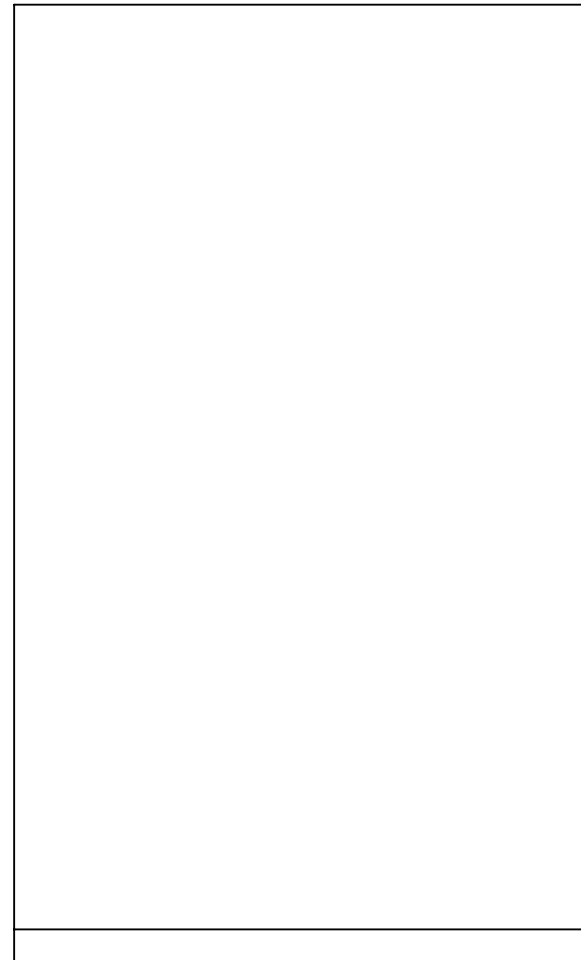
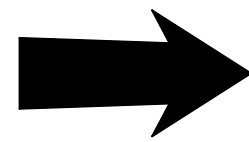

1000 PIECES PER BAG
BAG P/N: 89707-0174

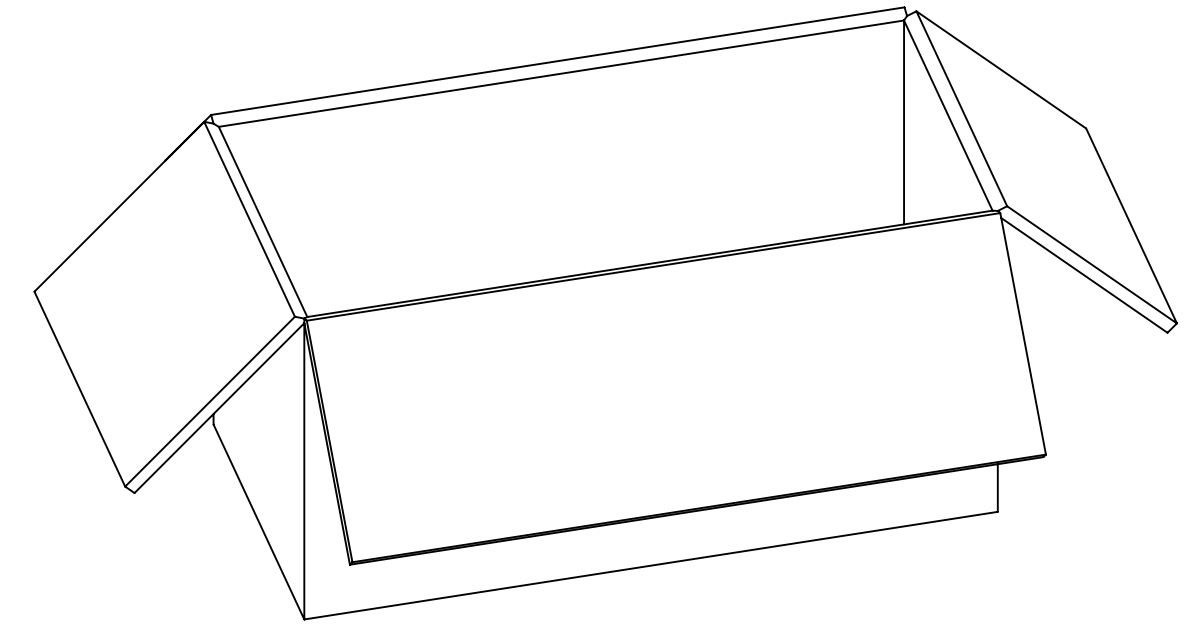
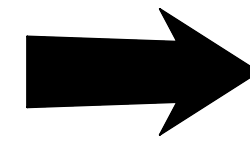

1000 PIECES MAX PER CARTON BOX
CARTON BOX P/N: 96707-0003

| | | | | | | | | | | | | |
|----------------------------|---|--|--|---------|-----------------|--------------------------|-----------------|----------|--|--|--|--|
| QUALITY SYMBOLS | THIS DRAWING CONTAINS INFORMATION THAT IS PROPRIETARY TO MOLEX ELECTRONIC TECHNOLOGIES, LLC AND SHOULD NOT BE USED WITHOUT WRITTEN PERMISSION | | | | | | | | | | | |
| | EC NO: 176762 DRWN: JSU18 CHKD: YCHENG REV / APPR: YCHENG | 2018/05/15 2018/05/17 2018/05/17 | GENERAL TOLERANCES (UNLESS SPECIFIED) | | DIMENSION UNITS | SCALE | | | | | | |
| | | | | | INCH | 1:4 | | | | | | |
| | | | | | MM | INCH | DRWN BY | DATE | CA MCRF25 TO MCRF25 WITH 1.32 GREY CABLE CA-MCRF25/MCRF25 | | | |
| | | | 4 PLACES | ± | ± | JTSAO | 2004/11/11 | | | | | |
| | | | 3 PLACES | ± | ± | CHK'D BY | DATE | | | | | |
| | 2 PLACES | ± | ± | KERRIE | 2004/11/15 | PRODUCT CUSTOMER DRAWING | | | | | | |
| | 1 PLACES | ± | ± | APPR BY | DATE | | | | | | | |
| | 0 PLACES | ± | ± | MHUANG | 2004/11/16 | SERIES | MATERIAL NUMBER | CUSTOMER | | | | |
| | ANGULAR TOL = 2.0 | | DRAFT WHERE APPLICABLE MUST REMAIN WITHIN DIMENSIONS | | DRAWING SIZE | THIRD ANGLE PROJECTION | 73412 | | | | | |
| C6 | | | | C | | DOCUMENT NUMBER | DOC TYPE | DOC PART | SHEET NUMBER | | | |
| | | | | | | SD-73412-050 | PSD | 001 | 2 OF 2 | | | |