

Xinger® III

Doherty Combiner



Description

The X3DC35P1S is a low profile, high performance Doherty Combiner in a new easy to use, manufacturing friendly surface mount package. The X3DC35P1S is designed particularly for Doherty Amplifier applications, where tightly controlled phase and amplitude imbalance as well as low insertion loss are required for maximum and low power condition. It can be used in high power applications up to 40 watts.

Parts have been subjected to rigorous qualification testing and they are manufactured using materials with coefficients of thermal expansion (CTE) compatible with common substrates such as FR4, G-10, RF-35, RO4350 and polyimide. Produced with 6 of 6 RoHS compliant tin immersion finish

Features:

- 3500-3600 MHz
- Low Amp Imbalance
- Low Loss
- Production Friendly
- Tape and Reel
- Lead Free

Electrical Specifications **

Frequency	Return Loss [1]	Insertion Loss [1]	Amplitude Imbalance [1]	Phase Imbalance [1]	Operating Temp.
MHz	dB Min	dB Max	dB Max	Degrees	°C
3500-3600	22	0.20	±0.20	90 ± 3.0	-55 to +95
	Return Loss [2]	Insertion Loss [2]	Port Extension [3]	Power	ΘJC
	dB Min	dB Max	Degrees	Avg. CW Watts	°C/Watt
	20	0.30	7	2 x 40	42.5

**Specification based on performance of unit properly installed on Anaren Test Board

[1] At maximum power condition, Doherty combiner functions as an equal-split power combiner.

[2] At low power condition, Doherty combiner functions as a 100Ω to 50Ω impedance transformer.

[3] There are short 50 ohm lines associated with input ports of 7° at 3550MHz. Details in page 2.

[4] 40W output from each PA for short duration @ max power condition. Details in page 5.

Mechanical Outline

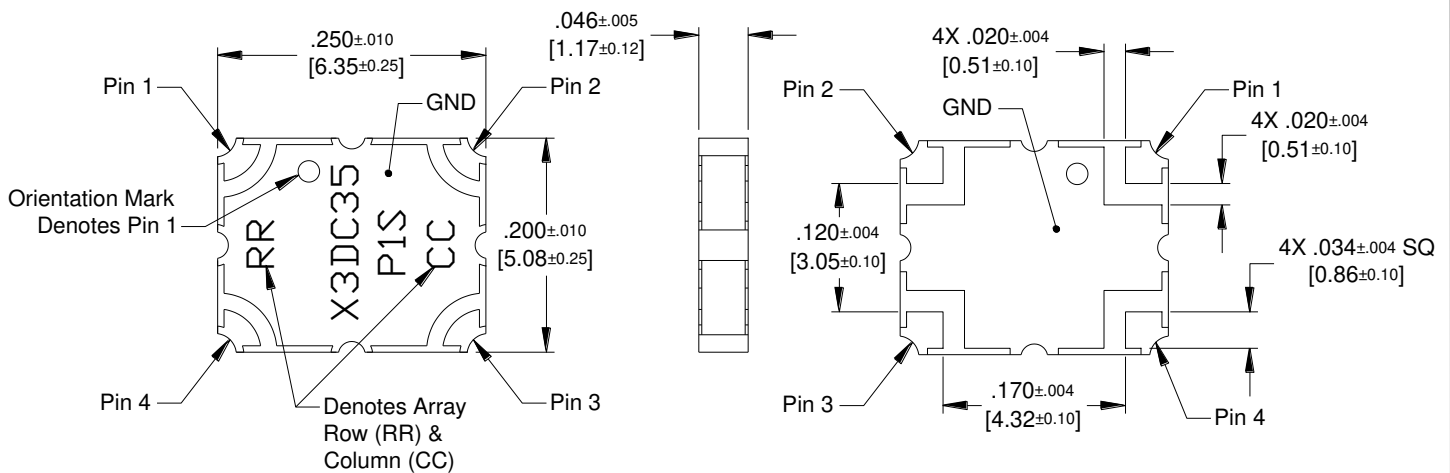

Dimensions are in Inches [Millimeters]
X3DC35P1S Mechanical Outline

Tolerance are Non-cumulative



Doherty Amplifier Configuration

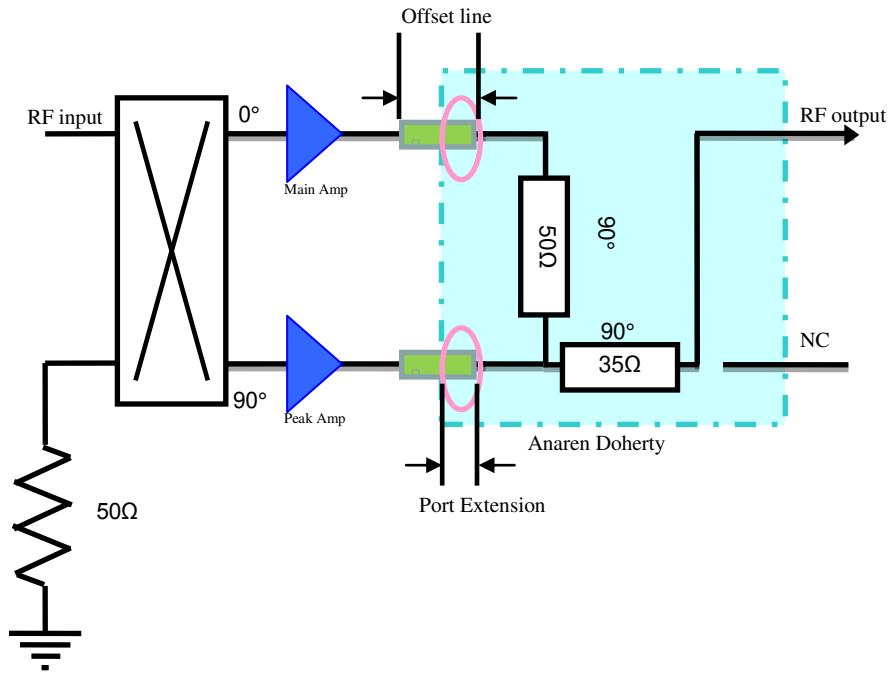

Doherty Combiner Pin Configuration

The X3DC35P1S has an orientation marker to denote Pin 1. Once port one has been identified the other ports are known automatically. Please see the chart below for clarification:

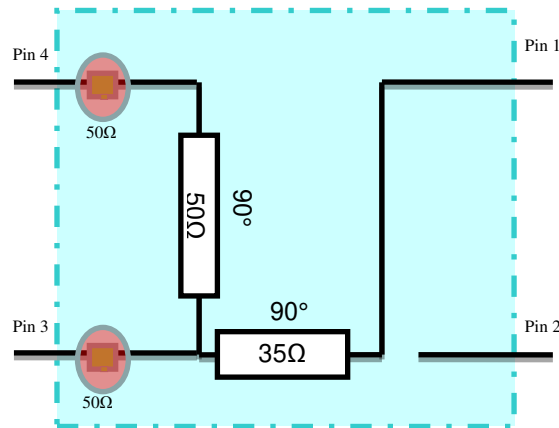

Pin 1	Pin 2	Pin 3	Pin 4
Combing Port	Not Used	Peak Amp Port	Main Amp Port

There are inevitably short lines associating with input ports in some high frequency band parts. The length of the short line is specified as electrical length at center frequency and noted as port extension in this datasheet. The designer should take this length into the consideration to optimize the offset line length.



Typical Performance (25°C): 3500-3600 MHz

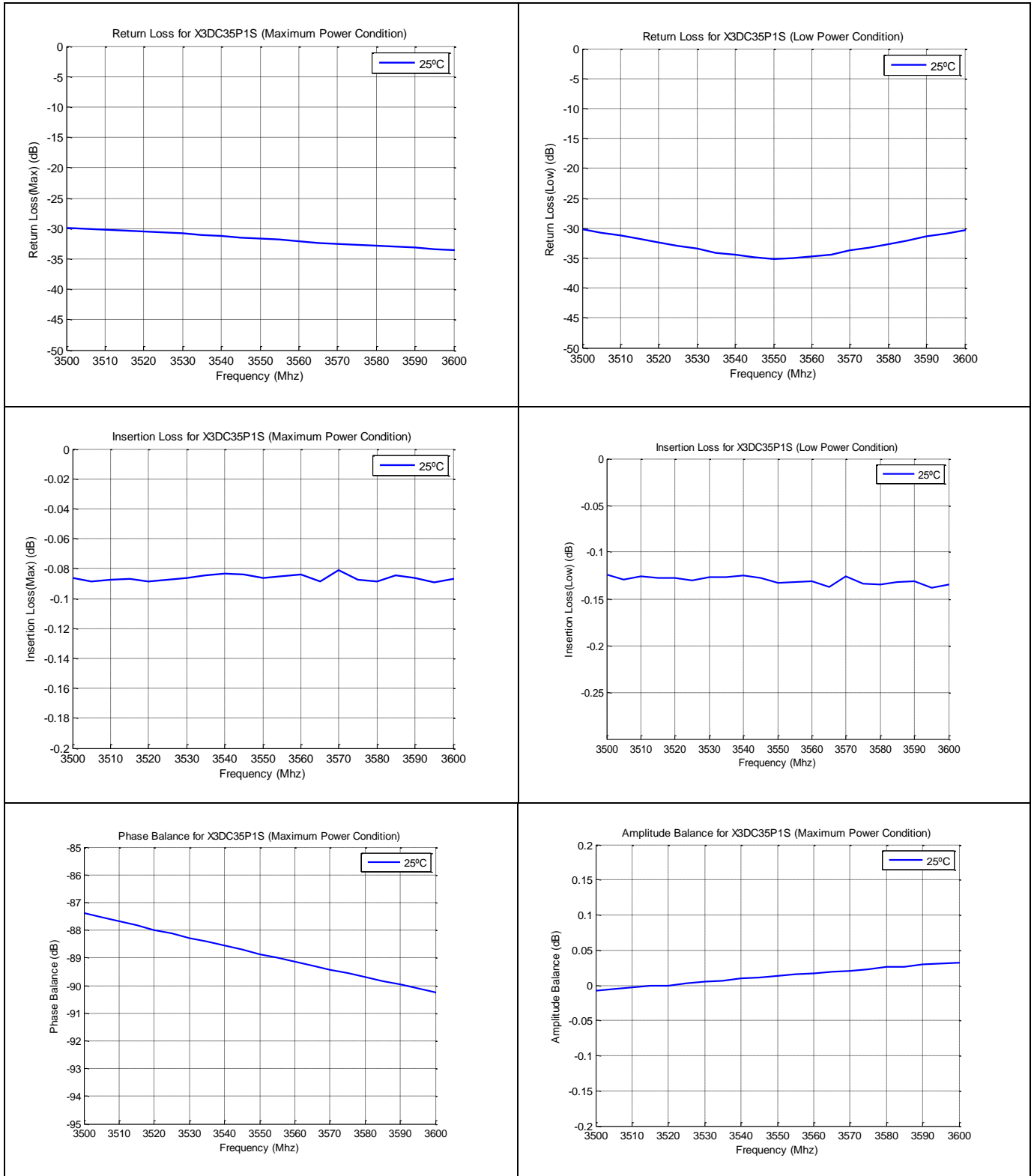

Definition of the Specifications

To guarantee the part performance in Doherty architecture, the part is specified in Doherty operation for maximum power condition and low power condition. The following specification definition assumes the extra port extension is already applied to the raw S parameter and the parts is measured with Pin n connected to Port n (where n=1, 2, 3, 4).

- Maximum power condition**

Under the maximum power condition, the symmetrical Doherty architecture requires main amplifier and peak amplifier to work at full capacity with the optimum termination (50 Ω). The two amplifiers should deliver RF power of equal magnitude and 90 degree phase difference. Doherty combiner functions as a coherent power combiner and supplies the 90 degree phase compensation. The following specification is defined with 50 Ω port impedance at three ports for this condition. The return loss and the insertion loss in max power mode are not affected by the 50 ohm lossless port rotation mentioned in electrical spec table in page 1. The phase imbalance and the amplitude imbalance are not affected either since port rotation are taken off equally from the main and the peak amp port.

Parameter	Definition	Mathematical Representation
Return Loss	The impedance match at the combining port to a 50Ω system.	$20\log S_{11} $
Insertion Loss	The combined power divided by the sum of input power under the perfect combining condition.	$10\log (S_{13} ^2 + S_{14} ^2)$
Phase Imbalance	The phase difference between Peak-Combined path and Main-Combined path at $\omega_c = 3550\text{MHz}$.	Phase ($S_{14}(\omega_c)$) – Phase ($S_{13}(\omega_c)$)
Amplitude Imbalance	The magnitude difference between Peak-Combined path and Main-Combined path.	$\frac{(20\log S_{14} - 20\log S_{13})}{2}$

- Low power condition**

Under low power condition, the Doherty operation turns off peak amplifier and requires main amplifier to be terminated with double of the optimum impedance (100 Ω). In this configuration, Doherty combiner servers as an impedance transformer transforming 50 Ω at combining port to 100 Ω at main amplifier port. The following specification is defined under the port impedance condition of Port 1 (Combining Port) 50 Ω, Port 4 (Main Amp Port) 100 Ω and Port 3 (Peak Amp Port) open. With the peak amp left off, the extra line length in that port (see figure in page 2) acts as an open stub which shifts the low power mode return loss null and insertion loss. The offset line length needs to be adjusted taking the port rotation number into consideration so that the junction of 50 Ω and 35 Ω transmission line sees high impedance instead of the part edge. The return loss and the insertion loss defined below are after the offset line adjustments specified in the spec table.

Parameter	Definition	Mathematical Representation
Return Loss	The impedance match of the 50 to 100 Ω transformer.	$20\log S_{11} $
Insertion Loss	The output power divided by input power.	$20\log S_{41} $



Mounting Footprint

To ensure proper electrical and thermal performance there must be a ground plane with 100% solder connection underneath the part orientated as shown with text facing up.

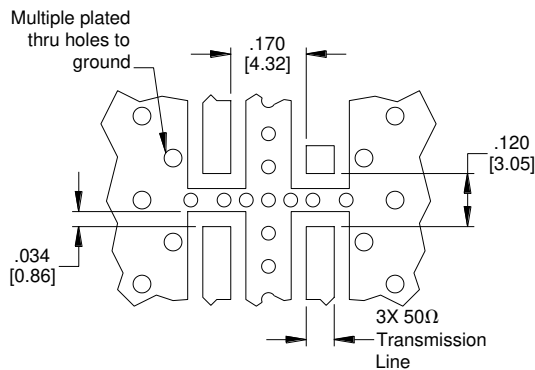
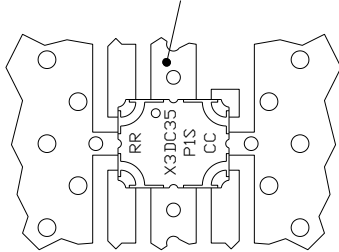

Dimensions are in Inches [Millimeters]
X3DC35P1S Mounting Footprint

Doherty Power handling

Doherty power amplifiers are capable of amplifying the signals of high Peak to Average Ratio (PAR) with high efficiency. A 1:1 symmetrical Doherty architecture is typically used for signals of 6-10dB PAR.

To evaluate power handling capability, the doherty combiner is analyzed in different conditions of varying PAR that the component would see in its lifetime.

Condition 1: In symmetrical Doherty application, at average power condition, the Doherty amplifier works at back off mode and turns on only main amplifier with half of its full power capacity. The thermal condition of Anaren Doherty combiner is evaluated as an impedance transformer.

X3DC35P1S can handle reliably for life 20 watts at main amplifier and 0 watts at peak amplifier when evaluated as impedance transformer.

Condition 2: Doherty amplifier ramps up the main amplifier to 65% its full power capacity and peak amplifier to 30% of its full power capacity, outputting power roughly 3dB above the average. The thermal condition of Anaren Doherty combiner is analyzed as a coherent combiner and such power level is assumed continuously over entire life span of the component. Although conservative and limit the components power rating, it is done so to guarantee the life time of the components over high PAR signals.

X3DC35P1S can handle reliably for life 26 watts at main amplifier and 12 watts at peak amplifier when evaluated for condition 2.

Condition 3: Signals of 3dB and above the average power occur with low probability and short duration and they do not present thermal risk. With high breakdown voltage, Anaren Doherty combiners can safely withstand at least 12dB peaks over the average rated power. X3DC35P1S can handle reliably for life 40 watts at main amplifier and 40 watts at peak amplifier when evaluated for peak pulses of very short duration.

The power handlings of Anaren Doherty combiners are conservatively rated at averaged power with high PAR signal and Doherty operation in mind. The combiners can be used in Doherty amplifiers of rated average output power. No further power derating for high PAR signals is required



Packaging and Ordering Information

Parts are available in reel. Packaging follows EIA 481-D. Parts are oriented in tape and reel as shown below. Minimum order quantities are 2000 per reel.

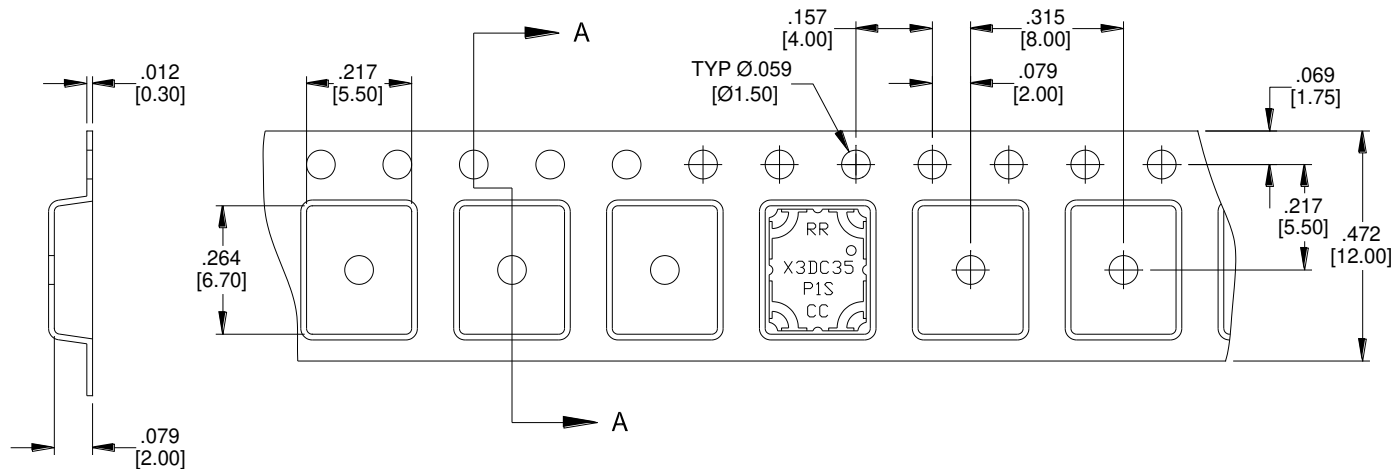

SECTION A-A

Dimensions are in Inches [Millimeters]

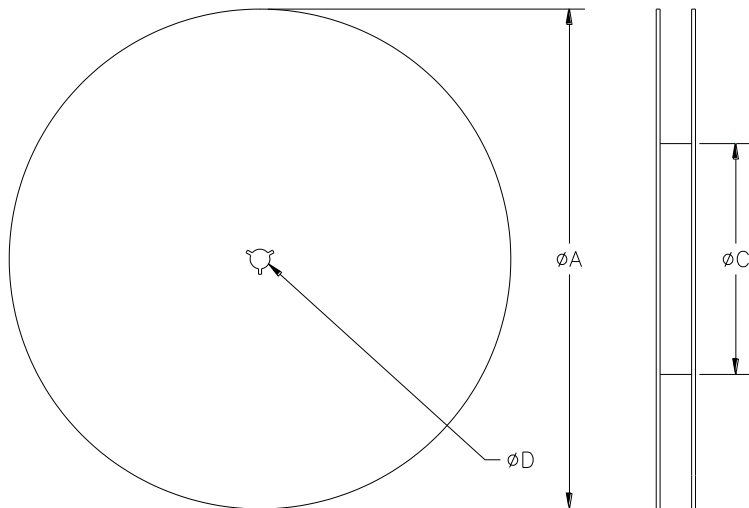
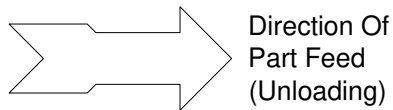

TABLE 1	
REEL DIMENSIONS (inches [mm])	
ϕA	13.0 [330.0]
B	.472 [12.0]
ϕC	4.017 [102.03]
ϕD	0.512 [13.0]

USA/Canada: (315) 432-8909
 Toll Free: (800) 411-6596
 Europe: +44 2392-232392

Available on Tape and Reel for Pick and Place Manufacturing.



Anaren®
 What'll we think of next?®