

776300-1 ✓ ACTIVE

AMP | AMPSEAL 16

TE Internal #: 776300-1

Automotive Terminals, Pin, Pin Diameter 1.59 mm [.063 in], 18 – 14 AWG Wire Size, .8 – 2 mm² Wire Size, Gold (Au) Interface Plating, AMPSEAL 16

[View on TE.com >](#)



Terminals & Splices > Automotive Terminals > Contacts: Size 16, 13A



Terminal Type: Pin

Mating Pin Diameter: 1.59 mm [.063 in]

Terminal Transmits: 0 – 24 A (Low Power)

Wire Size: .8 – 2 mm²

[All Contacts: Size 16, 13A \(33\)](#)

Features

Product Type Features

Sealable	No
----------	----

Contact Features

Contact Size	Size 16
Contact Fabrication	Stamped & Formed
Wire Contact Termination Area Plating Material	Tin
Crimp Type	F-Crimp
Terminal Type	Pin
Mating Pin Diameter	1.59 mm [.063 in]
Interface Plating	Gold (Au)

Termination Features

Termination Method to Wire & Cable	Crimp
Product Terminates To	Wire

Dimensions



Compatible Insulation Diameter Range	2.26 – 3.32 mm [.089 – .131 in]
Wire Size	.8 – 2 mm ²
Wire Size Search	14 AWG, 15 AWG, 16 AWG, 17 AWG, 18 AWG

Usage Conditions

Insulation Option	Uninsulated
-------------------	-------------

Operation/Application

Compatible With Wire Base Material	Copper
------------------------------------	--------

Packaging Features

Packaging Quantity	1000
Packaging Method	Bag

Other

Customer Preferred Contact	No
Terminal Transmits	0 – 24 A (Low Power)

Product Compliance

[For compliance documentation, visit the product page on TE.com>](#)

EU RoHS Directive 2011/65/EU	Compliant
EU ELV Directive 2000/53/EC	Compliant
China RoHS 2 Directive MIIT Order No 32, 2016	No Restricted Materials Above Threshold
EU REACH Regulation (EC) No. 1907/2006	Current ECHA Candidate List: JUNE 2023 (235) Candidate List Declared Against: JAN 2023 (233) Does not contain REACH SVHC
Halogen Content	Low Halogen - Br, Cl, F, I < 900 ppm per homogenous material. Also BFR/CFR/PVC Free
Solder Process Capability	Not applicable for solder process capability

Product Compliance Disclaimer

This information is provided based on reasonable inquiry of our suppliers and represents our current actual knowledge based on the information they provided. This information is subject to change. The part numbers that TE has identified as EU RoHS compliant have a maximum concentration of 0.1% by weight in homogenous materials for lead, hexavalent chromium, mercury, PBB, PBDE, DBP, BBP, DEHP, DIBP, and 0.01% for cadmium, or qualify for an exemption to these limits as defined in the Annexes of Directive 2011/65/EU (RoHS2). Finished electrical and electronic equipment products will be CE marked as required by Directive 2011/65/EU. Components may not be CE marked. Additionally, the part numbers that TE has identified as EU ELV compliant have a maximum concentration of 0.1% by weight in homogenous materials for lead, hexavalent chromium, and mercury, and 0.01% for cadmium, or qualify for an exemption to these limits as defined in the Annexes of Directive 2000/53/EC (ELV). Regarding the REACH Regulation, the information TE provides

on SVHC in articles for this part number is based on the latest European Chemicals Agency (ECHA) 'Guidance on requirements for substances in articles' posted at this URL: <https://echa.europa.eu/guidance-documents/guidance-on-reach>

Compatible Parts



TE Part # CAT-AM7801-CH8172
AMPSEAL 16 Housings



TE Part # 2320913-1
2POS,AMPSEAL 16,PIN HSG ASSY, SLD,COD 1



TE Part # 91337-1
SIZE 16 PRO-CRIMPER ASSY.

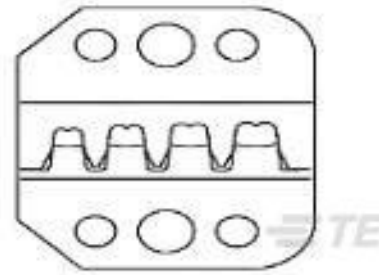

TE Part # 91337-2
SIZE 16 PRO-CRIMPER DIE



TE Part # 2320913-2
2POS,AMPSEAL 16,PIN HSG ASSY, SLD,COD 2



TE Part # 2320913-3
2POS,AMPSEAL 16,PIN HSG ASSY, SLD,COD 3



TE Part # 2320913-4
2POS,AMPSEAL 16,PIN HSG ASSY, SLD,COD 4

Also in the Series | AMPSEAL 16



Automotive Connector Caps & Covers (85)



Automotive Connector Locks & Position Assurance(2)

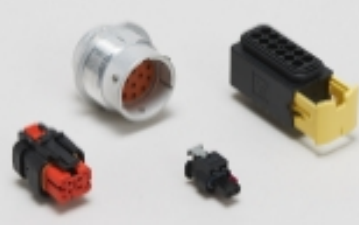

Automotive Housings(244)



Automotive Seals & Cavity Plugs(4)

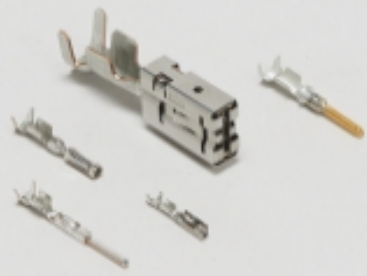

Automotive Terminals(33)

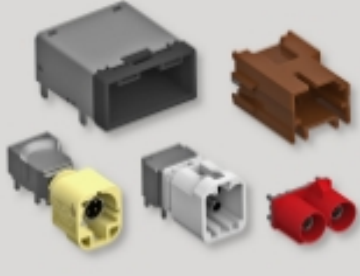

Data Connectivity Headers(2)



Data Connectivity Housings(3)



Other Automotive Connector Accessories(11)

Customers Also Bought



TE Part #HDP24-24-47SE
REC, 47P, BLK, E, 16/20, S



TE Part #6-1462037-6
IM46TS=IM RELAY 100mW 12V BIS



TE Part #776427-1
AMPSEAL 16 Housings



TE Part #776297-1
ASSEMBLY SOCKET LOOSE PC GOLD



TE Part #2292802-1
AS16 BACKSHELL, 12P PLUG,
SMOOTH EXIT, MC



TE Part #62050-1
110 FASTON REC 20-16 AWG TPBR

Documents

Product Drawings

PIN CONTACT WIRE TO WIRE LOOSE

English

CAD Files

Customer View Model

[ENG_CVM_776300-1_A.3d_igs.zip](#)

English

Customer View Model

[ENG_CVM_776300-1_A.3d_stp.zip](#)

English

Customer View Model

[ENG_CVM_776300-1_A.2d_dxf.zip](#)

English

3D PDF

English

By downloading the CAD file I accept and agree to the [Terms and Conditions](#) of use.

Datasheets & Catalog Pages

ICT Terminals and Connectors Catalogue

English

CONNECTOR SELECTOR

English

Product Specifications

Application Specification

English

776300-1

Automotive Terminals, Pin, Pin Diameter 1.59 mm [.063 in], 18 – 14 AWG Wire Size, .8 – 2 mm² Wire Size, Gold (Au) Interface Plating, AMPSEAL 16

