

## NEMA L14-20 Locking Receptacle

### Technical Datasheet

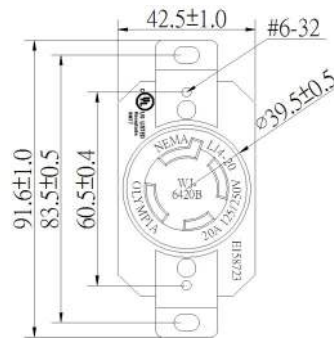

Product Specifications	
Product Item	Single Receptacle Locking Type
Rating	3 Pole, 4Wire Grounding 20A 125/250V AC
NEMA Configuration	L14-20R
Color	Black
Contact Material	All contact are brass, 0.050"(1.3m/m) thick.
Terminal Screw Material	#10 solid brass
Ground Screw Material	#10 solid brass (Green)
Cover ( Top ) Material	P.B.T. (Poly Butylene Terephthalate Resin) 94V-0
Base Material	P.B.T. (Poly Butylene Terephthalate Resin) 94V-0
Listings	UL/cUL E158723