

### General information

Part number	S32F1C-P19MFG0-3500
Termination	solder
Size	2
Locking principle	push
Coding	1_halfshell
Cable Diameter	cable_mini_35
Cable outlet	standard

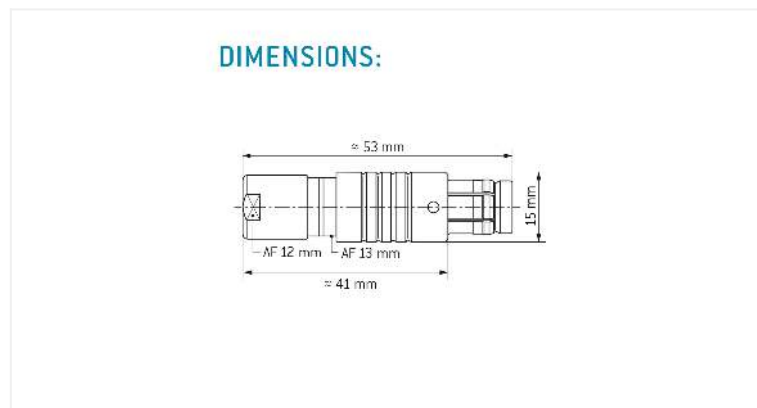

### Contact insert description

Number of contacts	19
Contact type	pins
Contact diameter	07mm
Insulator material	peek
Wire cross section	22_awg
Termination	solder
Termination diameter	085mm

reverse\_gender\_on\_request

### Technical information

Max. creepage and air clearance distance	05_mm	06_mm
Nominal current single contact	075_a	iec_60512_5_2
Nominal current insert	3,375 A	vde_0298_4
Test voltage	09_kv_ac	sae_13441

safety\_text

## Mechanical and environmental data

Degree of protection*	ip68
Operating temperature	40_120_c
Mating cycles	5000

mated

## Material and surface treatments

Housing	m_chrome
Contact	cu_alloy_gold

safety\_text\_2  
ul\_text  
illustrative\_text