

MMBT5401-G (PNP) RoHS Device

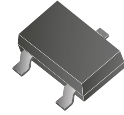

Features

- Epitaxial planar die construction.
- Complementary NPN type available (MMBT5551-G).
- Ideal for medium power amplification and switching.

Diagram:

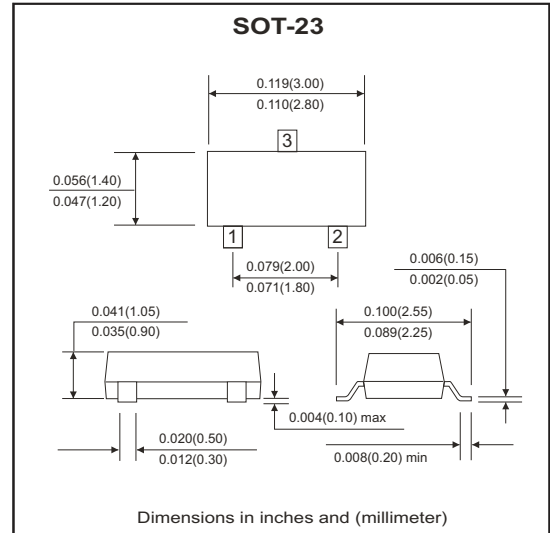
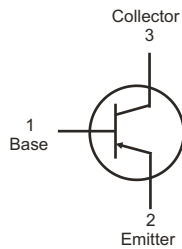

Marking: 2L

Maximum Ratings (at TA=25°C unless otherwise noted)

Parameter	Symbol	Value	Unit
Collector-base voltage	V_{CBO}	-160	V
Collector-emitter voltage	V_{CEO}	-150	V
Emitter-base voltage	V_{EBO}	-5	V
Collector current - continuous	I_C	-0.6	A
Collector dissipation	P_C	0.3	W
Junction and storage temperature	T_J, T_{STG}	-55 ~ +150	°C

Electrical Characteristics (at TA=25°C unless otherwise noted)

Parameter	Conditions	Symbol	Min	Max	Unit
Collector-base breakdown voltage	$I_C = -100\mu A, I_E = 0$	$V_{(BR)CBO}$	-160		V
Collector-emitter breakdown voltage	$I_C = -1mA, I_B = 0$	$V_{(BR)CEO}$	-150		V
Emitter-base breakdown voltage	$I_E = -10\mu A, I_C = 0$	$V_{(BR)EBO}$	-5		V
Collector cut-off current	$V_{CB} = -120V, I_E = 0$	I_{CBO}		-0.1	μA
Emitter cut-off current	$V_{EB} = -4V, I_C = 0$	I_{EBO}		-0.1	μA
DC current gain	$V_{CE} = -5V, I_C = -1mA$	$h_{FE(1)}$	80		
	$V_{CE} = -5V, I_C = -10mA$	$h_{FE(2)}$	100	200	
	$V_{CE} = -5V, I_C = -50mA$	$h_{FE(3)}$	50		
Collector-emitter saturation voltage	$I_C = -50mA, I_B = -5mA$	$V_{CE(sat)}$		-0.5	V
Base-emitter saturation voltage	$I_C = -50mA, I_B = -5mA$	$V_{BE(sat)}$		-1	V
Transition frequency	$V_{CE} = -5V, I_C = -10mA, f = 30MHz$	f_T	100		Mhz

RATING AND CHARACTERISTIC CURVES (MMBT5401-G)

Fig.1 Max Power Dissipation vs. Ambient Temperature

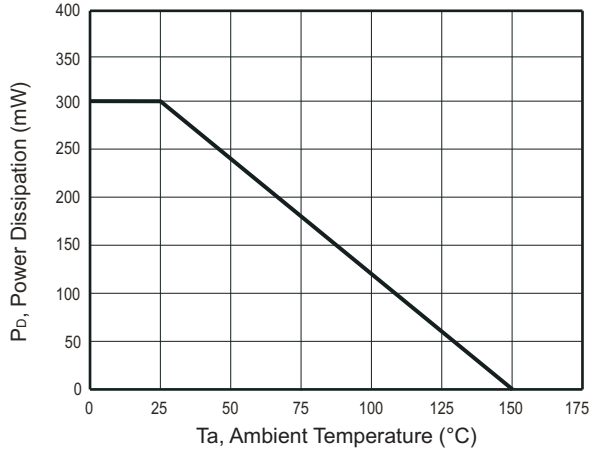

Fig.2 Collector Emitter Saturation Voltage vs. Collector Current

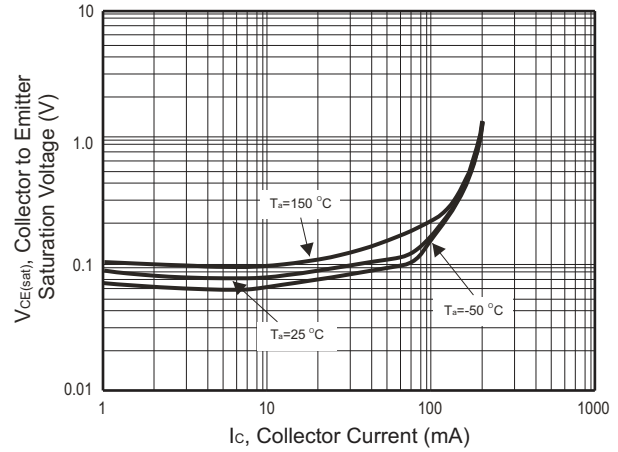

Fig.3 DC Current Gain vs. Collector Current

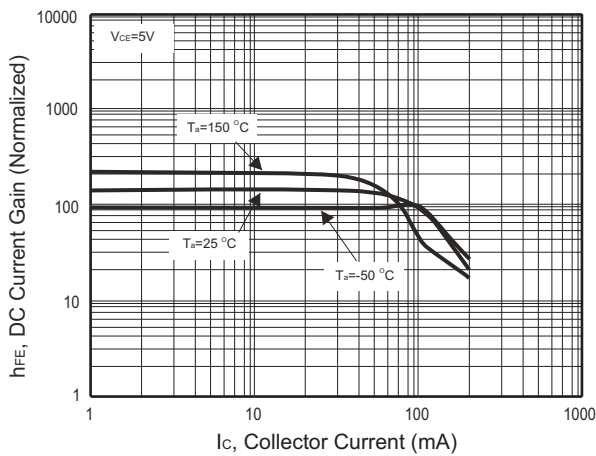

Fig.4 Base Emitter Voltage vs. Collector Current

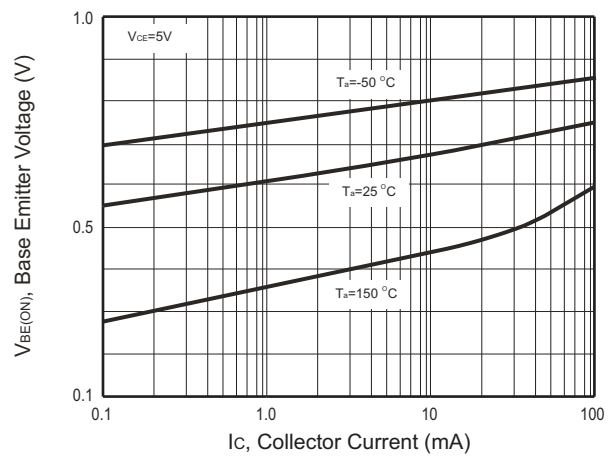
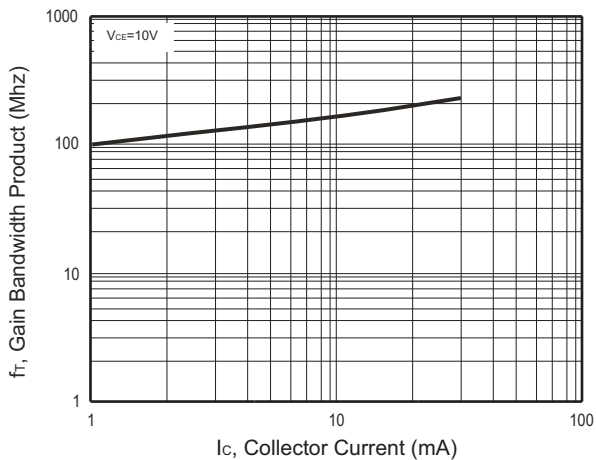
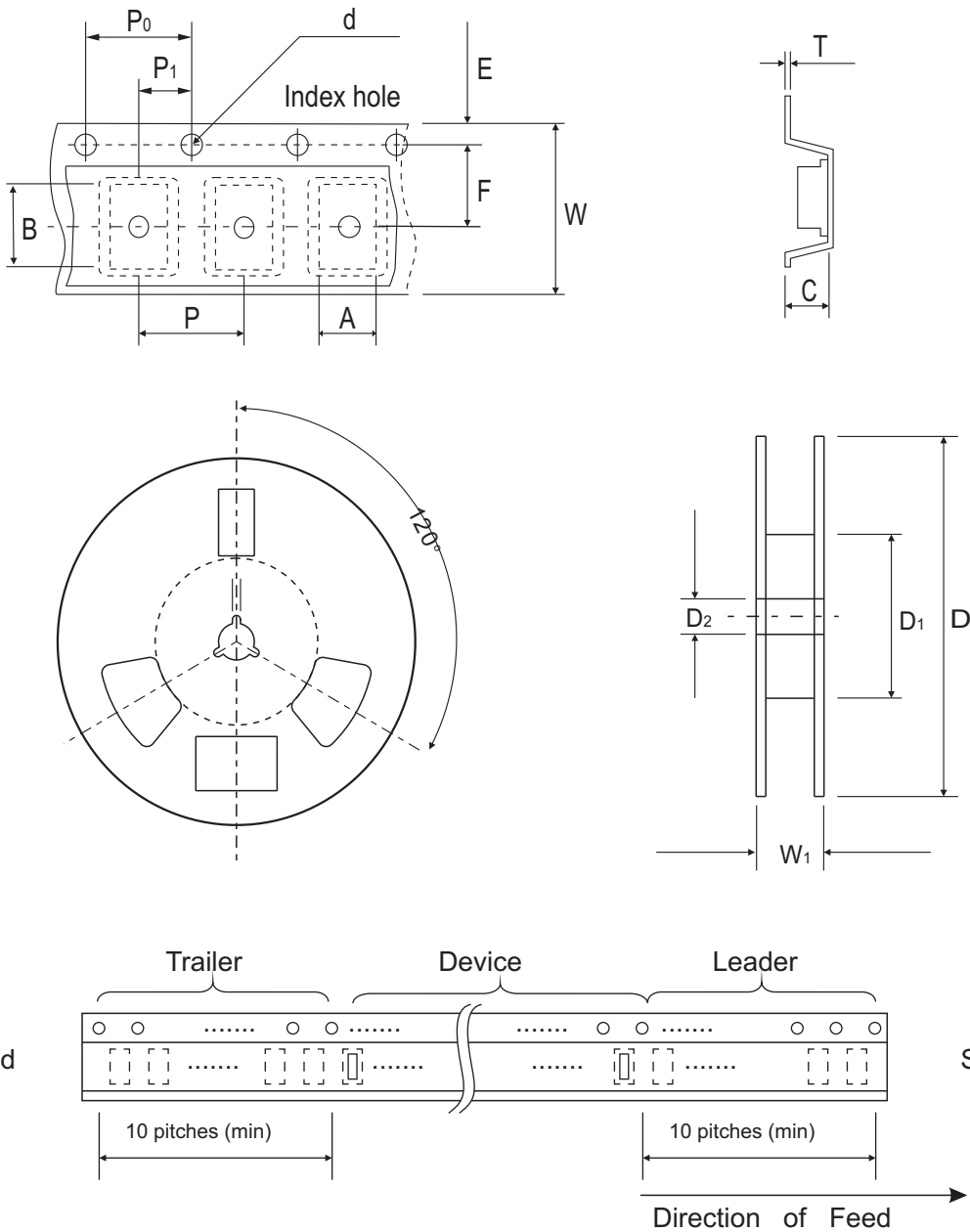

Fig.5 Gain Bandwidth Product vs. Collector Current



Reel Taping Specification



SOT-23	SYMBOL	A	B	C	d	D	D ₁	D ₂
	(mm)	3.10 ± 0.10	2.85 ± 0.10	1.40 ± 0.10	1.55 ± 0.10	178 ± 1	50.0 MIN.	13.0 ± 0.20
	(inch)	0.122 ± 0.004	0.112 ± 0.004	0.055 ± 0.004	0.061 ± 0.004	7.008 ± 0.04	1.969 MIN.	0.512 ± 0.008

SOT-23	SYMBOL	E	F	P	P ₀	P ₁	W	W ₁
	(mm)	1.75 ± 0.10	3.50 ± 0.05	4.00 ± 0.10	4.00 ± 0.10	2.00 ± 0.05	8.00 ± 0.30	14.4 MAX.
	(inch)	0.069 ± 0.004	0.138 ± 0.002	0.157 ± 0.004	0.157 ± 0.004	0.079 ± 0.002	0.315 ± 0.012	0.567 MAX.

Marking Code

Part Number	Marking Code
MMBT5401-G	2L

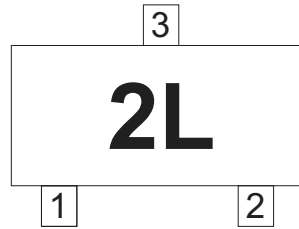

Suggested PAD Layout

SIZE	SOT-23	
	(mm)	(inch)
A	0.80	0.031
B	1.90	0.075
C	2.02	0.080
D	2.82	0.111

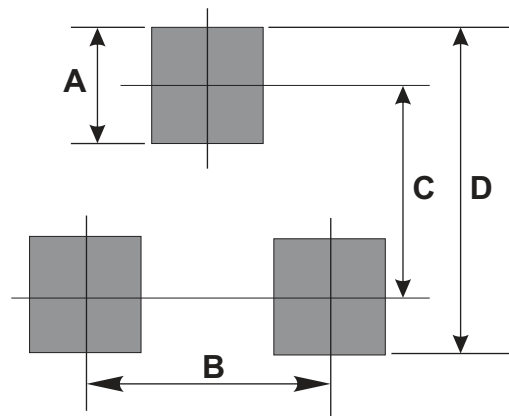

Standard Packaging

Case Type	REEL PACK	
	REEL (pcs)	Reel Size (inch)
SOT-23	3,000	7