

MR60BHA1

Respiratory Heartbeat Radar

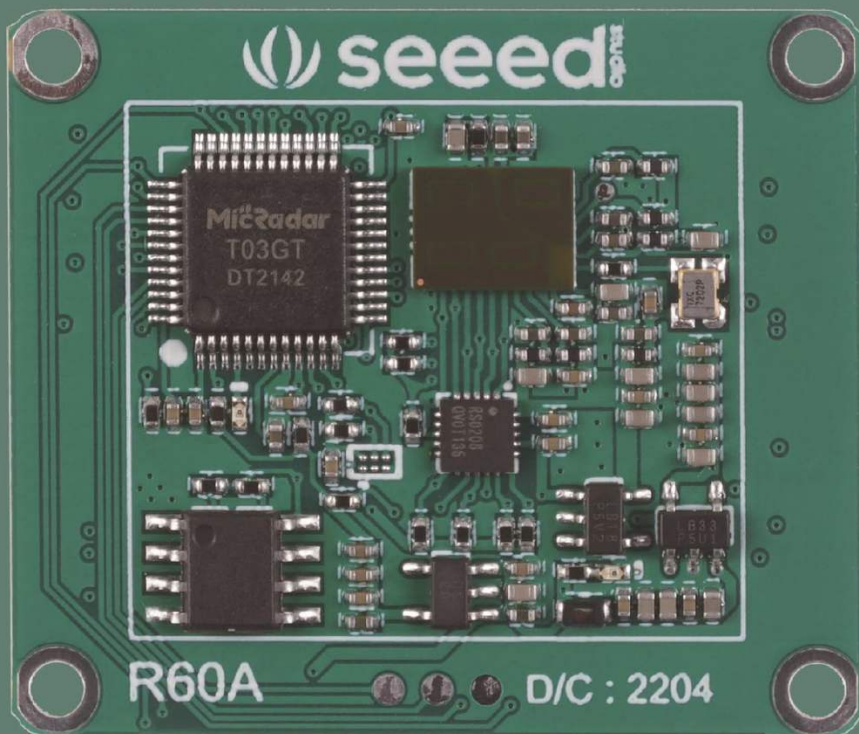

1. Overview

The MR60BHA1 radar module uses 60G millimetre wave radar technology to enable non-contact sensing of a person's breathing rate and heart rate.

This radar module has the following operating characteristics:

Implementation of radar detection based on FMCW FM continuous wave signals.

Realization of simultaneous sensing of human respiratory rate and heart rhythm.

Breathing heartbeat observation distance of 0.4-2 m

Low output power, which is not harmful to the human body

Independent of temperature, humidity, noise, airflow, dust, light and other environmental influences.

product support for secondary development, adaptable to a variety of scenarios applications.

Universal UART communication interface, providing a common protocol

4 groups of I/O reserved, according to user definition of input and output, or do simple interface simulation.

2. Main parameters

2.1. detection angle and distance

Parameter content	Minimum	Typical	Maximum	Unit
Performance				
Detection distance (thoracic)	0.4		2	m
Respiratory measurement accuracy		90		%
Heartbeat measurement accuracy		85		%
Refresh time	1		30	S
Observation set-up time		20		S

Parameter content	Minimum	Typical	Maximum	Unit
Operating parameters				
Operating voltage (VCC)	4.6	5	6	V
Operating current (ICC)		150		mA
Operating temperature (TOP)	-20		60	°C
Storage temperature (TST)	-40		80	°C
Launch parameters				
Operating frequency (fTX)	58	60	63.5	GHz
Transmitted power (Pout)		6		dBm
Antenna parameters				
Antenna gain (GANT)		4		dBi
Horizontal beam (-3dB)	-40		40	o
Vertical beam (-3dB)	-40		40	o

3. Module dimensions and pin description

3.1. Module size package

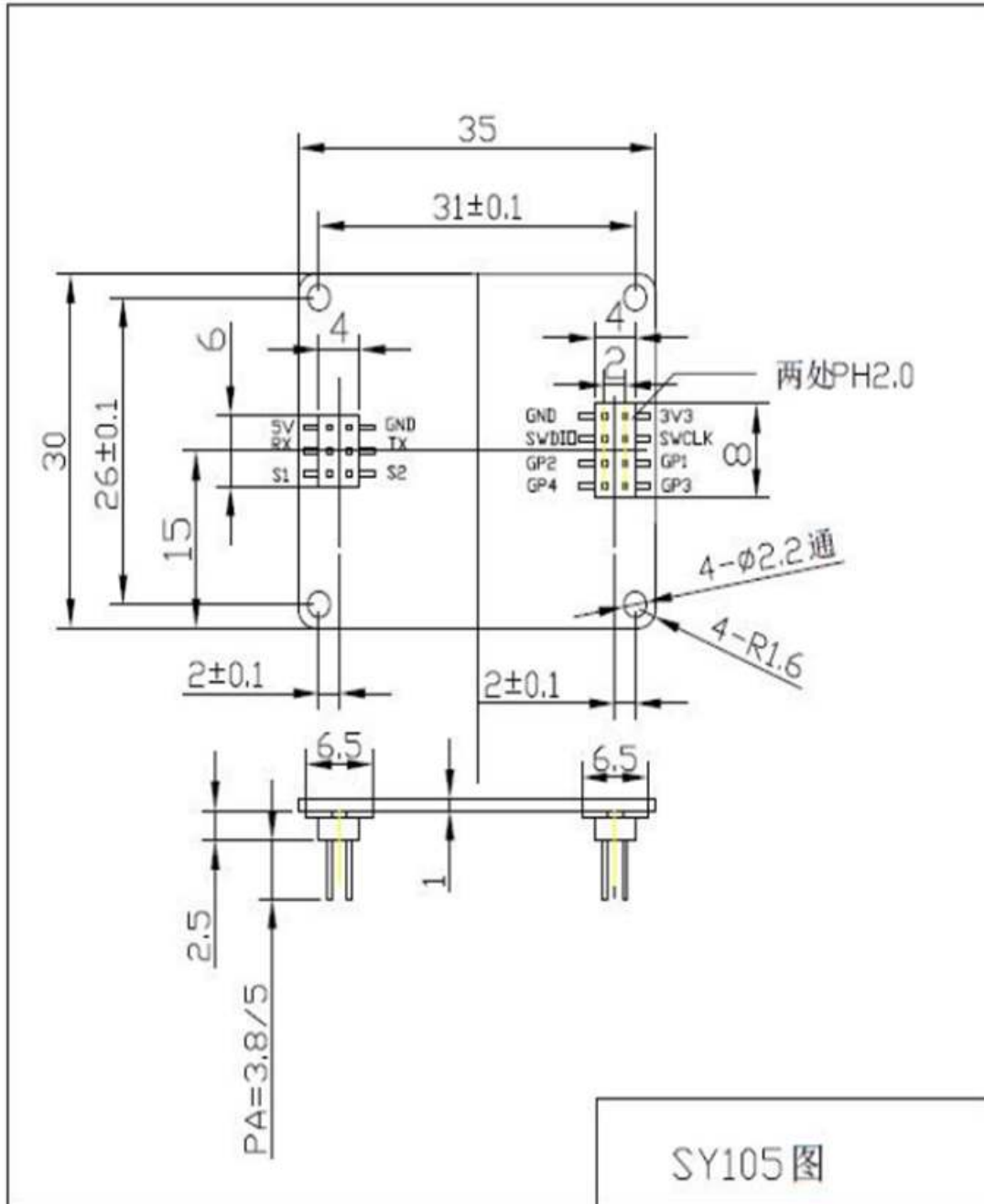

Fig. 1 Schematic diagram of the radar module structure

3.2. pin descriptions

Interface	Pins	Description	Typical values	Description
Interface 1	1	5V	5.0V	Positive power input
	2	GND		Ground
	3	RX		Serial port reception
	4	TX		Serial port send
	5	S1	3.3V/0V	occupied/unoccupied
	6	S2	3.3V.0V	Stationary / Active
Interface 2	1	3V3	3.3V	Output power
	2	GND		Ground
	3	SL		Reserved
	4	SD		Reserved
	5	GP1		Spare expansion pins
	6	GP2		Spare expansion pins
	7	GP3		Spare expansion pins
	8	GP4		Spare expansion pins

3.3. using the wiring diagram

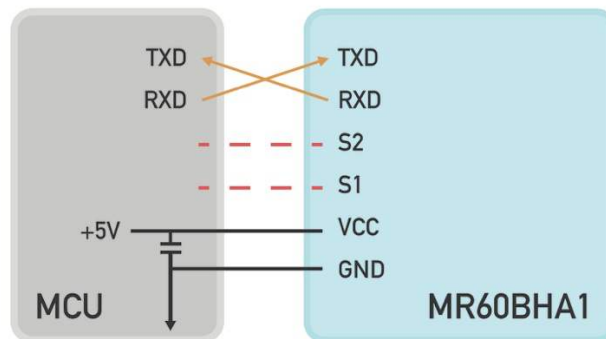
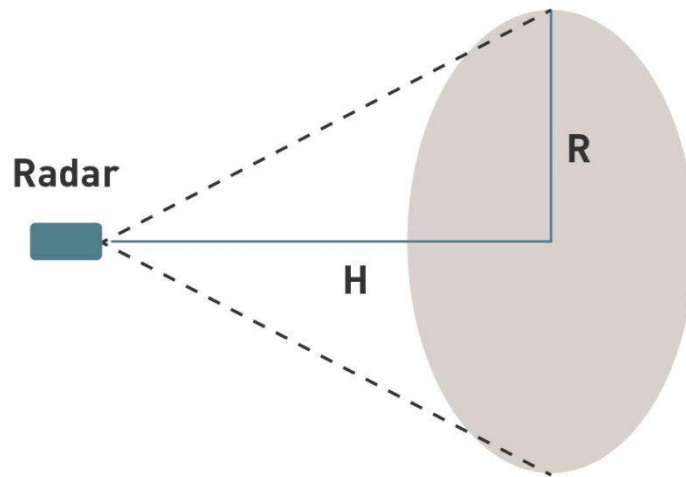

Fig. 2 Schematic diagram of the radar module and peripheral connections

4. Main operating properties

4.1 Radar module operating range

The radar module beam coverage is shown. The radar coverage is a three-dimensional sector of 80° horizontally and 80° tilted.



Due to the radar beam characteristics, the radar has a relatively long range in the direction normal to the antenna face, but a shorter range if it deviates from the antenna normal.

When the radar is mounted on top or at an angle, the radar beam range and the effective radiation space will reduce the radar range, which needs to be taken into account when using the radar.

4.2. main functions and performance

Main functions and performance

a. Breath detection function

a) Detection distance.

i. $0.4\text{m} \leq x \leq 2\text{m}$ // Detection distance between the chest cavity and the radar antenna surface

b) Accuracy rate: $\geq 90\%$

b. Heartbeat detection function

a) Detection distance

- i. $0.4\text{m} \leq x \leq 2\text{m}$ // Detection distance between the chest cavity and the radar antenna surface
 - b) Accuracy: $\geq 85\%$
 - c. Presence sensing function
 - a) Detection distance: $\leq 3\text{m}$ // distance between antenna face and person
 - b) Accuracy: $\geq 90\%$
 - d. Motion detection function
 - a) Motion triggering
 - b) Motion direction and position sensing

5. How the radar works and how it is installed

5.1. installation method

As the radar works mainly on the basis of the respiratory heart rhythm causing undulating movements on the surface of the large muscles, the undulation of the human chest and back will be more pronounced, so this radar needs to be installed in the correct position to the human chest or back.

Based on the radar mode of action, the following mounting options are considered for radar installation.

(1) Overhead installation

The radar beam is positioned vertically downwards towards the body, with the centre of the radar beam corresponding to the position of the body's chest cavity.

In this installation mode, a distance of $\leq 2\text{ m}$ is required between the radar and the body to be measured.

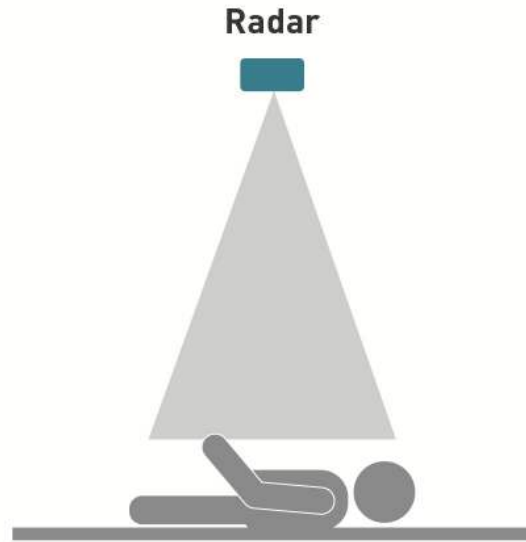

Fig. 5 Schematic diagram of the ceiling mount

(2) Tilt mounting

With tilt mounting, the radar is fixed to a wall or bedside, the radar is mounted at an angle (as shown in Fig. 6) and the radar beam is directed at the body at an angle, with the centre of the radar beam corresponding to the position of the human chest cavity.

In this installation mode, the radial distance between the radar and the body to be measured is ≤ 2 m.

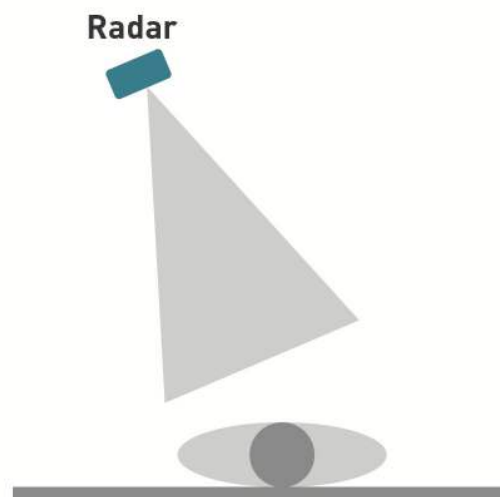

Fig. 6 Diagram of inclined installation

(3) Horizontal installation

The radar is placed horizontally (as shown in Fig. 7), the radar is fixed to a wall or placed on a table, the radar beam is directed towards the human body and the centre of the radar beam corresponds to the position of the human thorax.

The distance between the radar and the human body to be measured in this installation mode is ≤ 2 m.

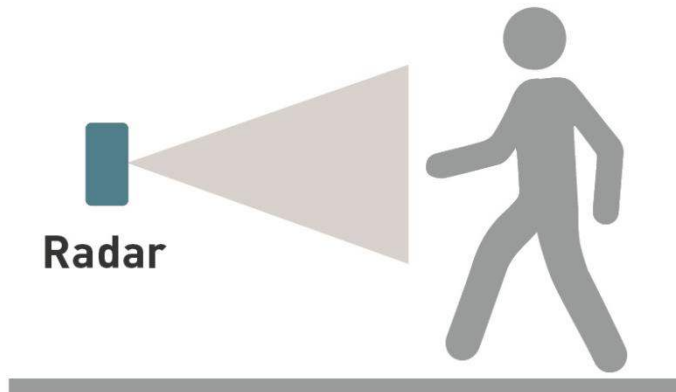

Fig. 7 Horizontal installation diagram



Fig. 8 Diagram of back mounting