



LPC2210/2220

16/32-bit ARM microcontrollers; flashless, with 10-bit ADC and external memory interface

Rev. 06 — 11 December 2008

Product data sheet

1. General description

The LPC2210/2220 microcontrollers are based on a 16/32-bit ARM7TDMI-S CPU with real-time emulation and embedded trace support. For critical code size applications, the alternative 16-bit Thumb mode reduces code by more than 30 % with minimal performance penalty.

With their 144-pin package, low power consumption, various 32-bit timers, 8-channel 10-bit ADC, PWM channels, and up to nine external interrupt pins these microcontrollers are particularly suitable for industrial control, medical systems, access control and point-of-sale. The LPC2210/2220 can provide up to 76 GPIOs depending on bus configuration. With a wide range of serial communications interfaces, it is also very well suited for communication gateways, protocol converters and embedded soft modems as well as many other general-purpose applications.

Remark: Throughout the data sheet, the term LPC2210/2220 will apply to devices with and without the /01 suffix. The /01 suffix will be used to differentiate LPC2210 devices only when necessary.

2. Features

2.1 Key features

- 16/32-bit ARM7TDMI-S microcontroller in a LQFP144 and TFBGA144 package.
- 16/64 kB on-chip static RAM (LPC2210/2220).
- Serial bootloader using UART0 provides in-system download and programming capabilities.
- EmbeddedICE-RT and Embedded Trace interfaces offer real-time debugging with the on-chip RealMonitor software as well as high-speed real-time tracing of instruction execution.
- Eight channel 10-bit ADC with conversion time as low as 2.44 μ s.
 - ◆ LPC2210/01 and LPC2220 only: Dedicated result registers for ADC(s) reduce interrupt overhead. The ADC pads are 5 V tolerant when configured for digital I/O function(s).
- Two 32-bit timers (LPC2220 and LPC2210/01 also external event counters) with four capture and four compare channels, PWM unit (six outputs), Real-Time Clock (RTC), and watchdog.
- Multiple serial interfaces including two UARTs (16C550), Fast I²C-bus (400 kbit/s) and two SPIs.
 - ◆ LPC2210/01 and LPC2220 only: A Synchronous Serial Port (SSP) with data buffers and variable length transfers can be selected to replace one SPI.

- ◆ LPC2210/01 and LPC2220 only: UART0/1 include fractional baud rate generator, auto-bauding capabilities, and handshake flow-control fully implemented in hardware.
- Vectored Interrupt Controller (VIC) with configurable priorities and vector addresses.
- Configurable external memory interface with up to four banks, each up to 16 MB and 8/16/32-bit data width.
- Up to 76 general purpose pins (5 V tolerant) capable. Up to nine edge/level sensitive external interrupt pins available.
 - ◆ LPC2210/01 and LPC2220 only: Fast GPIO ports enable port pin toggling up to 3.5 times faster than the original device. They also allow for a port pin to be read at any time regardless of its function.
- 60 MHz (LPC2210) and 75 MHz (LPC2210/01 and LPC2220) maximum CPU clock available from programmable on-chip Phase-Locked Loop (PLL) with settling time of 100 μs.
- On-chip integrated oscillator operates with external crystal in range of 1 MHz to 25 MHz and with external oscillator up to 25 MHz.
- Power saving modes include Idle and Power-down.
- Processor wake-up from Power-down mode via external interrupt.
- Individual enable/disable of peripheral functions for power optimization.
- Dual power supply:
 - ◆ CPU operating voltage range of 1.65 V to 1.95 V (1.8 V ± 0.15 V).
 - ◆ I/O power supply range of 3.0 V to 3.6 V (3.3 V ± 10 %) with 5 V tolerant I/O pads.

3. Ordering information

Table 1. Ordering information

| Type number | Package | | |
|------------------|----------|---|----------|
| | Name | Description | Version |
| LPC2210FBD144 | LQFP144 | plastic low profile quad flat package; 144 leads; body 20 × 20 × 1.4 mm | SOT486-1 |
| LPC2210FBD144/01 | LQFP144 | plastic low profile quad flat package; 144 leads; body 20 × 20 × 1.4 mm | SOT486-1 |
| LPC2220FBD144 | LQFP144 | plastic low profile quad flat package; 144 leads; body 20 × 20 × 1.4 mm | SOT486-1 |
| LPC2220FET144 | TFBGA144 | plastic thin fine-pitch ball grid array package; 144 balls; body 12 × 12 × 0.8 mm | SOT569-2 |
| LPC2220FET144/G | TFBGA144 | plastic thin fine-pitch ball grid array package; 144 balls; body 12 × 12 × 0.8 mm | SOT569-2 |

3.1 Ordering options

Table 2. Ordering options

| Type number | RAM | Fast GPIO/ SSP/ Enhanced UART, ADC, Timer | Temperature range |
|------------------|-------|---|-------------------|
| LPC2210FBD144 | 16 kB | no | -40 °C to +85 °C |
| LPC2210FBD144/01 | 16 kB | yes | -40 °C to +85 °C |
| LPC2220FBD144 | 64 kB | yes | -40 °C to +85 °C |
| LPC2220FET144 | 64 kB | yes | -40 °C to +85 °C |
| LPC2220FET144/G | 64 kB | yes | -40 °C to +85 °C |

4. Block diagram

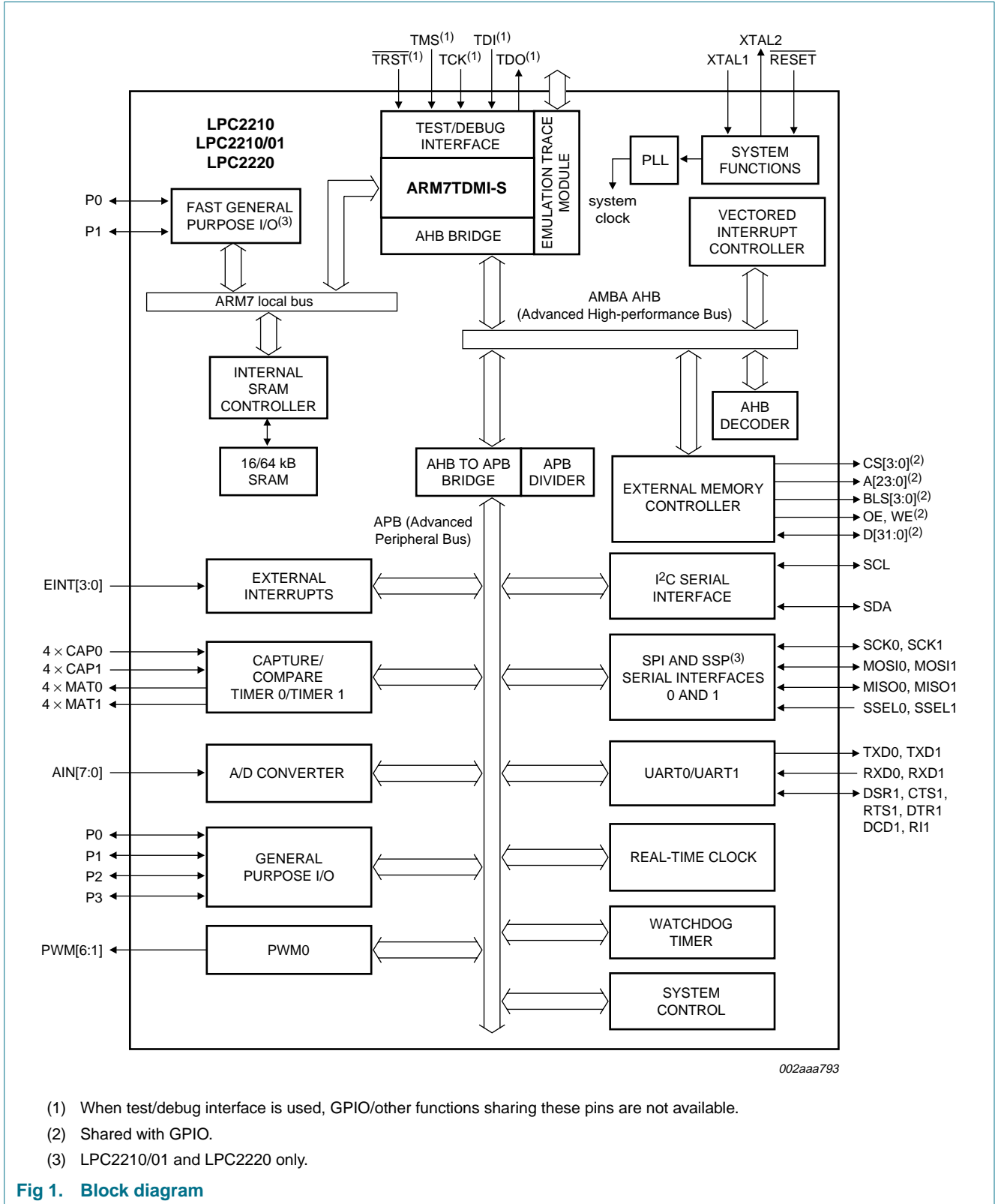

002aaa793

- (1) When test/debug interface is used, GPIO/other functions sharing these pins are not available.
- (2) Shared with GPIO.
- (3) LPC2210/01 and LPC2220 only.

Fig 1. Block diagram

5. Pinning information

5.1 Pinning

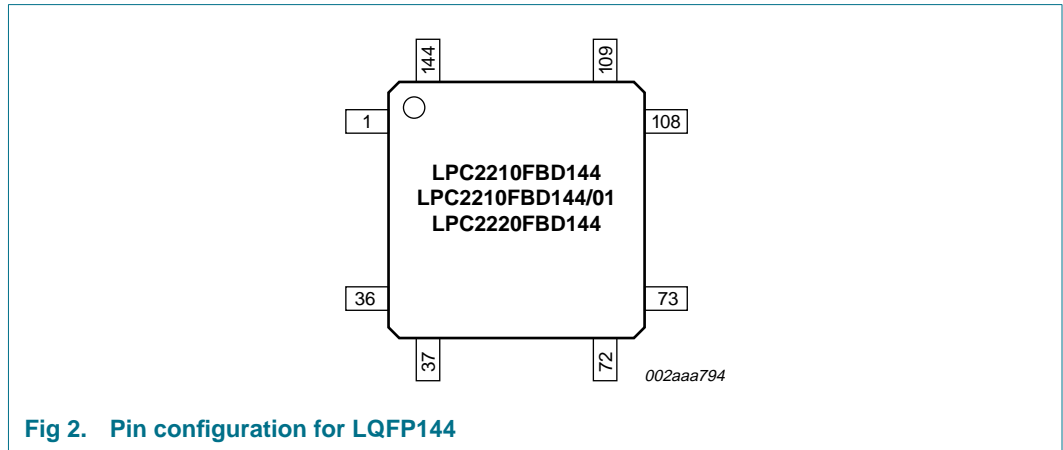

Fig 2. Pin configuration for LQFP144

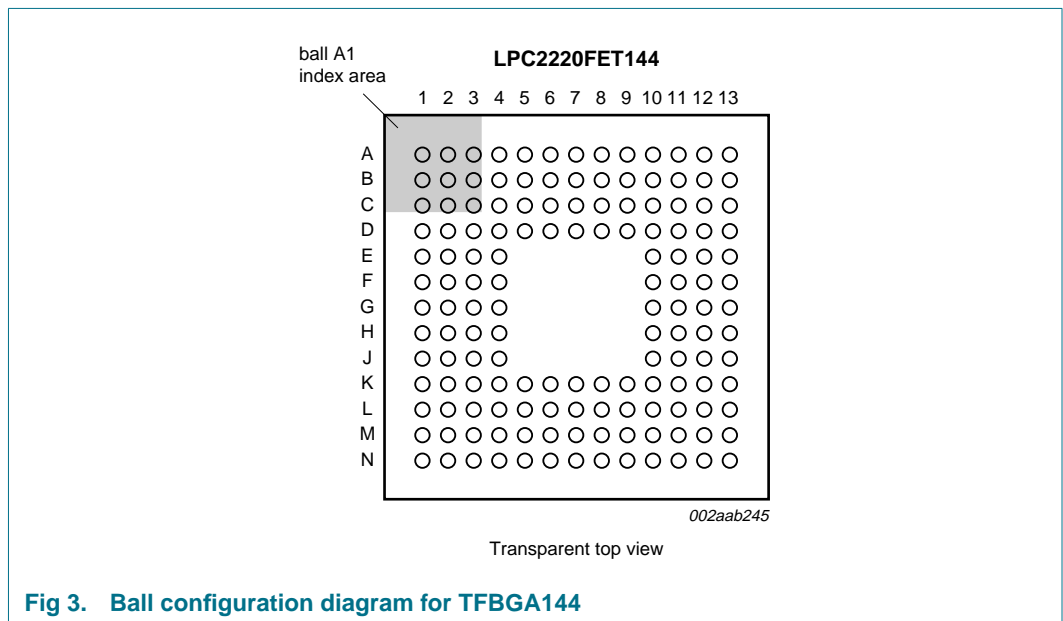

Fig 3. Ball configuration diagram for TFBGA144

Table 3. Ball allocation

| Row | Column | 1 | 2 | 3 | 4 | 5 | 6 | 7 | 8 | 9 | 10 | 11 | 12 | 13 |
|-----|--------------------------------------|-------------------------|--------------------------------------|-----------------------------|---------------|----------------------------------|-----------------|---------------------------------------|----------------------|---------------------------------------|---------------------------|---------------------------|--------------------------------------|----|
| A | P2.22/ D22 | V _{DDA(1V8)} | P1.28/ TDI | P2.21/ D21 | P2.18/ D18 | P2.14/ D14 | P1.29/ TCK | P2.11/ D11 | P2.10/ D10 | P2.7/D7 | V _{DD(3V3)} | V _{DD(1V8)} | P2.4/D4 | |
| B | V _{DD(3V3)} | P1.27/ TDO | XTAL2 | V _{SSA(PLL)} | P2.19/ D19 | P2.15/ D15 | P2.12/ D12 | P0.20/ MAT1.3/ SSEL1/ EINT3 | V _{DD(3V3)} | P2.6/D6 | V _{SS} | P2.3/D3 | V _{SS} | |
| C | P0.21/ PWM5/ CAP1.3 | V _{SS} | XTAL1 | V _{SSA} | RESET | P2.16/ D16 | P2.13/ D13 | P0.19/ MAT1.2/ MOSI1/ CAP1.2 | P2.9/D9 | P2.5/D5 | P2.2/D2 | P2.1/D1 | V _{DD(3V3)} | |
| D | P0.24 | P1.19/ TRACEP KT3 | P0.23 | P0.22/ CAP0.0/ MAT0.0 | P2.20/ D20 | P2.17/ D17 | V _{SS} | P0.18/ CAP1.3/ MISO1/ MAT1.3 | P2.8/D8 | P1.30/ TMS | V _{SS} | P1.20/ TRACES YNC | P0.17/ CAP1.2/ SCK1/ MAT1.2 | |
| E | P2.25/ D25 | P2.24/ D24 | P2.23/ D23 | V _{SS} | | | | | | P0.16/ EINT0/ MAT0.2/ CAP0.2 | P0.15/ RI1/ EINT2 | P2.0/D0 | P3.30/ BLS1 | |
| F | P2.27/ D27/ BOOT1 | P1.18/ TRACEP KT2 | V _{DDA(3V3)} | P2.26/ D26/ BOOT0 | | | | | | P3.31/ BLS0 | P1.21/ PIPESTAT 0 | V _{DD(3V3)} | V _{SS} | |
| G | P2.29/ D29 | P2.28/ D28 | P2.30/ D30/AIN4 | P2.31/ D31/AIN5 | | | | | | P0.14/ DCD1/ EINT1 | P1.0/CS0 | P3.0/A0 | P1.1/OE | |
| H | P0.25 | n.c. | P0.27/ AIN0/ CAP0.1/ MAT0.1 | P1.17/ TRACEP KT1 | | | | | | P0.13/ DTR1/ MAT1.1 | P1.22/ PIPESTAT 1 | P3.2/A2 | P3.1/A1 | |
| J | P0.28/ AIN1/ CAP0.2/ MAT0.2 | V _{SS} | P3.29/ BLS2/ AIN6 | P3.28/ BLS3/ AIN7 | | | | | | P3.3/A3 | P1.23/ PIPESTAT 2 | P0.11/ CTS1/ CAP1.1 | P0.12/ DSR1/ MAT1.0 | |
| K | P3.27/WE | P3.26/ CS1 | V _{DD(3V3)} | P3.22/ A22 | P3.20/ A20 | P0.1/ RXD0/ PWM3/ EINT0 | P3.14/ A14 | P1.25/ EXTIN0 | P3.11/ A11 | V _{DD(3V3)} | P0.10/ RTS1/ CAP1.0 | V _{SS} | P3.4/A4 | |

Table 3. Ball allocation ...continued

| Row | Column | 1 | 2 | 3 | 4 | 5 | 6 | 7 | 8 | 9 | 10 | 11 | 12 | 13 |
|-----|--------|--------------------------------------|-------------------------------------|-------------------------|------------------------|---------------|-------------------------|-----------------|-----------------------------------|---------------------------|-----------------|-----------------------------------|------------------------|----------------------------------|
| L | | P0.29/ AIN2/ CAP0.3/ MAT0.3 | P0.30/ AIN3/ EINT3/ CAP0.0 | P1.16/ TRACEP KT0 | P0.0/ TXD0/ PWM1 | P3.19/ A19 | P0.2/ SCL/ CAP0.0 | P3.15/ A15 | P0.4/ SCK0/ CAP0.1 | P3.12/ A12 | V _{SS} | P1.24/ TRACEC LK | P0.8/ TXD1/ PWM4 | P0.9/ RXD1/ PWM6/ EINT3 |
| M | | P3.25/ CS2 | P3.24/ CS3 | V _{DD(3V3)} | P1.31/ TRST | P3.18/ A18 | V _{DD(3V3)} | P3.16/ A16 | P0.3/ SDA/ MAT0.0/ EINT1 | P3.13/ A13 | P3.9/A9 | P0.7/ SSEL0/ PWM2/ EINT2 | P3.7/A7 | P3.5/A5 |
| N | | V _{DD(1V8)} | V _{SS} | P3.23/ A23/ XCLK | P3.21/ A21 | P3.17/ A17 | P1.26/ RTCK | V _{SS} | V _{DD(3V3)} | P0.5/ MISO0/ MAT0.1 | P3.10/ A10 | P0.6/ MOSI0/ CAP0.2 | P3.8/A8 | P3.6/A6 |

5.2 Pin description

Table 4. Pin description

| Symbol | Pin (LQFP) | Pin (TFBGA) | Type | Description |
|---------------------------|-------------------|--------------------|------|---|
| P0.0 to P0.31 | | | I/O | Port 0: Port 0 is a 32-bit bidirectional I/O port with individual direction controls for each bit. The operation of port 0 pins depends upon the pin function selected via the Pin Connect Block. Pins 26 and 31 of port 0 are not available. |
| P0.0/TXD0/ PWM1 | 42 ^[1] | L4 ^[1] | O | TXD0 — Transmitter output for UART0. |
| | | | O | PWM1 — Pulse Width Modulator output 1. |
| P0.1/RXD0/ PWM3/EINT0 | 49 ^[2] | K6 ^[2] | I | RXD0 — Receiver input for UART0. |
| | | | O | PWM3 — Pulse Width Modulator output 3. |
| | | | I | EINT0 — External interrupt 0 input |
| P0.2/SCL/ CAP0.0 | 50 ^[3] | L6 ^[3] | I/O | SCL — I ² C-bus clock input/output. Open-drain output (for I ² C-bus compliance). |
| | | | I | CAP0.0 — Capture input for Timer 0, channel 0. |
| P0.3/SDA/ MAT0.0/EINT1 | 58 ^[3] | M8 ^[3] | I/O | SDA — I ² C-bus data input/output. Open-drain output (for I ² C-bus compliance). |
| | | | O | MAT0.0 — Match output for Timer 0, channel 0. |
| | | | I | EINT1 — External interrupt 1 input. |
| P0.4/SCK0/ CAP0.1 | 59 ^[1] | L8 ^[1] | I/O | SCK0 — Serial clock for SPI0. SPI clock output from master or input to slave. |
| | | | I | CAP0.1 — Capture input for Timer 0, channel 1. |
| P0.5/MISO0/ MAT0.1 | 61 ^[1] | N9 ^[1] | I/O | MISO0 — Master In Slave OUT for SPI0. Data input to SPI master or data output from SPI slave. |
| | | | O | MAT0.1 — Match output for Timer 0, channel 1. |
| P0.6/MOSI0/ CAP0.2 | 68 ^[1] | N11 ^[1] | I/O | MOSI0 — Master Out Slave In for SPI0. Data output from SPI master or data input to SPI slave. |
| | | | I | CAP0.2 — Capture input for Timer 0, channel 2. |
| P0.7/SSEL0/ PWM2/EINT2 | 69 ^[2] | M11 ^[2] | I | SSEL0 — Slave Select for SPI0. Selects the SPI interface as a slave. |
| | | | O | PWM2 — Pulse Width Modulator output 2. |
| | | | I | EINT2 — External interrupt 2 input. |
| P0.8/TXD1/ PWM4 | 75 ^[1] | L12 ^[1] | O | TXD1 — Transmitter output for UART1. |
| | | | O | PWM4 — Pulse Width Modulator output 4. |
| P0.9/RXD1/ PWM6/EINT3 | 76 ^[2] | L13 ^[2] | I | RXD1 — Receiver input for UART1. |
| | | | O | PWM6 — Pulse Width Modulator output 6. |
| | | | I | EINT3 — External interrupt 3 input. |
| P0.10/RTS1/ CAP1.0 | 78 ^[1] | K11 ^[1] | O | RTS1 — Request to Send output for UART1. |
| | | | I | CAP1.0 — Capture input for Timer 1, channel 0. |
| P0.11/CTS1/ CAP1.1 | 83 ^[1] | J12 ^[1] | I | CTS1 — Clear to Send input for UART1. |
| | | | I | CAP1.1 — Capture input for Timer 1, channel 1. |
| P0.12/DSR1/ MAT1.0 | 84 ^[1] | J13 ^[1] | I | DSR1 — Data Set Ready input for UART1. |
| | | | O | MAT1.0 — Match output for Timer 1, channel 0. |

Table 4. Pin description ...continued

| Symbol | Pin (LQFP) | Pin (TFBGA) | Type | Description |
|-------------------------------|--------------------|--------------------|------|--|
| P0.13/DTR1/ MAT1.1 | 85 ^[1] | H10 ^[1] | O | DTR1 — Data Terminal Ready output for UART1. |
| | | | O | MAT1.1 — Match output for Timer 1, channel 1. |
| P0.14/DCD1/ EINT1 | 92 ^[2] | G10 ^[2] | I | DCD1 — Data Carrier Detect input for UART1. |
| | | | I | EINT1 — External interrupt 1 input. Note: LOW on this pin while RESET is LOW forces on-chip bootloader to take over control of the part after reset. |
| P0.15/RI1/ EINT2 | 99 ^[2] | E11 ^[2] | I | RI1 — Ring Indicator input for UART1. |
| | | | I | EINT2 — External interrupt 2 input. |
| P0.16/EINT0/ MAT0.2/CAP0.2 | 100 ^[2] | E10 ^[2] | I | EINT0 — External interrupt 0 input. |
| | | | O | MAT0.2 — Match output for Timer 0, channel 2. |
| | | | I | CAP0.2 — Capture input for Timer 0, channel 2. |
| P0.17/CAP1.2/ SCK1/MAT1.2 | 101 ^[1] | D13 ^[1] | I | CAP1.2 — Capture input for Timer 1, channel 2. |
| | | | I/O | SCK1 — Serial Clock for SPI1/SSI/Microwire. SPI/SSI/Microwire clock output from master or input to slave. |
| | | | O | MAT1.2 — Match output for Timer 1, channel 2. |
| P0.18/CAP1.3/ MISO1/MAT1.3 | 121 ^[1] | D8 ^[1] | I | CAP1.3 — Capture input for Timer 1, channel 3. |
| | | | I/O | MISO1 — Master In Slave Out for SPI1. Data input to SPI master or data output from SPI slave. |
| | | | O | MAT1.3 — Match output for Timer 1, channel 3. |
| P0.19/MAT1.2/ MOSI1/CAP1.2 | 122 ^[1] | C8 ^[1] | O | MAT1.2 — Match output for Timer 1, channel 2. |
| | | | I/O | MOSI1 — Master Out Slave In for SPI1. Data output from SPI master or data input to SPI slave. <ul style="list-style-type: none"> • SPI interface: MOSI line. • SSI: DX/RX line (SPI1 as a master/slave). • Microwire: SO/SI line (SPI1 as a master/slave). |
| | | | I | CAP1.2 — Capture input for Timer 1, channel 2. |
| | | | O | MAT1.3 — Match output for Timer 1, channel 3. |
| P0.20/MAT1.3/ SSEL1/ EINT3 | 123 ^[2] | B8 ^[2] | O | MAT1.3 — Match output for Timer 1, channel 3. |
| | | | I | SSEL1 — Slave Select for SPI1/Microwire. Used to select the SPI or Microwire interface as a slave. Frame synchronization in case of 4-wire SSI. |
| | | | I | EINT3 — External interrupt 3 input. |
| P0.21/PWM5/ CAP1.3 | 4 ^[1] | C1 ^[1] | O | PWM5 — Pulse Width Modulator output 5. |
| | | | I | CAP1.3 — Capture input for Timer 1, channel 3. |
| P0.22/CAP0.0/ MAT0.0 | 5 ^[1] | D4 ^[1] | I | CAP0.0 — Capture input for Timer 0, channel 0. |
| | | | O | MAT0.0 — Match output for Timer 0, channel 0. |
| P0.23 | 6 ^[1] | D3 ^[1] | I/O | General purpose bidirectional digital port only. |
| P0.24 | 8 ^[1] | D1 ^[1] | I/O | General purpose bidirectional digital port only. |
| P0.25 | 21 ^[1] | H1 ^[1] | I/O | General purpose bidirectional digital port only. |
| P0.27/AIN0/ CAP0.1/MAT0.1 | 23 ^[4] | H3 ^[4] | I | AIN0 — ADC, input 0. This analog input is always connected to its pin. |
| | | | I | CAP0.1 — Capture input for Timer 0, channel 1. |
| | | | O | MAT0.1 — Match output for Timer 0, channel 1. |

Table 4. Pin description ...continued

| Symbol | Pin (LQFP) | Pin (TFBGA) | Type | Description |
|------------------------------|--------------------|--------------------|------|--|
| P0.28/AIN1/ CAP0.2/MAT0.2 | 25 ^[4] | J1 ^[4] | I | AIN1 — ADC, input 1. This analog input is always connected to its pin. |
| | | | I | CAP0.2 — Capture input for Timer 0, channel 2. |
| | | | O | MAT0.2 — Match output for Timer 0, channel 2. |
| P0.29/AIN2/ CAP0.3/MAT0.3 | 32 ^[4] | L1 ^[4] | I | AIN2 — ADC, input 2. This analog input is always connected to its pin. |
| | | | I | CAP0.3 — Capture input for Timer 0, Channel 3. |
| | | | O | MAT0.3 — Match output for Timer 0, channel 3. |
| P0.30/AIN3/ EINT3/CAP0.0 | 33 ^[4] | L2 ^[4] | I | AIN3 — ADC, input 3. This analog input is always connected to its pin. |
| | | | I | EINT3 — External interrupt 3 input. |
| | | | I | CAP0.0 — Capture input for Timer 0, channel 0. |
| P1.0 to P1.31 | | | I/O | Port 1: Port 1 is a 32-bit bidirectional I/O port with individual direction controls for each bit. The operation of port 1 pins depends upon the pin function selected via the Pin Connect Block. Pins 0 through 15 of port 1 are not available. |
| P1.0/ $\overline{CS0}$ | 91 ^[5] | G11 ^[5] | O | $\overline{CS0}$ — LOW-active Chip Select 0 signal. (Bank 0 addresses range 0x8000 0000 to 0x80FF FFFF) |
| P1.1/ \overline{OE} | 90 ^[5] | G13 ^[5] | O | \overline{OE} — LOW-active Output Enable signal. |
| P1.16/ TRACEPKT0 | 34 ^[5] | L3 ^[5] | O | TRACEPKT0 — Trace Packet, bit 0. Standard I/O port with internal pull-up. |
| P1.17/ TRACEPKT1 | 24 ^[5] | H4 ^[5] | O | TRACEPKT1 — Trace Packet, bit 1. Standard I/O port with internal pull-up. |
| P1.18/ TRACEPKT2 | 15 ^[5] | F2 ^[5] | O | TRACEPKT2 — Trace Packet, bit 2. Standard I/O port with internal pull-up. |
| P1.19/ TRACEPKT3 | 7 ^[5] | D2 ^[5] | O | TRACEPKT3 — Trace Packet, bit 3. Standard I/O port with internal pull-up. |
| P1.20/ TRACESYNC | 102 ^[5] | D12 ^[5] | O | TRACESYNC — Trace Synchronization. Standard I/O port with internal pull-up. Note: LOW on this pin while \overline{RESET} is LOW, enables pins P1[25:16] to operate as Trace port after reset. |
| P1.21/ PIPESTAT0 | 95 ^[5] | F11 ^[5] | O | PIPESTAT0 — Pipeline Status, bit 0. Standard I/O port with internal pull-up. |
| P1.22/ PIPESTAT1 | 86 ^[5] | H11 ^[5] | O | PIPESTAT1 — Pipeline Status, bit 1. Standard I/O port with internal pull-up. |
| P1.23/ PIPESTAT2 | 82 ^[5] | J11 ^[5] | O | PIPESTAT2 — Pipeline Status, bit 2. Standard I/O port with internal pull-up. |
| P1.24/ TRACECLK | 70 ^[5] | L11 ^[5] | O | TRACECLK — Trace Clock. Standard I/O port with internal pull-up. |
| P1.25/EXTIN0 | 60 ^[5] | K8 ^[5] | I | EXTIN0 — External Trigger Input. Standard I/O with internal pull-up. |

Table 4. Pin description ...continued

| Symbol | Pin (LQFP) | Pin (TFBGA) | Type | Description |
|---------------------------------|--------------------|--------------------|------|---|
| P1.26/RTCK | 52 ^[5] | N6 ^[5] | I/O | RTCK — Returned Test Clock output. Extra signal added to the JTAG port. Assists debugger synchronization when processor frequency varies. Bidirectional pin with internal pull-up. Note: LOW on this pin while $\overline{\text{RESET}}$ is LOW, enables pins P1[31:26] to operate as Debug port after reset. |
| P1.27/TDO | 144 ^[5] | B2 ^[5] | O | TDO — Test Data out for JTAG interface. |
| P1.28/TDI | 140 ^[5] | A3 ^[5] | I | TDI — Test Data in for JTAG interface. |
| P1.29/TCK | 126 ^[5] | A7 ^[5] | I | TCK — Test Clock for JTAG interface. This clock must be slower than $\frac{1}{6}$ of the CPU clock (CCLK) for the JTAG interface to operate. |
| P1.30/TMS | 113 ^[5] | D10 ^[5] | I | TMS — Test Mode Select for JTAG interface. |
| P1.31/ $\overline{\text{TRST}}$ | 43 ^[5] | M4 ^[5] | I | $\overline{\text{TRST}}$ — Test Reset for JTAG interface. |
| P2.0 to P2.31 | | | I/O | Port 2 — Port 2 is a 32-bit bidirectional I/O port with individual direction controls for each bit. The operation of port 2 pins depends upon the pin function selected via the Pin Connect Block. |
| P2.0/D0 | 98 ^[5] | E12 ^[5] | I/O | D0 — External memory data line 0. |
| P2.1/D1 | 105 ^[5] | C12 ^[5] | I/O | D1 — External memory data line 1. |
| P2.2/D2 | 106 ^[5] | C11 ^[5] | I/O | D2 — External memory data line 2. |
| P2.3/D3 | 108 ^[5] | B12 ^[5] | I/O | D3 — External memory data line 3. |
| P2.4/D4 | 109 ^[5] | A13 ^[5] | I/O | D4 — External memory data line 4. |
| P2.5/D5 | 114 ^[5] | C10 ^[5] | I/O | D5 — External memory data line 5. |
| P2.6/D6 | 115 ^[5] | B10 ^[5] | I/O | D6 — External memory data line 6. |
| P2.7/D7 | 116 ^[5] | A10 ^[5] | I/O | D7 — External memory data line 7. |
| P2.8/D8 | 117 ^[5] | D9 ^[5] | I/O | D8 — External memory data line 8. |
| P2.9/D9 | 118 ^[5] | C9 ^[5] | I/O | D9 — External memory data line 9. |
| P2.10/D10 | 120 ^[5] | A9 ^[5] | I/O | D10 — External memory data line 10. |
| P2.11/D11 | 124 ^[5] | A8 ^[5] | I/O | D11 — External memory data line 11. |
| P2.12/D12 | 125 ^[5] | B7 ^[5] | I/O | D12 — External memory data line 12. |
| P2.13/D13 | 127 ^[5] | C7 ^[5] | I/O | D13 — External memory data line 13. |
| P2.14/D14 | 129 ^[5] | A6 ^[5] | I/O | D14 — External memory data line 14. |
| P2.15/D15 | 130 ^[5] | B6 ^[5] | I/O | D15 — External memory data line 15. |
| P2.16/D16 | 131 ^[5] | C6 ^[5] | I/O | D16 — External memory data line 16. |
| P2.17/D17 | 132 ^[5] | D6 ^[5] | I/O | D17 — External memory data line 17. |
| P2.18/D18 | 133 ^[5] | A5 ^[5] | I/O | D18 — External memory data line 18. |
| P2.19/D19 | 134 ^[5] | B5 ^[5] | I/O | D19 — External memory data line 19. |
| P2.20/D20 | 136 ^[5] | D5 ^[5] | I/O | D20 — External memory data line 20. |
| P2.21/D21 | 137 ^[5] | A4 ^[5] | I/O | D21 — External memory data line 21. |
| P2.22/D22 | 1 ^[5] | A1 ^[5] | I/O | D22 — External memory data line 22. |
| P2.23/D23 | 10 ^[5] | E3 ^[5] | I/O | D23 — External memory data line 23. |
| P2.24/D24 | 11 ^[5] | E2 ^[5] | I/O | D24 — External memory data line 24. |
| P2.25/D25 | 12 ^[5] | E1 ^[5] | I/O | D25 — External memory data line 25. |

Table 4. Pin description ...continued

| Symbol | Pin (LQFP) | Pin (TFBGA) | Type | Description |
|---------------------|-------------------|--------------------|----------|--|
| P2.26/D26/ BOOT0 | 13 ^[5] | F4 ^[5] | I/O I | D26 — External memory data line 26. BOOT0 — While $\overline{\text{RESET}}$ is LOW, together with BOOT1 controls booting and internal operation. Internal pull-up ensures HIGH state if pin is left unconnected. |
| P2.27/D27/ BOOT1 | 16 ^[5] | F1 ^[5] | I/O I | D27 — External memory data line 27. BOOT1 — While $\overline{\text{RESET}}$ is LOW, together with BOOT0 controls booting and internal operation. Internal pull-up ensures HIGH state if pin is left unconnected. BOOT1:0 = 00 selects 8-bit memory on $\overline{\text{CS0}}$ for boot. BOOT1:0 = 01 selects 16-bit memory on $\overline{\text{CS0}}$ for boot. BOOT1:0 = 10 selects 32-bit memory on $\overline{\text{CS0}}$ for boot. BOOT1:0 = 11 selects 16-bit memory on $\overline{\text{CS0}}$ for boot. |
| P2.28/D28 | 17 ^[5] | G2 ^[5] | I/O | D28 — External memory data line 28. |
| P2.29/D29 | 18 ^[5] | G1 ^[5] | I/O | D29 — External memory data line 29. |
| P2.30/D30/ AIN4 | 19 ^[2] | G3 ^[2] | I/O I | D30 — External memory data line 30. AIN4 — ADC, input 4. This analog input is always connected to its pin. |
| P2.31/D31/ AIN5 | 20 ^[2] | G4 ^[2] | I/O I | D31 — External memory data line 31. AIN5 — ADC, input 5. This analog input is always connected to its pin. |
| P3.0 to P3.31 | | | I/O | Port 3 — Port 3 is a 32-bit bidirectional I/O port with individual direction controls for each bit. The operation of port 3 pins depends upon the pin function selected via the Pin Connect Block. |
| P3.0/A0 | 89 ^[5] | G12 ^[5] | O | A0 — External memory address line 0. |
| P3.1/A1 | 88 ^[5] | H13 ^[5] | O | A1 — External memory address line 1. |
| P3.2/A2 | 87 ^[5] | H12 ^[5] | O | A2 — External memory address line 2. |
| P3.3/A3 | 81 ^[5] | J10 ^[5] | O | A3 — External memory address line 3. |
| P3.4/A4 | 80 ^[5] | K13 ^[5] | O | A4 — External memory address line 4. |
| P3.5/A5 | 74 ^[5] | M13 ^[5] | O | A5 — External memory address line 5. |
| P3.6/A6 | 73 ^[5] | N13 ^[5] | O | A6 — External memory address line 6. |
| P3.7/A7 | 72 ^[5] | M12 ^[5] | O | A7 — External memory address line 7. |
| P3.8/A8 | 71 ^[5] | N12 ^[5] | O | A8 — External memory address line 8. |
| P3.9/A9 | 66 ^[5] | M10 ^[5] | O | A9 — External memory address line 9. |
| P3.10/A10 | 65 ^[5] | N10 ^[5] | O | A10 — External memory address line 10. |
| P3.11/A11 | 64 ^[5] | K9 ^[5] | O | A11 — External memory address line 11. |
| P3.12/A12 | 63 ^[5] | L9 ^[5] | O | A12 — External memory address line 12. |
| P3.13/A13 | 62 ^[5] | M9 ^[5] | O | A13 — External memory address line 13. |
| P3.14/A14 | 56 ^[5] | K7 ^[5] | O | A14 — External memory address line 14. |
| P3.15/A15 | 55 ^[5] | L7 ^[5] | O | A15 — External memory address line 15. |
| P3.16/A16 | 53 ^[5] | M7 ^[5] | O | A16 — External memory address line 16. |
| P3.17/A17 | 48 ^[5] | N5 ^[5] | O | A17 — External memory address line 17. |
| P3.18/A18 | 47 ^[5] | M5 ^[5] | O | A18 — External memory address line 18. |

Table 4. Pin description ...continued

| Symbol | Pin (LQFP) | Pin (TFBGA) | Type | Description |
|---|---|--|--------|--|
| P3.19/A19 | 46 ^[5] | L5 ^[5] | O | A19 — External memory address line 19. |
| P3.20/A20 | 45 ^[5] | K5 ^[5] | O | A20 — External memory address line 20. |
| P3.21/A21 | 44 ^[5] | N4 ^[5] | O | A21 — External memory address line 21. |
| P3.22/A22 | 41 ^[5] | K4 ^[5] | O | A22 — External memory address line 22. |
| P3.23/A23/ XCLK | 40 ^[5] | N3 ^[5] | O O | A23 — External memory address line 23. XCLK — Clock output. |
| P3.24/ $\overline{\text{CS3}}$ | 36 ^[5] | M2 ^[5] | O | $\overline{\text{CS3}}$ — LOW-active Chip Select 3 signal. (Bank 3 addresses range 0x8300 0000 to 0x83FF FFFF) |
| P3.25/ $\overline{\text{CS2}}$ | 35 ^[5] | M1 ^[5] | O | $\overline{\text{CS2}}$ — LOW-active Chip Select 2 signal. (Bank 2 addresses range 0x8200 0000 to 0x82FF FFFF) |
| P3.26/ $\overline{\text{CS1}}$ | 30 ^[5] | K2 ^[5] | O | $\overline{\text{CS1}}$ — LOW-active Chip Select 1 signal. (Bank 1 addresses range 0x8100 0000 to 0x81FF FFFF) |
| P3.27/ $\overline{\text{WE}}$ | 29 ^[5] | K1 ^[5] | O | $\overline{\text{WE}}$ — LOW-active Write enable signal. |
| P3.28/ $\overline{\text{BLS3}}$ / AIN7 | 28 ^[2] | J4 ^[2] | O I | $\overline{\text{BLS3}}$ — LOW-active Byte Lane Select signal (Bank 3). AIN7 — ADC, input 7. This analog input is always connected to its pin. |
| P3.29/ $\overline{\text{BLS2}}$ / AIN6 | 27 ^[4] | J3 ^[4] | O I | $\overline{\text{BLS2}}$ — LOW-active Byte Lane Select signal (Bank 2). AIN6 — ADC, input 6. This analog input is always connected to its pin. |
| P3.30/ $\overline{\text{BLS1}}$ | 97 ^[4] | E13 ^[4] | O | $\overline{\text{BLS1}}$ — LOW-active Byte Lane Select signal (Bank 1). |
| P3.31/ $\overline{\text{BLS0}}$ | 96 ^[4] | F10 ^[4] | O | $\overline{\text{BLS0}}$ — LOW-active Byte Lane Select signal (Bank 0). |
| n.c. | 22 ^[5] | H2 ^[5] | | Not connected. This pin MUST NOT be pulled LOW or the device might not operate properly. |
| $\overline{\text{RESET}}$ | 135 ^[6] | C5 ^[6] | I | External reset input: A LOW on this pin resets the device, causing I/O ports and peripherals to take on their default states, and processor execution to begin at address 0. TTL with hysteresis, 5 V tolerant. |
| XTAL1 | 142 ^[7] | C3 ^[7] | I | Input to the oscillator circuit and internal clock generator circuits. |
| XTAL2 | 141 ^[7] | B3 ^[7] | O | Output from the oscillator amplifier. |
| V _{SS} | 3, 9, 26, 38, 54, 67, 79, 93, 103, 107, 111, 128 | C2, E4, J2, N2, N7, L10, K12, F13, D11, B13, B11, D7 | I | Ground: 0 V reference. |
| V _{SSA} | 139 | C4 | I | Analog ground: 0 V reference. This should nominally be the same voltage as V _{SS} , but should be isolated to minimize noise and error. |
| V _{SSA(PLL)} | 138 | B4 | I | PLL analog ground: 0 V reference. This should nominally be the same voltage as V _{SS} , but should be isolated to minimize noise and error. |
| V _{DD(1V8)} | 37, 110 | N1, A12 | I | 1.8 V core power supply: This is the power supply voltage for internal circuitry. |

Table 4. Pin description ...continued

| Symbol | Pin (LQFP) | Pin (TFBGA) | Type | Description |
|----------------|--|---|------|--|
| $V_{DDA(1V8)}$ | 143 | A2 | I | Analog 1.8 V core power supply: This is the power supply voltage for internal circuitry. This should be nominally the same voltage as $V_{DD(1V8)}$ but should be isolated to minimize noise and error. |
| $V_{DD(3V3)}$ | 2, 31, 39, 51, 57, 77, 94, 104, 112, 119 | B1, K3, M3, M6, N8, K10, F12, C13, A11, B9 | I | 3.3 V pad power supply: This is the power supply voltage for the I/O ports. |
| $V_{DDA(3V3)}$ | 14 | F3 | I | Analog 3.3 V pad power supply: This should be nominally the same voltage as $V_{DD(3V3)}$ but should be isolated to minimize noise and error. |

- [1] 5 V tolerant pad providing digital I/O functions with TTL levels and hysteresis and 10 ns slew rate control.
- [2] 5 V tolerant pad providing digital I/O functions with TTL levels and hysteresis and 10 ns slew rate control. If configured for an input function, this pad utilizes built-in glitch filter that blocks pulses shorter than 3 ns.
- [3] Open drain 5 V tolerant digital I/O I²C-bus 400 kHz specification compatible pad. It requires external pull-up to provide an output functionality.
- [4] 5 V tolerant pad providing digital I/O (with TTL levels and hysteresis and 10 ns slew rate control) and analog input function. If configured for a digital input function, this pad utilizes built-in glitch filter that blocks pulses shorter than 3 ns. When configured as an ADC input, digital section of the pad is disabled.
- [5] 5 V tolerant pad with built-in pull-up resistor providing digital I/O functions with TTL levels and hysteresis and 10 ns slew rate control. The pull-up resistor's value ranges from 60 k Ω to 300 k Ω .
- [6] 5 V tolerant pad providing digital input (with TTL levels and hysteresis) function only.
- [7] Pad provides special analog functionality.

6. Functional description

6.1 Architectural overview

The ARM7TDMI-S is a general purpose 32-bit microprocessor, which offers high performance and very low power consumption. The ARM architecture is based on RISC principles, and the instruction set and related decode mechanism are much simpler than those of microprogrammed CISC. This simplicity results in a high instruction throughput and impressive real-time interrupt response from a small and cost-effective processor core.

Pipeline techniques are employed so that all parts of the processing and memory systems can operate continuously. Typically, while one instruction is being executed, its successor is being decoded, and a third instruction is being fetched from memory.

The ARM7TDMI-S processor also employs a unique architectural strategy known as Thumb, which makes it ideally suited to high-volume applications with memory restrictions, or applications where code density is an issue.

The key idea behind Thumb is that of a super-reduced instruction set. Essentially, the ARM7TDMI-S processor has two instruction sets:

- The standard 32-bit ARM set.
- A 16-bit Thumb set.

The Thumb set's 16-bit instruction length allows it to approach twice the density of standard ARM code while retaining most of the ARM's performance advantage over a traditional 16-bit processor using 16-bit registers. This is possible because Thumb code operates on the same 32-bit register set as ARM code.

Thumb code is able to provide up to 65 % of the code size of ARM, and 160 % of the performance of an equivalent ARM processor connected to a 16-bit memory system.

6.2 On-chip SRAM

On-chip SRAM may be used for code and/or data storage. The SRAM may be accessed as 8-bit, 16-bit, and 32-bit. The LPC2210 and LPC2210/01 provide 16 kB of static RAM, and the LPC2220 provides 64 kB of static RAM.

6.3 Memory map

The LPC2210/2220 memory maps incorporate several distinct regions, as shown in [Figure 4](#).

In addition, the CPU interrupt vectors may be re-mapped to allow them to reside in either on-chip bootloader, external memory BANK0 or on-chip static RAM. This is described in [Section 6.20 "System control"](#).

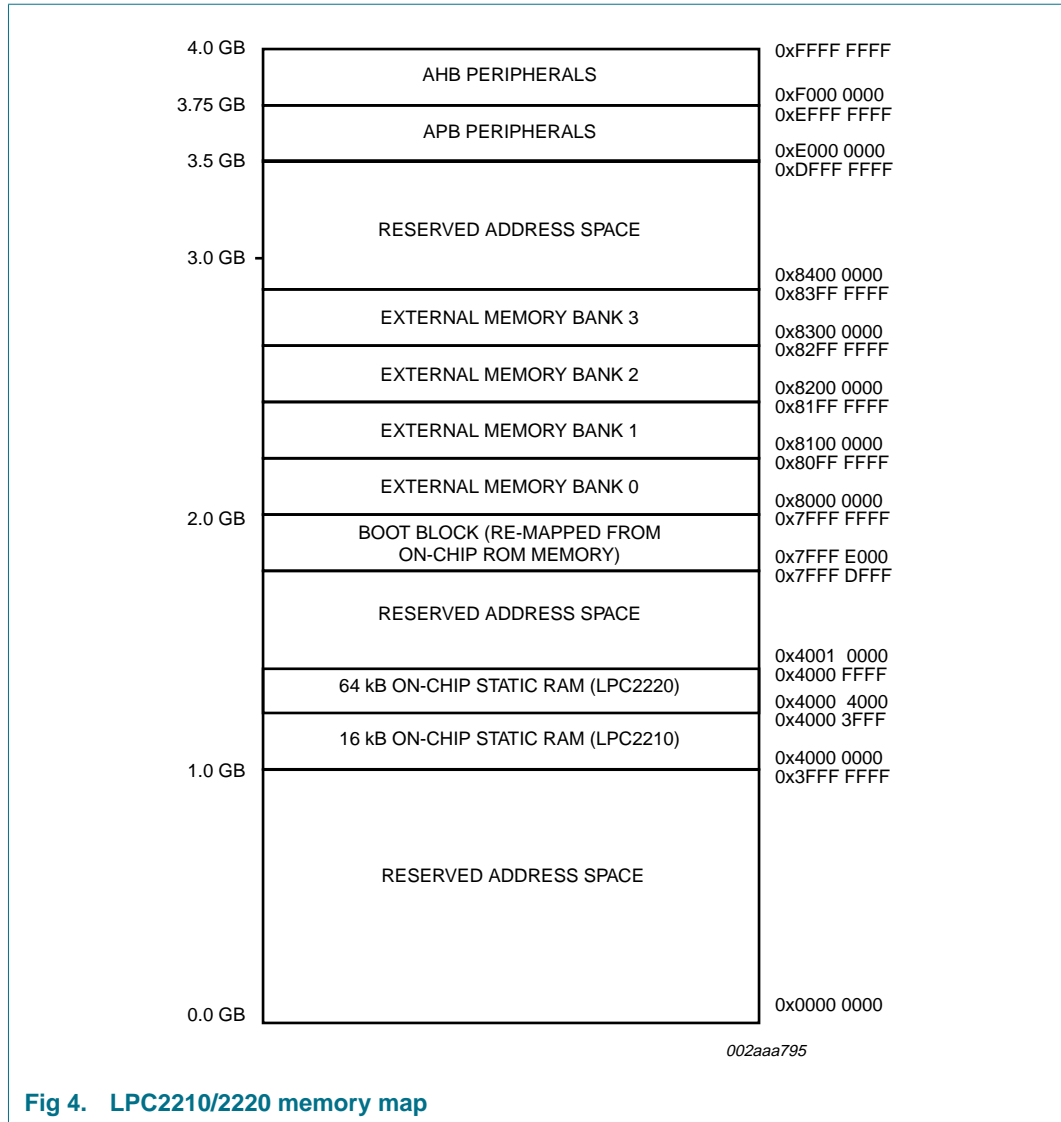

Fig 4. LPC2210/2220 memory map

6.4 Interrupt controller

The VIC accepts all of the interrupt request inputs and categorizes them as Fast Interrupt Request (FIQ), vectored Interrupt Request (IRQ), and non-vectored IRQ as defined by programmable settings. The programmable assignment scheme means that priorities of interrupts from the various peripherals can be dynamically assigned and adjusted.

FIQ has the highest priority. If more than one request is assigned to FIQ, the VIC combines the requests to produce the FIQ signal to the ARM processor. The fastest possible FIQ latency is achieved when only one request is classified as FIQ, because then the FIQ service routine can simply start dealing with that device. But if more than one request is assigned to the FIQ class, the FIQ service routine can read a word from the VIC that identifies which FIQ source(s) is (are) requesting an interrupt.

Vectored IRQs have the middle priority. Sixteen of the interrupt requests can be assigned to this category. Any of the interrupt requests can be assigned to any of the 16 vectored IRQ slots, among which slot 0 has the highest priority and slot 15 has the lowest.

Non-vectored IRQs have the lowest priority.

The VIC combines the requests from all the vectored and non-vectored IRQs to produce the IRQ signal to the ARM processor. The IRQ service routine can start by reading a register from the VIC and jumping there. If any of the vectored IRQs are requesting, the VIC provides the address of the highest-priority requesting IRQs service routine, otherwise it provides the address of a default routine that is shared by all the non-vectored IRQs. The default routine can read another VIC register to see what IRQs are active.

6.4.1 Interrupt sources

Table 5 lists the interrupt sources for each peripheral function. Each peripheral device has one interrupt line connected to the VIC, but may have several internal interrupt flags. Individual interrupt flags may also represent more than one interrupt source.

Table 5. Interrupt sources

| Block | Flag(s) | VIC channel # |
|------------------|---|---------------|
| WDT | Watchdog Interrupt (WDINT) | 0 |
| - | Reserved for software interrupts only | 1 |
| ARM Core | EmbeddedICE, DbgCommRX | 2 |
| ARM Core | EmbeddedICE, DbgCommTX | 3 |
| TIMER0 | Match 0 to 3 (MR0, MR1, MR2, MR3) | 4 |
| TIMER1 | Match 0 to 3 (MR0, MR1, MR2, MR3) | 5 |
| UART0 | RX Line Status (RLS) Transmit Holding Register Empty (THRE) RX Data Available (RDA) Character Time-out Indicator (CTI) | 6 |
| UART1 | RX Line Status (RLS) Transmit Holding Register empty (THRE) RX Data Available (RDA) Character Time-out Indicator (CTI) Modem Status Interrupt (MSI) | 7 |
| PWM0 | Match 0 to 6 (MR0, MR1, MR2, MR3, MR4, MR5, MR6) | 8 |
| I ² C | SI (state change) | 9 |
| SPI0 | SPIF, MODF | 10 |
| SPI1 and SSP | SPIF, MODF and TXRIS, RXRIS, RTRIS, RORRIS | 11 |
| PLL | PLL Lock (PLOCK) | 12 |
| RTC | RTCCIF (Counter Increment), RTCALF (Alarm) | 13 |
| System Control | External Interrupt 0 (EINT0) | 14 |
| | External Interrupt 1 (EINT1) | 15 |
| | External Interrupt 2 (EINT2) | 16 |
| | External Interrupt 3 (EINT3) | 17 |
| A/D | ADC | 18 |

6.5 Pin connect block

The pin connect block allows selected pins of the microcontroller to have more than one function. Configuration registers control the multiplexers to allow connection between the pin and the on chip peripherals. Peripherals should be connected to the appropriate pins prior to being activated, and prior to any related interrupt(s) being enabled. Activity of any enabled peripheral function that is not mapped to a related pin should be considered undefined.

The pin control module contains three registers as shown in [Table 6](#).

Table 6. Pin control module registers

| Address | Name | Description | Access |
|-------------|---------|--------------------------------|------------|
| 0xE002 C000 | PINSEL0 | pin function select register 0 | read/write |
| 0xE002 C004 | PINSEL1 | pin function select register 1 | read/write |
| 0xE002 C014 | PINSEL2 | pin function select register 2 | read/write |

6.6 Pin function select register 0 (PINSEL0 - 0xE002 C000)

The PINSEL0 register controls the functions of the pins as per the settings listed in [Table 7](#). The direction control bit in the IODIR register is effective only when the GPIO function is selected for a pin. For other functions, direction is controlled automatically. Settings other than those shown in [Table 7](#) are reserved, and should not be used

Table 7. Pin function select register 0 (PINSEL0 - 0xE002 C000)

| PINSEL0 | Pin name | Value | Function | Value after reset |
|---------|----------|-------|----------------------------|-------------------|
| 1:0 | P0.0 | 0 0 | GPIO Port 0.0 | 0 |
| | | 0 1 | TXD0 (UART0) | |
| | | 1 0 | PWM1 | |
| | | 1 1 | reserved | |
| 3:2 | P0.1 | 0 0 | GPIO Port 0.1 | 0 |
| | | 0 1 | RXD0 (UART0) | |
| | | 1 0 | PWM3 | |
| | | 1 1 | EINT0 | |
| 5:4 | P0.2 | 0 0 | GPIO Port 0.2 | 0 |
| | | 0 1 | SCL (I ² C-bus) | |
| | | 1 0 | Capture 0.0 (Timer 0) | |
| | | 1 1 | reserved | |
| 7:6 | P0.3 | 0 0 | GPIO Port 0.3 | 0 |
| | | 0 1 | SDA (I ² C-bus) | |
| | | 1 0 | Match 0.0 (Timer 0) | |
| | | 1 1 | EINT1 | |
| 9:8 | P0.4 | 0 0 | GPIO Port 0.4 | 0 |
| | | 0 1 | SCK (SPI0) | |
| | | 1 0 | Capture 0.1 (Timer 0) | |
| | | 1 1 | reserved | |

Table 7. Pin function select register 0 (PINSEL0 - 0xE002 C000) ...continued

| PINSEL0 | Pin name | Value | | Function | Value after reset |
|---------|----------|-------|---|-----------------------|-------------------|
| 11:10 | P0.5 | 0 | 0 | GPIO Port 0.5 | 0 |
| | | 0 | 1 | MISO (SPI0) | |
| | | 1 | 0 | Match 0.1 (Timer 0) | |
| | | 1 | 1 | reserved | |
| 13:12 | P0.6 | 0 | 0 | GPIO Port 0.6 | 0 |
| | | 0 | 1 | MOSI (SPI0) | |
| | | 1 | 0 | Capture 0.2 (Timer 0) | |
| | | 1 | 1 | reserved | |
| 15:14 | P0.7 | 0 | 0 | GPIO Port 0.7 | 0 |
| | | 0 | 1 | SSEL (SPI0) | |
| | | 1 | 0 | PWM2 | |
| | | 1 | 1 | EINT2 | |
| 17:16 | P0.8 | 0 | 0 | GPIO Port 0.8 | 0 |
| | | 0 | 1 | TXD1 UART1 | |
| | | 1 | 0 | PWM4 | |
| | | 1 | 1 | reserved | |
| 19:18 | P0.9 | 0 | 0 | GPIO Port 0.9 | 0 |
| | | 0 | 1 | RXD1 (UART1) | |
| | | 1 | 0 | PWM6 | |
| | | 1 | 1 | EINT3 | |
| 21:20 | P0.10 | 0 | 0 | GPIO Port 0.10 | 0 |
| | | 0 | 1 | RTS1 (UART1) | |
| | | 1 | 0 | Capture 1.0 (Timer 1) | |
| | | 1 | 1 | reserved | |
| 23:22 | P0.11 | 0 | 0 | GPIO Port 0.11 | 0 |
| | | 0 | 1 | CTS1 (UART1) | |
| | | 1 | 0 | Capture 1.1 (Timer 1) | |
| | | 1 | 1 | reserved | |
| 25:24 | P0.12 | 0 | 0 | GPIO Port 0.12 | 0 |
| | | 0 | 1 | DSR1 (UART1) | |
| | | 1 | 0 | Match 1.0 (Timer 1) | |
| | | 1 | 1 | reserved | |
| 27:26 | P0.13 | 0 | 0 | GPIO Port 0.13 | 0 |
| | | 0 | 1 | DTR1 (UART1) | |
| | | 1 | 0 | Match 1.1 (Timer 1) | |
| | | 1 | 1 | reserved | |
| 29:28 | P0.14 | 0 | 0 | GPIO Port 0.14 | 0 |
| | | 0 | 1 | DCD1 (UART1) | |
| | | 1 | 0 | EINT1 | |
| | | 1 | 1 | reserved | |

Table 7. Pin function select register 0 (PINSEL0 - 0xE002 C000) ...continued

| PINSEL0 | Pin name | Value | | Function | Value after reset |
|---------|----------|-------|---|----------------|-------------------|
| 31:30 | P0.15 | 0 | 0 | GPIO Port 0.15 | 0 |
| | | 0 | 1 | RI1 (UART1) | |
| | | 1 | 0 | EINT2 | |
| | | 1 | 1 | reserved | |

6.7 Pin function select register 1 (PINSEL1 - 0xE002 C004)

The PINSEL1 register controls the functions of the pins as per the settings listed in [Table 8](#). The direction control bit in the IODIR register is effective only when the GPIO function is selected for a pin. For other functions direction is controlled automatically. Settings other than those shown in the [Table 8](#) are reserved, and should not be used.

Table 8. Pin function select register 1 (PINSEL1 - 0xE002 C004)

| PINSEL1 | Pin name | Value | | Function | Value after reset |
|---------|----------|-------|---|-----------------------|-------------------|
| 1:0 | P0.16 | 0 | 0 | GPIO Port 0.16 | 0 |
| | | 0 | 1 | EINT0 | |
| | | 1 | 0 | Match 0.2 (Timer 0) | |
| | | 1 | 1 | Capture 0.2 (Timer 0) | |
| 3:2 | P0.17 | 0 | 0 | GPIO Port 0.17 | 0 |
| | | 0 | 1 | Capture 1.2 (Timer 1) | |
| | | 1 | 0 | SCK (SPI1) | |
| | | 1 | 1 | Match 1.2 (Timer 1) | |
| 5:4 | P0.18 | 0 | 0 | GPIO Port 0.18 | 0 |
| | | 0 | 1 | Capture 1.3 (Timer 1) | |
| | | 1 | 0 | MISO (SPI1) | |
| | | 1 | 1 | Match 1.3 (Timer 1) | |
| 7:6 | P0.19 | 0 | 0 | GPIO Port 0.19 | 0 |
| | | 0 | 1 | Match 1.2 (Timer 1) | |
| | | 1 | 0 | MOSI (SPI1) | |
| | | 1 | 1 | Capture 1.2 (Timer 1) | |
| 9:8 | P0.20 | 0 | 0 | GPIO Port 0.20 | 0 |
| | | 0 | 1 | Match 1.3 (Timer 1) | |
| | | 1 | 0 | SSEL (SPI1) | |
| | | 1 | 1 | EINT3 | |
| 11:10 | P0.21 | 0 | 0 | GPIO Port 0.21 | 0 |
| | | 0 | 1 | PWM5 | |
| | | 1 | 0 | reserved | |
| | | 1 | 1 | Capture 1.3 (Timer 1) | |
| 13:12 | P0.22 | 0 | 0 | GPIO Port 0.22 | 0 |
| | | 0 | 1 | reserved | |
| | | 1 | 0 | Capture 0.0 (Timer 0) | |
| | | 1 | 1 | Match 0.0 (Timer 0) | |

Table 8. Pin function select register 1 (PINSEL1 - 0xE002 C004) ...continued

| PINSEL1 | Pin name | Value | | Function | Value after reset |
|---------|----------|-------|---|-----------------------|-------------------|
| 15:14 | P0.23 | 0 | 0 | GPIO Port 0.23 | 0 |
| | | 0 | 1 | reserved | |
| | | 1 | 0 | reserved | |
| | | 1 | 1 | reserved | |
| 17:16 | P0.24 | 0 | 0 | GPIO Port 0.24 | 0 |
| | | 0 | 1 | reserved | |
| | | 1 | 0 | reserved | |
| | | 1 | 1 | reserved | |
| 19:18 | P0.25 | 0 | 0 | GPIO Port 0.25 | 0 |
| | | 0 | 1 | reserved | |
| | | 1 | 0 | reserved | |
| | | 1 | 1 | reserved | |
| 21:20 | P0.26 | 0 | 0 | reserved | 0 |
| | | 0 | 1 | reserved | |
| | | 1 | 0 | reserved | |
| | | 1 | 1 | reserved | |
| 23:22 | P0.27 | 0 | 0 | GPIO Port 0.27 | 1 |
| | | 0 | 1 | AIN0 (A/D input 0) | |
| | | 1 | 0 | Capture 0.1 (Timer 0) | |
| | | 1 | 1 | Match 0.1 (Timer 0) | |
| 25:24 | P0.28 | 0 | 0 | GPIO Port 0.28 | 1 |
| | | 0 | 1 | AIN1 (A/D input 1) | |
| | | 1 | 0 | Capture 0.2 (Timer 0) | |
| | | 1 | 1 | Match 0.2 (Timer 0) | |
| 27:26 | P0.29 | 0 | 0 | GPIO Port 0.29 | 1 |
| | | 0 | 1 | AIN2 (A/D input 2) | |
| | | 1 | 0 | Capture 0.3 (Timer 0) | |
| | | 1 | 1 | Match 0.3 (Timer 0) | |
| 29:28 | P0.30 | 0 | 0 | GPIO Port 0.30 | 1 |
| | | 0 | 1 | AIN3 (A/D input 0) | |
| | | 1 | 0 | EINT3 | |
| | | 1 | 1 | Capture 0.0 (Timer 0) | |
| 31:30 | P0.31 | 0 | 0 | reserved | 0 |
| | | 0 | 1 | reserved | |
| | | 1 | 0 | reserved | |
| | | 1 | 1 | reserved | |

6.8 Pin function select register 2 (PINSEL2 - 0xE002 C014)

The PINSEL2 register controls the functions of the pins as per the settings listed in [Table 9](#). The direction control bit in the IODIR register is effective only when the GPIO function is selected for a pin. For other functions direction is controlled automatically. Settings other than those shown in [Table 9](#) are reserved, and should not be used.

Table 9. Pin function select register 2 (PINSEL2 - 0xE002 C014)

| PINSEL2 bits | Description | Reset value |
|--------------|--|---------------------|
| 1:0 | reserved | - |
| 2 | When 0, pins P1[36:26] are used as GPIO pins. When 1, P1[31:26] are used as a Debug port. | P1.26/RTCK |
| 3 | When 0, pins P1[25:16] are used as GPIO pins. When 1, P1[25:16] are used as a Trace port. | P1.20/ TRACESYNC |
| 5:4 | Controls the use of the data bus and strobe pins: | BOOT1:0 |
| | Pins P2[7:0] 11 = P2[7:0] 0x or 10 = D7 to D0 | |
| | Pin P1.0 11 = P1.0 0x or 10 = $\overline{CS0}$ | |
| | Pin P1.1 11 = P1.1 0x or 10 = \overline{OE} | |
| | Pin P3.31 11 = P3.31 0x or 10 = $\overline{BLS0}$ | |
| | Pins P2[15:8] 00 or 11 = P2[15:8] 01 or 10 = D15 to D8 | |
| | Pin P3.30 00 or 11 = P3.30 01 or 10 = $\overline{BLS1}$ | |
| | Pins P2[27:16] 0x or 11 = P2[27:16] 10 = D27 to D16 | |
| | Pins P2[29:28] 0x or 11 = P2[29:28] 10 = D29, D28 | |
| | Pins P2[31:30] 0x or 11 = P2[31:30] or AIN5 to AIN4 10 = D31, D30 | |
| | Pins P3[29:28] 0x or 11 = P3[29:28] or AIN7 to AIN6 10 = $\overline{BLS2}$, $\overline{BLS3}$ | |
| 6 | If bits 5:4 are not 10, controls the use of pin P3.29: 0 enables P3.29, 1 enables AIN6. | 1 |
| 7 | If bits 5:4 are not 10, controls the use of pin P3.28: 0 enables P3.28, 1 enables AIN7. | 1 |
| 8 | Controls the use of pin P3.27: 0 enables P3.27, 1 enables \overline{WE} . | 0 |
| 10:9 | reserved | - |
| 11 | Controls the use of pin P3.26: 0 enables P3.26, 1 enables $\overline{CS1}$. | 0 |
| 12 | reserved | - |
| 13 | If bits 27:25 are not 111, controls the use of pin P3.23/A23/XCLK: 0 enables P3.23, 1 enables XCLK. | 0 |
| 15:14 | Controls the use of pin P3.25: 00 enables P3.25, 01 enables $\overline{CS2}$, 10 and 11 are reserved values. | 00 |
| 17:16 | Controls the use of pin P3.24: 00 enables P3.24, 01 enables $\overline{CS3}$, 10 and 11 are reserved values. | 00 |
| 19:18 | reserved | - |
| 20 | If bits 5:4 are not 10, controls the use of pin P2[29:28]: 0 enables P2[29:28], 1 is reserved | 0 |
| 21 | If bits 5:4 are not 10, controls the use of pin P2.30: 0 enables P2.30, 1 enables AIN4. | 1 |
| 22 | If bits 5:4 are not 10, controls the use of pin P2.31: 0 enables P2.31, 1 enables AIN5. | 1 |

Table 9. Pin function select register 2 (PINSEL2 - 0xE002 C014) ...continued

| PINSEL2 bits | Description | Reset value |
|--------------|---|---|
| 23 | Controls whether P3.0/A0 is a port pin (0) or an address line (1). | 1 if BOOT1:0 = 00 at $\overline{\text{RESET}}$ = 0, 0 otherwise |
| 24 | Controls whether P3.1/A1 is a port pin (0) or an address line (1). | $\overline{\text{BOOT1}}$ during reset |
| 27:25 | Controls the number of pins among P3.23/A23/XCLK and P3[22:2]/A2[22:2] that are address lines: 000 = None 001 = A3 to A2 are address lines. 010 = A5 to A2 are address lines. 011 = A7 to A2 are address lines. | 000 if BOOT1:0 = 11 at reset, 111 otherwise |
| | 100 = A11 to A2 are address lines. | |
| | 101 = A15 to A2 are address lines. | |
| | 110 = A19 to A2 are address lines. | |
| | 111 = A23 to A2 are address lines. | |
| 31:28 | reserved | |

6.9 External memory controller

The external static memory controller is a module which provides an interface between the system bus and external (off-chip) memory devices. It provides support for up to four independently configurable memory banks (16 MB each with byte lane enable control) simultaneously. Each memory bank is capable of supporting SRAM, ROM, flash EPROM, burst ROM memory, or some external I/O devices.

Each memory bank may be 8-bit, 16-bit, or 32-bit wide.

6.10 General purpose parallel I/O

Device pins that are not connected to a specific peripheral function are controlled by the GPIO registers. Pins may be dynamically configured as inputs or outputs. Separate registers allow setting or clearing any number of outputs simultaneously. The value of the output register may be read back, as well as the current state of the port pins.

6.10.1 Features

- Direction control of individual bits.
- Separate control of output set and clear.
- All I/O default to inputs after reset.

6.11 10-bit ADC

The LPC2210/2220 each contain a single 10-bit successive approximation ADC with eight multiplexed channels.

6.11.1 Features

- Measurement range of 0 V to 3 V.
- Capable of performing more than 400000 10-bit samples per second.
- Burst conversion mode for single or multiple inputs.

- Optional conversion on transition on input pin or Timer Match signal.

6.11.2 ADC features available in LPC2210/01 and LPC2220 only

- Every analog input has a dedicated result register to reduce interrupt overhead.
- Every analog input can generate an interrupt once the conversion is completed.
- The ADC pads are 5 V tolerant when configured for digital I/O function(s).

6.12 UARTs

The LPC2210/2220 each contain two UARTs. One UART provides a full modem control handshake interface, the other provides only transmit and receive data lines.

6.12.1 Features

- 16 B receive and transmit FIFOs.
- Register locations conform to 16C550 industry standard.
- Receiver FIFO trigger points at 1 B, 4 B, 8 B, and 14 B.
- Built-in baud rate generator.
- Standard modem interface signals included on UART1.

6.12.2 UART features available in LPC2210/01 and LPC2220 only

Compared to previous LPC2000 microcontrollers, UARTs in LPC2210/01 and LPC2220 introduce a fractional baud rate generator for both UARTs, enabling these microcontrollers to achieve standard baud rates such as 115200 Bd with any crystal frequency above 2 MHz. In addition, auto-CTS/RTS flow-control functions are fully implemented in hardware.

- Fractional baud rate generator enables standard baud rates such as 115200 Bd to be achieved with any crystal frequency above 2 MHz.
- Auto-bauding.
- Auto-CTS/RTS flow-control fully implemented in hardware.

6.13 I²C-bus serial I/O controller

The I²C-bus is bidirectional for inter-IC control using only two wires: a serial clock line (SCL), and a serial data line (SDA). Each device is recognized by a unique address and can operate as either a receiver-only device (e.g., an LCD driver or a transmitter with the capability to both receive and send information (such as memory). Transmitters and/or receivers can operate in either master or slave mode, depending on whether the chip has to initiate a data transfer or is only addressed. The I²C-bus is a multi-master bus, and it can be controlled by more than one bus master connected to it.

The I²C-bus implemented in LPC2210/2220 supports a bit rate up to 400 kbit/s (fast I²C-bus).

6.13.1 Features

- Compliant with standard I²C-bus interface.
- Easy to configure as master, slave, or master/slave.

- Programmable clocks allow versatile rate control.
- Bidirectional data transfer between masters and slaves.
- Multi-master bus (no central master).
- Arbitration between simultaneously transmitting masters without corruption of serial data on the bus.
- Serial clock synchronization allows devices with different bit rates to communicate via one serial bus.
- Serial clock synchronization can be used as a handshake mechanism to suspend and resume serial transfer.
- The I²C-bus may be used for test and diagnostic purposes.

6.14 SPI serial I/O controller

The LPC2210/2220 each contain two SPIs. The SPI is a full duplex serial interface, designed to be able to handle multiple masters and slaves connected to a given bus. Only a single master and a single slave can communicate on the interface during a given data transfer. During a data transfer the master always sends a byte of data to the slave, and the slave always sends a byte of data to the master.

6.14.1 Features

- Compliant with SPI specification.
- Synchronous, serial, full duplex, communication.
- Combined SPI master and slave.
- Maximum data bit rate of one eighth of the input clock rate.

6.15 SSP controller

This peripheral is available in LPC2210/01 and LPC2220 only.

6.15.1 Features

- Compatible with Motorola's SPI, Texas Instrument's 4-wire SSI, and National Semiconductor's Microwire buses.
- Synchronous serial communication.
- Master or slave operation.
- 8-frame FIFOs for both transmit and receive.
- 4 bits to 16 bits per frame.

6.15.2 Description

The SSP is a controller capable of operation on a SPI, 4-wire SSI, or Microwire bus. It can interact with multiple masters and slaves on the bus. Only a single master and a single slave can communicate on the bus during a given data transfer. Data transfers are in principle full duplex, with frames of 4 bits to 16 bits of data flowing from the master to the slave and from the slave to the master.

While the SSP and SPI1 peripherals share the same physical pins, it is not possible to have both of these two peripherals active at the same time. Application can switch on the fly from SPI1 to SSP and back.

6.16 General purpose timers

The timer/counter is designed to count cycles of the peripheral clock (PCLK) or an externally supplied clock and optionally generate interrupts or perform other actions at specified timer values, based on four match registers. It also includes four capture inputs to trap the timer value when an input signal transitions, optionally generating an interrupt. Multiple pins can be selected to perform a single capture or match function, providing an application with 'or' and 'and', as well as 'broadcast' functions among them.

6.16.1 Features

- A 32-bit timer/counter with a programmable 32-bit prescaler.
- Timer operation (LPC2210/2220) or external event counter (LPC2210/01 and LPC2220 only).
- Four 32-bit capture channels per timer/counter that can take a snapshot of the timer value when an input signal transitions. A capture event may also optionally generate an interrupt.
- Four 32-bit match registers that allow:
 - Continuous operation with optional interrupt generation on match.
 - Stop timer on match with optional interrupt generation.
 - Reset timer on match with optional interrupt generation.
- Four external outputs per timer/counter corresponding to match registers, with the following capabilities:
 - Set LOW on match.
 - Set HIGH on match.
 - Toggle on match.
 - Do nothing on match.

6.16.2 Features available in LPC2210/01 and LPC2220 only

The LPC2210/01 and LPC2220 can count external events on one of the capture inputs if the external pulse lasts at least one half of the period of the PCLK. In this configuration, unused capture lines can be selected as regular timer capture inputs or used as external interrupts.

- Timer can count cycles of either the peripheral clock (PCLK) or an externally supplied clock.
- When counting cycles of an externally supplied clock, only one of the timer's capture inputs can be selected as the timer's clock. The rate of such a clock is limited to $PCLK / 4$. Duration of high/low levels on the selected capture input cannot be shorter than $1 / (2PCLK)$.

6.17 Watchdog timer

The purpose of the watchdog is to reset the microcontroller within a reasonable amount of time if it enters an erroneous state. When enabled, the watchdog will generate a system reset if the user program fails to 'feed' (or reload) the watchdog within a predetermined amount of time.

6.17.1 Features

- Internally resets chip if not periodically reloaded.
- Debug mode.
- Enabled by software but requires a hardware reset or a watchdog reset/interrupt to be disabled.
- Incorrect/incomplete feed sequence causes reset/interrupt if enabled.
- Flag to indicate watchdog reset.
- Programmable 32-bit timer with internal prescaler.
- Selectable time period from $(T_{cy(PCLK)} \times 256 \times 4)$ to $(T_{cy(PCLK)} \times 2^{32} \times 4)$ in multiples of $T_{cy(PCLK)} \times 4$.

6.18 Real-time clock

The Real-Time Clock (RTC) is designed to provide a set of counters to measure time when normal or idle operating mode is selected. The RTC has been designed to use little power, making it suitable for battery powered systems where the CPU is not running continuously (Idle mode).

6.18.1 Features

- Measures the passage of time to maintain a calendar and clock.
- Ultra-low power design to support battery powered systems.
- Provides Seconds, Minutes, Hours, Day of Month, Month, Year, Day of Week, and Day of Year.
- Programmable reference clock divider allows adjustment of the RTC to match various crystal frequencies.

6.19 Pulse width modulator

The PWM is based on the standard timer block and inherits all of its features, although only the PWM function is pinned out on the LPC2210/2220. The timer is designed to count cycles of the peripheral clock (PCLK) and optionally generate interrupts or perform other actions when specified timer values occur, based on seven match registers. The PWM function is also based on match register events.

The ability to separately control rising and falling edge locations allows the PWM to be used for more applications. For instance, multi-phase motor control typically requires three non-overlapping PWM outputs with individual control of all three pulse widths and positions.

Two match registers can be used to provide a single edge controlled PWM output. One match register (MR0) controls the PWM cycle rate, by resetting the count upon match. The other match register controls the PWM edge position. Additional single edge

controlled PWM outputs require only one match register each, since the repetition rate is the same for all PWM outputs. Multiple single edge controlled PWM outputs will all have a rising edge at the beginning of each PWM cycle, when an MR0 match occurs.

Three match registers can be used to provide a PWM output with both edges controlled. Again, the MR0 match register controls the PWM cycle rate. The other match registers control the two PWM edge positions. Additional double edge controlled PWM outputs require only two match registers each, since the repetition rate is the same for all PWM outputs.

With double edge controlled PWM outputs, specific match registers control the rising and falling edge of the output. This allows both positive going PWM pulses (when the rising edge occurs prior to the falling edge), and negative going PWM pulses (when the falling edge occurs prior to the rising edge).

6.19.1 Features

- Seven match registers allow up to six single edge controlled or three double edge controlled PWM outputs, or a mix of both types.
- The match registers also allow:
 - Continuous operation with optional interrupt generation on match.
 - Stop timer on match with optional interrupt generation.
 - Reset timer on match with optional interrupt generation.
- Supports single edge controlled and/or double edge controlled PWM outputs. Single edge controlled PWM outputs all go HIGH at the beginning of each cycle unless the output is a constant LOW. Double edge controlled PWM outputs can have either edge occur at any position within a cycle. This allows for both positive going and negative going pulses.
- Pulse period and width can be any number of timer counts. This allows complete flexibility in the trade-off between resolution and repetition rate. All PWM outputs will occur at the same repetition rate.
- Double edge controlled PWM outputs can be programmed to be either positive going or negative going pulses.
- Match register updates are synchronized with pulse outputs to prevent generation of erroneous pulses. Software must 'release' new match values before they can become effective.
- May be used as a standard timer if the PWM mode is not enabled.
- A 32-bit timer/counter with a programmable 32-bit prescaler.

6.20 System control

6.20.1 Crystal oscillator

The oscillator supports crystals in the range of 1 MHz to 25 MHz and up to 25 MHz with the external oscillator. The oscillator output frequency is called f_{osc} and the ARM processor clock frequency is referred to as CCLK for purposes of rate equations, etc. f_{osc} and CCLK are the same value unless the PLL is running and connected. Refer to [Section 6.20.2 "PLL"](#) for additional information.

6.20.2 PLL

The PLL accepts an input clock frequency in the range of 10 MHz to 25 MHz. The input frequency is multiplied up into the range of 10 MHz to 60 MHz (LPC2210) and 10 MHz to 75 MHz (LPC2210/01 and LPC2220) with a Current Controlled Oscillator (CCO). The multiplier can be an integer value from 1 to 32 (in practice, the multiplier value cannot be higher than 6 on this family of microcontrollers due to the upper frequency limit of the CPU). The CCO operates in the range of 156 MHz to 320 MHz, so there is an additional divider in the loop to keep the CCO within its frequency range while the PLL is providing the desired output frequency. The output divider may be set to divide by 2, 4, 8, or 16 to produce the output clock. Since the minimum output divider value is 2, it is insured that the PLL output has a 50 % duty cycle. The PLL is turned off and bypassed following a chip reset and may be enabled by software. The program must configure and activate the PLL, wait for the PLL to Lock, then connect to the PLL as a clock source. The PLL settling time is 100 μ s.

6.20.3 Reset and wake-up timer

Reset has two sources on the LPC2210/2220: the $\overline{\text{RESET}}$ pin and watchdog reset. The $\overline{\text{RESET}}$ pin is a Schmitt trigger input pin with an additional glitch filter. Assertion of chip reset by any source starts the wake-up timer (see wake-up timer description below), causing the internal chip reset to remain asserted until the external reset is de-asserted, the oscillator is running, a fixed number of clocks have passed, and the on-chip circuitry has completed its initialization.

When the internal reset is removed, the processor begins executing at address 0, which is the reset vector. At that point, all of the processor and peripheral registers have been initialized to predetermined values.

The wake-up timer ensures that the oscillator and other analog functions required for chip operation are fully functional before the processor is allowed to execute instructions. This is important at power-on, all types of reset, and whenever any of the aforementioned functions are turned off for any reason. Since the oscillator and other functions are turned off during Power-down mode, any wake-up of the processor from Power-down mode makes use of the wake-up timer.

The wake-up timer monitors the crystal oscillator as the means of checking whether it is safe to begin code execution. When power is applied to the chip, or some event caused the chip to exit Power-down mode, some time is required for the oscillator to produce a signal of sufficient amplitude to drive the clock logic. The amount of time depends on many factors, including the rate of V_{DD} ramp (in the case of power on), the type of crystal and its electrical characteristics (if a quartz crystal is used), as well as any other external circuitry (e.g. capacitors), and the characteristics of the oscillator itself under the existing ambient conditions.

6.20.4 External interrupt inputs

The LPC2210/2220 include up to nine edge or level sensitive external interrupt inputs as selectable pin functions. When the pins are combined, external events can be processed as four independent interrupt signals. The external interrupt inputs can optionally be used to wake up the processor from Power-down mode.

6.20.5 Memory mapping control

The memory mapping control alters the mapping of the interrupt vectors that appear beginning at address 0x0000 0000. Vectors may be mapped to the bottom of the BANK0 external memory, or to the on-chip static RAM. This allows code running in different memory spaces to have control of the interrupts.

6.20.6 Power control

The LPC2210/2220 support two reduced power modes: Idle mode and Power-down mode.

In Idle mode, execution of instructions is suspended until either a reset or interrupt occurs. Peripheral functions continue operation during Idle mode and may generate interrupts to cause the processor to resume execution. Idle mode eliminates power used by the processor itself, memory systems and related controllers, and internal buses.

In Power-down mode, the oscillator is shut down, and the chip receives no internal clocks. The processor state and registers, peripheral registers, and internal SRAM values are preserved throughout Power-down mode, and the logic levels of chip output pins remain static. The Power-down mode can be terminated and normal operation resumed by either a reset or certain specific interrupts that are able to function without clocks. Since all dynamic operation of the chip is suspended, Power-down mode reduces chip power consumption to nearly zero.

A power control for peripherals feature allows individual peripherals to be turned off if they are not needed in the application, resulting in additional power savings.

6.20.7 APB

The APB divider determines the relationship between the processor clock (CCLK) and the clock used by peripheral devices (PCLK). The APB divider serves two purposes. The first is to provide peripherals with the desired PCLK via APB so that they can operate at the speed chosen for the ARM processor. In order to achieve this, the APB may be slowed down to $\frac{1}{2}$ to $\frac{1}{4}$ of the processor clock rate. Because the APB must work properly at power-up (and its timing cannot be altered if it does not work since the APB divider control registers reside on the APB), the default condition at reset is for the APB to run at $\frac{1}{4}$ of the processor clock rate. The second purpose of the APB divider is to allow power savings when an application does not require any peripherals to run at the full processor rate. Because the APB divider is connected to the PLL output, the PLL remains active (if it was running) during Idle mode.

6.21 Emulation and debugging

The LPC2210/2220 support emulation and debugging via a JTAG serial port. A trace port allows tracing program execution. Debugging and trace functions are multiplexed only with GPIOs on Port 1. This means that all communication, timer and interface peripherals residing on Port 0 are available during the development and debugging phase as they are when the application is run in the embedded system itself.

6.21.1 EmbeddedICE

Standard ARM EmbeddedICE logic provides on-chip debug support. The debugging of the target system requires a host computer running the debugger software and an EmbeddedICE protocol converter. EmbeddedICE protocol converter converts the remote debug protocol commands to the JTAG data needed to access the ARM core.

The ARM core has a Debug Communication Channel (DCC) function built-in. The debug communication channel allows a program running on the target to communicate with the host debugger or another separate host without stopping the program flow or even entering the debug state. The debug communication channel is accessed as a co-processor 14 by the program running on the ARM7TDMI-S core. The debug communication channel allows the JTAG port to be used for sending and receiving data without affecting the normal program flow. The debug communication channel data and control registers are mapped in to addresses in the EmbeddedICE logic.

The JTAG clock (TCK) must be slower than $\frac{1}{6}$ of the CPU clock (CCLK) for the JTAG interface to operate.

6.21.2 Embedded trace

Since the LPC2210/2220 have significant amounts of on-chip memory, it is not possible to determine how the processor core is operating simply by observing the external pins. The Embedded Trace Macrocell (ETM) provides real-time trace capability for deeply embedded processor cores. It outputs information about processor execution to the trace port.

The ETM is connected directly to the ARM core and not to the main AMBA system bus. It compresses the trace information and exports it through a narrow trace port. An external trace port analyzer must capture the trace information under software debugger control. Instruction trace (or PC trace) shows the flow of execution of the processor and provides a list of all the instructions that were executed. Instruction trace is significantly compressed by only broadcasting branch addresses as well as a set of status signals that indicate the pipeline status on a cycle by cycle basis. Trace information generation can be controlled by selecting the trigger resource. Trigger resources include address comparators, counters and sequencers. Since trace information is compressed the software debugger requires a static image of the code being executed. Self-modifying code cannot be traced because of this restriction.

6.21.3 RealMonitor

RealMonitor is a configurable software module, developed by ARM Inc., which enables real-time debug. It is a lightweight debug monitor that runs in the background while users debug their foreground application. It communicates with the host using the debug communication channel, which is present in the EmbeddedICE logic. The LPC2210/2220 contain a specific configuration of RealMonitor software programmed into the on-chip flash memory.

7. Limiting values

Table 10. Limiting values reset

In accordance with the Absolute Maximum Rating System (IEC 60134).^[1]

| Symbol | Parameter | Conditions | Min | Max | Unit |
|-----------------|---------------------------------------|--|-------------|---------------------|------|
| $V_{DD(1V8)}$ | supply voltage (1.8 V) | | [2] -0.5 | +2.5 | V |
| $V_{DD(3V3)}$ | supply voltage (3.3 V) | | [3] -0.5 | +3.6 | V |
| $V_{DDA(3V3)}$ | analog supply voltage (3.3 V) | | -0.5 | +4.6 | V |
| V_{IA} | analog input voltage | | -0.5 | +5.1 | V |
| V_I | input voltage | 5 V tolerant I/O pins | [4][5] -0.5 | +6.0 | V |
| | | other I/O pins | [4][6] -0.5 | $V_{DD(3V3)} + 0.5$ | V |
| I_{DD} | supply current | | [7][8] - | 100 | mA |
| I_{SS} | ground current | | [8][9] - | 100 | mA |
| T_{stg} | storage temperature | | [10] -65 | +150 | °C |
| $P_{tot(pack)}$ | total power dissipation (per package) | based on package heat transfer, not device power consumption | - | 1.5 | W |
| V_{esd} | electrostatic discharge voltage | human body model | [11] | | |
| | | all pins | -2000 | +2000 | V |

[1] The following applies to [Table 10](#):

- a) This product includes circuitry specifically designed for the protection of its internal devices from the damaging effects of excessive static charge. Nonetheless, it is suggested that conventional precautions be taken to avoid applying greater than the rated maximum.
- b) Parameters are valid over operating temperature range unless otherwise specified. All voltages are with respect to V_{SS} unless otherwise noted.

[2] Internal rail.

[3] External rail.

[4] Including voltage on outputs in 3-state mode.

[5] Only valid when the $V_{DD(3V3)}$ supply voltage is present.

[6] Not to exceed 4.6 V.

[7] Per supply pin.

[8] The peak current is limited to 25 times the corresponding maximum current.

[9] Per ground pin.

[10] Dependent on package type.

[11] Human body model: equivalent to discharging a 100 pF capacitor through a 1.5 kΩ series resistor.

8. Static characteristics

Table 11. Static characteristics

$T_{amb} = -40\text{ °C}$ to $+85\text{ °C}$ for commercial applications, unless otherwise specified.

| Symbol | Parameter | Conditions | Min | Typ ^[1] | Max | Unit | |
|---|---|---|--|--------------------|---------------|---------------|----|
| $V_{DD(1V8)}$ | supply voltage (1.8 V) | | ^[2] 1.65 | 1.8 | 1.95 | V | |
| $V_{DD(3V3)}$ | supply voltage (3.3 V) | | ^[3] 3.0 | 3.3 | 3.6 | V | |
| $V_{DDA(3V3)}$ | analog supply voltage (3.3 V) | | 2.5 | 3.3 | 3.6 | V | |
| Standard port pins, $\overline{\text{RESET}}$, RTCK | | | | | | | |
| I_{IL} | LOW-level input current | $V_I = 0\text{ V}$; no pull-up | - | - | 3 | μA | |
| I_{IH} | HIGH-level input current | $V_I = V_{DD(3V3)}$; no pull-down | - | - | 3 | μA | |
| I_{OZ} | OFF-state output current | $V_O = 0\text{ V}$, $V_O = V_{DD(3V3)}$; no pull-up/down | - | - | 3 | μA | |
| I_{latch} | I/O latch-up current | $-(0.5V_{DD(3V3)}) < V_I < (1.5V_{DD(3V3)})$; $T_j < 125\text{ °C}$ | 100 | - | - | mA | |
| V_I | input voltage | | ^{[4][5][6]} 0 | - | 5.5 | V | |
| V_O | output voltage | output active | 0 | - | $V_{DD(3V3)}$ | V | |
| V_{IH} | HIGH-level input voltage | | 2.0 | - | - | V | |
| V_{IL} | LOW-level input voltage | | - | - | 0.8 | V | |
| V_{hys} | hysteresis voltage | | 0.4 | - | - | V | |
| V_{OH} | HIGH-level output voltage | $I_{OH} = -4\text{ mA}$ | ^[7] $V_{DD(3V3)} - 0.4$ | - | - | V | |
| V_{OL} | LOW-level output voltage | $I_{OL} = -4\text{ mA}$ | ^[7] - | - | 0.4 | V | |
| I_{OH} | HIGH-level output current | $V_{OH} = V_{DD(3V3)} - 0.4\text{ V}$ | ^[7] -4 | - | - | mA | |
| I_{OL} | LOW-level output current | $V_{OL} = 0.4\text{ V}$ | ^[7] 4 | - | - | mA | |
| I_{OHS} | HIGH-level short circuit output current | $V_{OH} = 0\text{ V}$ | ^[8] - | - | -45 | mA | |
| I_{OLS} | LOW-level short circuit output current | $V_{OL} = V_{DD(3V3)}$ | ^[8] - | - | 50 | mA | |
| I_{pd} | pull-down current | $V_I = 5\text{ V}$ | ^[9] 10 | 50 | 150 | μA | |
| I_{pu} | pull-up current | $V_I = 0\text{ V}$ | ^[10] -15 | -50 | -85 | μA | |
| | | $V_{DD(3V3)} < V_I < 5\text{ V}$ | ^[9] 0 | 0 | 0 | μA | |
| $I_{DD(act)}$ | active mode supply current | $V_{DD(1V8)} = 1.8\text{ V}$; $T_{amb} = 25\text{ °C}$; code while(1){} executed from on-chip RAM; no active peripherals | | | | | |
| | | | CCLK = 60 MHz (LPC2210) | - | 50 | 70 | mA |
| | | | CCLK = 75 MHz (LPC2210/01; LPC2220) | - | 50 | 70 | mA |

Table 11. Static characteristics ...continued

$T_{amb} = -40\text{ }^{\circ}\text{C}$ to $+85\text{ }^{\circ}\text{C}$ for commercial applications, unless otherwise specified.

| Symbol | Parameter | Conditions | Min | Typ ^[1] | Max | Unit |
|--------------------------------|--------------------------------|---|-------------------|--------------------|------------------|---------------|
| $I_{DD(pd)}$ | Power-down mode supply current | $V_{DD(1V8)} = 1.8\text{ V};$ $T_{amb} = 25\text{ }^{\circ}\text{C}$ | - | 10 | - | μA |
| | | $V_{DD(1V8)} = 1.8\text{ V};$ $T_{amb} = 85\text{ }^{\circ}\text{C}$ | - | 110 | 500 | μA |
| I²C-bus pins | | | | | | |
| V_{IH} | HIGH-level input voltage | | $0.7V_{DD(3V3)}$ | - | - | V |
| V_{IL} | LOW-level input voltage | | - | - | $0.3V_{DD(3V3)}$ | V |
| V_{hys} | hysteresis voltage | | - | $0.5V_{DD(3V3)}$ | - | V |
| V_{OL} | LOW-level output voltage | $I_{OLS} = 3\text{ mA}$ | ^[7] - | - | 0.4 | V |
| I_{LI} | input leakage current | $V_I = V_{DD(3V3)}$ | ^[11] - | 2 | 4 | μA |
| | | $V_I = 5\text{ V}$ | - | 10 | 22 | μA |
| Oscillator pins | | | | | | |
| $V_{i(XTAL1)}$ | input voltage on pin XTAL1 | | 0 | - | 1.8 | V |
| $V_{o(XTAL2)}$ | output voltage on pin XTAL2 | | 0 | - | 1.8 | V |

- [1] Typical ratings are not guaranteed. The values listed are at room temperature (+25 °C), nominal supply voltages.
- [2] Internal rail.
- [3] External rail.
- [4] Including voltage on outputs in 3-state mode.
- [5] $V_{DD(3V3)}$ supply voltages must be present.
- [6] 3-state outputs go into 3-state mode when $V_{DD(3V3)}$ is grounded.
- [7] Accounts for 100 mV voltage drop in all supply lines.
- [8] Allowed as long as the current limit does not exceed the maximum current allowed by the device.
- [9] Minimum condition for $V_I = 4.5\text{ V}$, maximum condition for $V_I = 5.5\text{ V}$.
- [10] Applies to P1[25:16].
- [11] To V_{SS} .

Table 12. ADC static characteristics

$V_{DDA(3V3)} = 2.5\text{ V to }3.6\text{ V}$; $T_{amb} = -40\text{ }^{\circ}\text{C to }+85\text{ }^{\circ}\text{C}$ unless otherwise specified. ADC frequency 4.5 MHz.

| Symbol | Parameter | Conditions | Min | Typ | Max | Unit |
|--------------|------------------------------|------------|-----------|-----|----------------|------|
| V_{IA} | analog input voltage | | 0 | - | $V_{DDA(3V3)}$ | V |
| C_{ia} | analog input capacitance | | - | - | 1 | pF |
| E_D | differential linearity error | | [1][2][3] | - | ± 1 | LSB |
| $E_{L(adj)}$ | integral non-linearity | | [1][4] | - | ± 2 | LSB |
| E_O | offset error | | [1][5] | - | ± 3 | LSB |
| E_G | gain error | | [1][6] | - | ± 0.5 | % |
| E_T | absolute error | | [1][7] | - | ± 4 | LSB |

[1] Conditions: $V_{SSA} = 0\text{ V}$, $V_{DDA(3V3)} = 3.3\text{ V}$.

[2] The ADC is monotonic, there are no missing codes.

[3] The differential linearity error (E_D) is the difference between the actual step width and the ideal step width. See [Figure 5](#).

[4] The integral non-linearity ($E_{L(adj)}$) is the peak difference between the center of the steps of the actual and the ideal transfer curve after appropriate adjustment of gain and offset errors. See [Figure 5](#).

[5] The offset error (E_O) is the absolute difference between the straight line which fits the actual curve and the straight line which fits the ideal curve. See [Figure 5](#).

[6] The gain error (E_G) is the relative difference in percent between the straight line fitting the actual transfer curve after removing offset error, and the straight line which fits the ideal transfer curve. See [Figure 5](#).

[7] The absolute voltage error (E_T) is the maximum difference between the center of the steps of the actual transfer curve of the non-calibrated ADC and the ideal transfer curve. See [Figure 5](#).

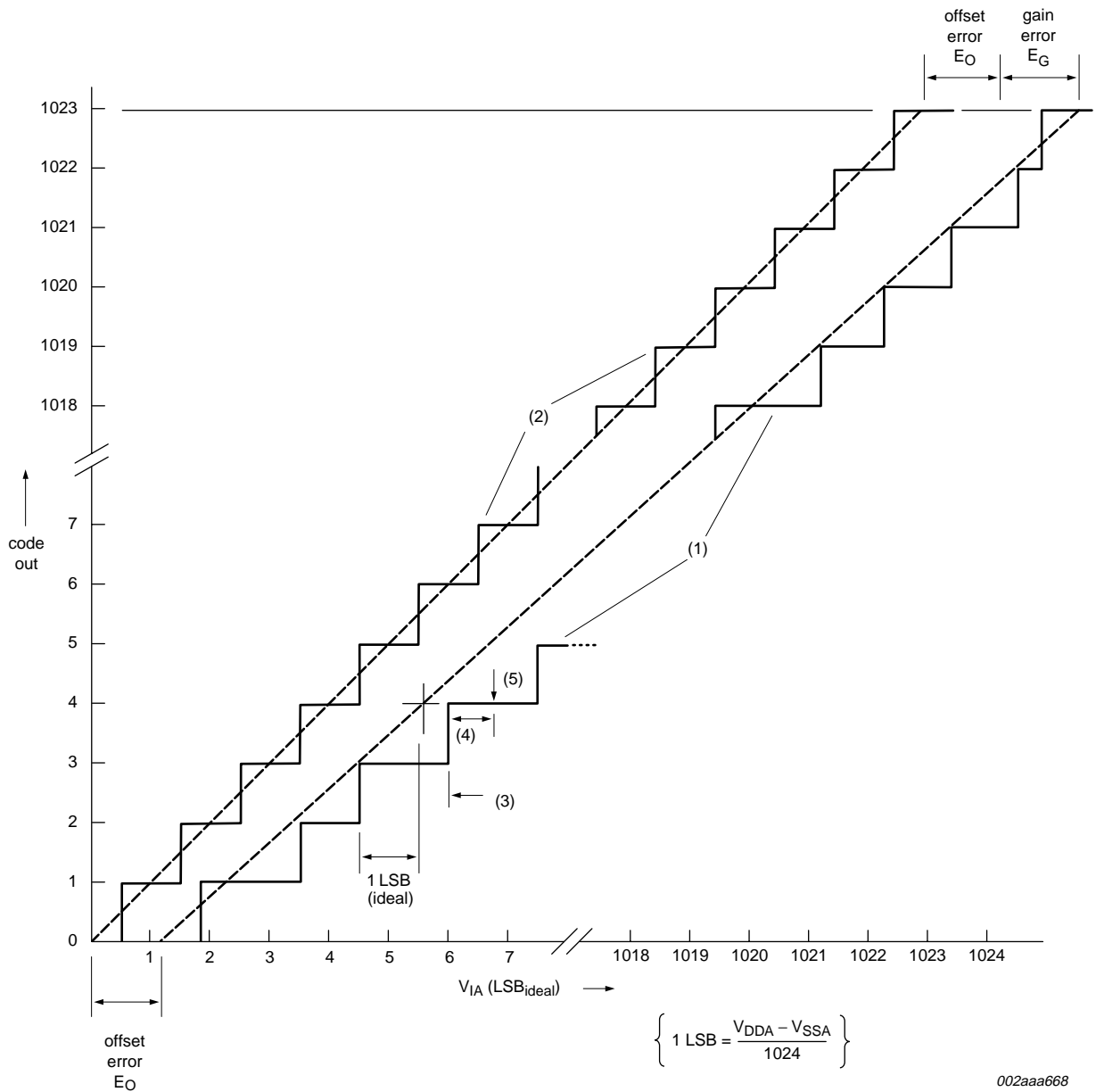

- (1) Example of an actual transfer curve.
- (2) The ideal transfer curve.
- (3) Differential linearity error (E_D).
- (4) Integral non-linearity (E_{L(adj)}).
- (5) Center of a step of the actual transfer curve.

Fig 5. ADC characteristics

9. Dynamic characteristics

Table 13. Dynamic characteristics

$T_{amb} = 0\text{ }^{\circ}\text{C}$ to $+70\text{ }^{\circ}\text{C}$ for commercial applications, $-40\text{ }^{\circ}\text{C}$ to $+85\text{ }^{\circ}\text{C}$ for industrial applications, $V_{DD(1V8)}$, $V_{DD(3V3)}$ over specified ranges.^[1]

| Symbol | Parameter | Conditions | Min | Typ | Max | Unit |
|--|----------------------|--|--------------------------------------|-----|------|------|
| External clock | | | | | | |
| f_{osc} | oscillator frequency | supplied by an external oscillator (signal generator) | 1 | - | 25 | MHz |
| | | external clock frequency supplied by an external crystal oscillator | 1 | - | 25 | MHz |
| | | external clock frequency if on-chip PLL is used | 10 | - | 25 | MHz |
| | | external clock frequency if on-chip bootloader is used for initial code download | 10 | - | 25 | MHz |
| $T_{cy(clk)}$ | clock cycle time | | 20 | - | 1000 | ns |
| t_{CHCX} | clock HIGH time | | $T_{cy(clk)} \times 0.4$ | - | - | ns |
| t_{CLCX} | clock LOW time | | $T_{cy(clk)} \times 0.4$ | - | - | ns |
| t_{CLCH} | clock rise time | | - | - | 5 | ns |
| t_{CHCL} | clock fall time | | - | - | 5 | ns |
| Port pins (except P0.2 and P0.3) | | | | | | |
| t_r | rise time | | - | 10 | - | ns |
| t_f | fall time | | - | 10 | - | ns |
| I²C-bus pins (P0.2 and P0.3) | | | | | | |
| t_f | fall time | V_{IH} to V_{IL} | ^[2] $20 + 0.1 \times C_b$ | - | - | ns |

[1] Parameters are valid over operating temperature range unless otherwise specified.

[2] Bus capacitance C_b in pF, from 10 pF to 400 pF.

Table 14. External memory interface dynamic characteristics

$C_L = 25\text{ pF}$; $T_{amb} = 40\text{ }^\circ\text{C}$.

| Symbol | Parameter | Conditions | Min | Typ | Max | Unit |
|--|--|------------|--|-----|--------------------------------------|------|
| Common to read and write cycles | | | | | | |
| t_{CHAV} | XCLK HIGH to address valid time | | - | - | 10 | ns |
| t_{CHCSL} | XCLK HIGH to \overline{CS} LOW time | | - | - | 10 | ns |
| t_{CHCSH} | XCLK HIGH to \overline{CS} HIGH time | | - | - | 10 | ns |
| t_{CHANV} | XCLK HIGH to address invalid time | | - | - | 10 | ns |
| Read cycle parameters | | | | | | |
| t_{CSLAV} | \overline{CS} LOW to address valid time | | [1] -5 | - | +10 | ns |
| t_{OELAV} | \overline{OE} LOW to address valid time | | [1] -5 | - | +10 | ns |
| t_{CSLOEL} | \overline{CS} LOW to \overline{OE} LOW time | | -5 | - | +5 | ns |
| t_{am} | memory access time | | [2][3] $(T_{cy(CCLK)} \times (2 + WST1)) +$ [4] (-20) | - | - | ns |
| $t_{am(ibr)}$ | memory access time (initial burst-ROM) | | [2][3] $(T_{cy(CCLK)} \times (2 + WST1)) +$ [4] (-20) | - | - | ns |
| $t_{am(sbr)}$ | memory access time (subsequent burst-ROM) | | [2][5] $T_{cy(CCLK)} + (-20)$ | - | - | ns |
| $t_{h(D)}$ | data hold time | | [6] 0 | - | - | ns |
| t_{CSHOEH} | \overline{CS} HIGH to \overline{OE} HIGH time | | -5 | - | +5 | ns |
| t_{OEHANV} | \overline{OE} HIGH to address invalid time | | -5 | - | +5 | ns |
| t_{CHOEL} | XCLK HIGH to \overline{OE} LOW time | | -5 | - | +5 | ns |
| t_{CHOEH} | XCLK HIGH to \overline{OE} HIGH time | | -5 | - | +5 | ns |
| Write cycle parameters | | | | | | |
| t_{AVCSL} | address valid to \overline{CS} LOW time | | [1] $T_{cy(CCLK)} - 10$ | - | - | ns |
| t_{CSLDV} | \overline{CS} LOW to data valid time | | -5 | - | +5 | ns |
| t_{CSLWEL} | \overline{CS} LOW to \overline{WE} LOW time | | -5 | - | +5 | ns |
| $t_{CSLBLSL}$ | \overline{CS} LOW to \overline{BLS} LOW time | | -5 | - | +5 | ns |
| t_{WELDV} | \overline{WE} LOW to data valid time | | -5 | - | +5 | ns |
| t_{CSLDV} | \overline{CS} LOW to data valid time | | -5 | - | +5 | ns |
| t_{WELWEH} | \overline{WE} LOW to \overline{WE} HIGH time | | [2][4] $T_{cy(CCLK)} \times (1 + WST2) - 5$ | - | $T_{cy(CCLK)} \times (1 + WST2) + 5$ | ns |
| $t_{BLSLBLSH}$ | \overline{BLS} LOW to \overline{BLS} HIGH time | | [2][4] $T_{cy(CCLK)} \times (1 + WST2) - 5$ | - | $T_{cy(CCLK)} \times (1 + WST2) + 5$ | ns |
| t_{WEHANV} | \overline{WE} HIGH to address invalid time | | [2] $T_{cy(CCLK)} - 5$ | - | $T_{cy(CCLK)} + 5$ | ns |
| t_{WEHDNV} | \overline{WE} HIGH to data invalid time | | [2] $(2 \times T_{cy(CCLK)}) - 5$ | - | $(2 \times T_{cy(CCLK)}) + 5$ | ns |
| $t_{BLSHANV}$ | \overline{BLS} HIGH to address invalid time | | [2] $T_{cy(CCLK)} - 5$ | - | $T_{cy(CCLK)} + 5$ | ns |

Table 14. External memory interface dynamic characteristics ...continued

$C_L = 25 \text{ pF}$; $T_{amb} = 40 \text{ }^\circ\text{C}$.

| Symbol | Parameter | Conditions | Min | Typ | Max | Unit |
|----------------------|---|------------|--|-----|--------------------------------------|------|
| t_{BLSHDNV} | $\overline{\text{BLS}}$ HIGH to data invalid time | | [2] $(2 \times T_{\text{cy(CCLK)}}) - 5$ | - | $(2 \times T_{\text{cy(CCLK)}}) + 5$ | ns |
| t_{CHDV} | XCLK HIGH to data valid time | | - | - | 10 | ns |
| t_{CHWEL} | XCLK HIGH to $\overline{\text{WE}}$ LOW time | | - | - | 10 | ns |
| t_{CHBLSL} | XCLK HIGH to $\overline{\text{BLS}}$ LOW time | | - | - | 10 | ns |
| t_{CHWEH} | XCLK HIGH to $\overline{\text{WE}}$ HIGH time | | - | - | 10 | ns |
| t_{CHBLSH} | XCLK HIGH to $\overline{\text{BLS}}$ HIGH time | | - | - | 10 | ns |
| t_{CHDNV} | XCLK HIGH to data invalid time | | - | - | 10 | ns |

[1] Except on initial access, in which case the address is set up $T_{\text{cy(CCLK)}}$ earlier.

[2] $T_{\text{cy(CCLK)}} = 1/\text{CCLK}$.

[3] Latest of address valid, $\overline{\text{CS}}$ LOW, $\overline{\text{OE}}$ LOW to data valid.

[4] See the *LPC2210/20 user manual UM10114_1* for a description of the WSTn bits.

[5] Address valid to data valid.

[6] Earliest of $\overline{\text{CS}}$ HIGH, $\overline{\text{OE}}$ HIGH, address change to data invalid.

Table 15. Standard read access specifications

| Access cycle | Max frequency | WST setting WST ≥ 0 ; round up to integer | Memory access time requirement |
|----------------------------|---|--|---|
| standard read | $f_{\text{MAX}} \leq \frac{2 + \text{WST1}}{t_{\text{RAM}} + 20 \text{ ns}}$ | $\text{WST1} \geq \frac{t_{\text{RAM}} + 20 \text{ ns}}{t_{\text{cy(CCLK)}}} - 2$ | $t_{\text{RAM}} \leq t_{\text{cy(CCLK)}} \times (2 + \text{WST1}) - 20 \text{ ns}$ |
| standard write | $f_{\text{MAX}} \leq \frac{1 + \text{WST2}}{t_{\text{WRITE}} + 5 \text{ ns}}$ | $\text{WST2} \geq \frac{t_{\text{WRITE}} - t_{\text{CYC}} + 5}{t_{\text{cy(CCLK)}}}$ | $t_{\text{WRITE}} \leq t_{\text{cy(CCLK)}} \times (1 + \text{WST2}) - 5 \text{ ns}$ |
| burst read - initial | $f_{\text{MAX}} \leq \frac{2 + \text{WST1}}{t_{\text{INIT}} + 20 \text{ ns}}$ | $\text{WST1} \geq \frac{t_{\text{INIT}} + 20 \text{ ns}}{t_{\text{cy(CCLK)}}} - 2$ | $t_{\text{INIT}} \leq t_{\text{cy(CCLK)}} \times (2 + \text{WST1}) - 20 \text{ ns}$ |
| burst read - subsequent 3x | $f_{\text{MAX}} \leq \frac{1}{t_{\text{ROM}} + 20 \text{ ns}}$ | N/A | $t_{\text{ROM}} \leq t_{\text{cy(CCLK)}} - 20 \text{ ns}$ |

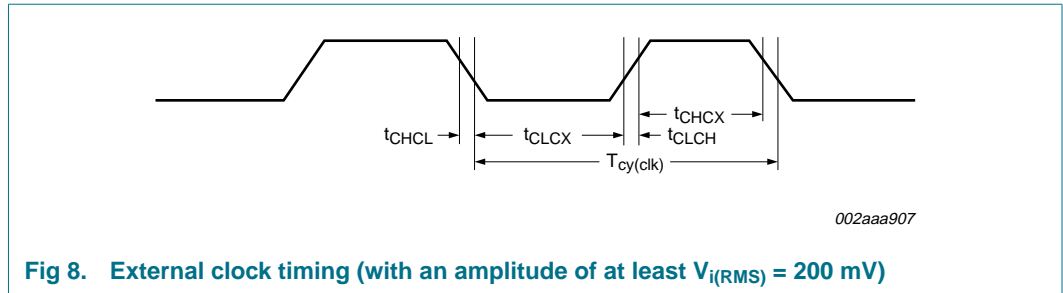

9.2 LPC2210 power consumption measurements

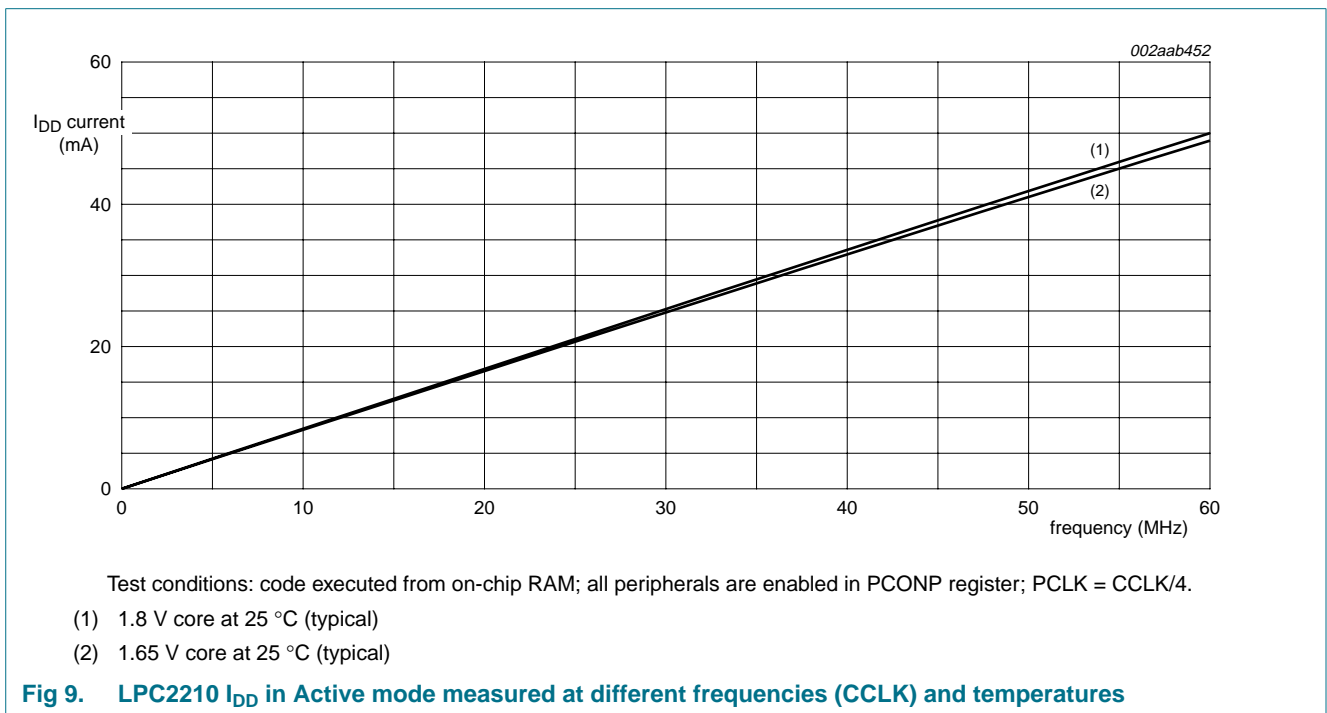

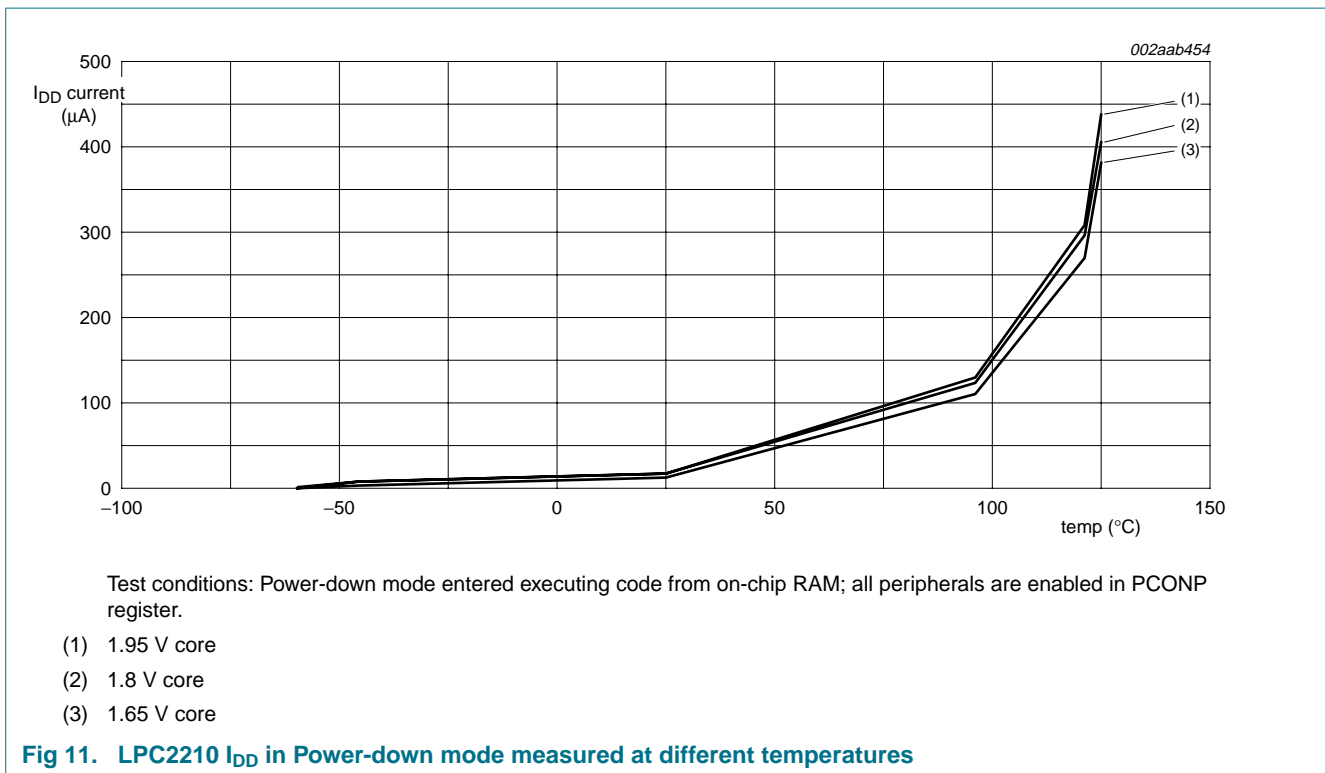
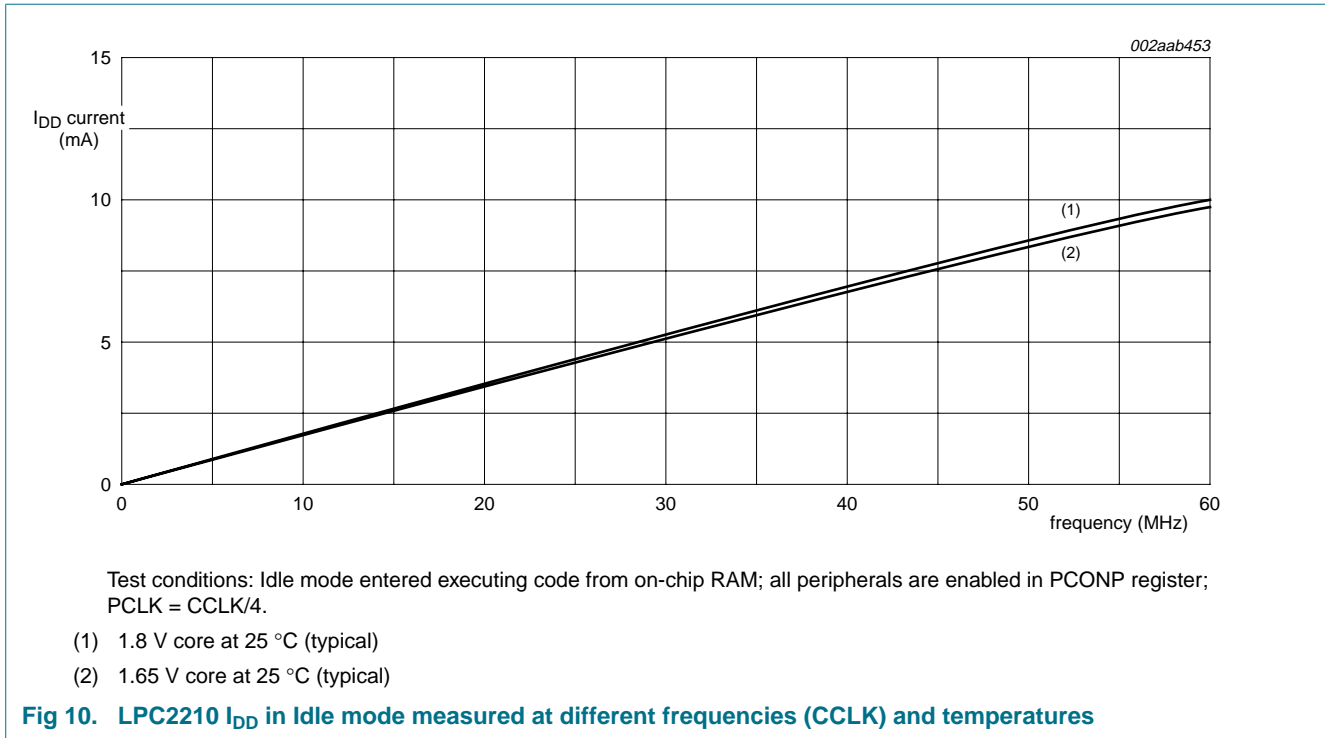

9.3 LPC2220 and LPC2210/01 power consumption measurements

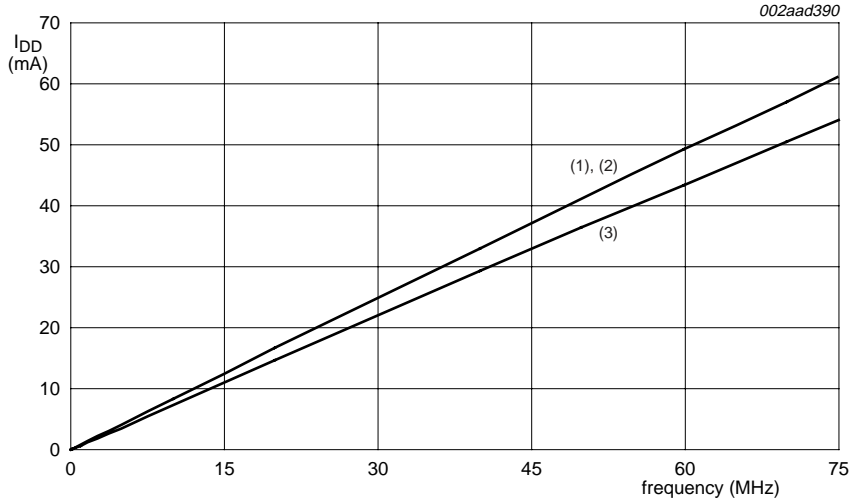

Test conditions: code executed from on-chip RAM; all peripherals are enabled in PCONP register; PCLK = CCLK/4.

- (1) 1.8 V core at 85 °C (typical)
- (2) 1.8 V core at 25 °C (typical)
- (3) 1.65 V core at 25 °C (typical)

Fig 12. LPC2220 and LPC2210/01 I_{DD} in Active mode measured at different frequencies (CCLK) and temperatures

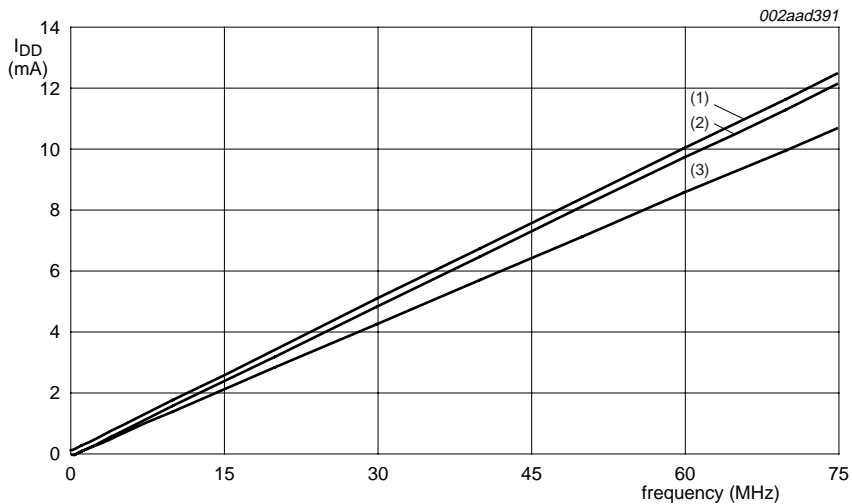

Test conditions: Idle mode entered executing code from on-chip RAM; all peripherals are enabled in PCONP register; PCLK = CCLK/4.

- (1) 1.8 V core at 85 °C (typical)
- (2) 1.8 V core at 25 °C (typical)
- (3) 1.65 V core at 25 °C (typical)

Fig 13. LPC2220 and LPC2210/01 I_{DD} in Idle mode measured at different frequencies (CCLK) and temperatures

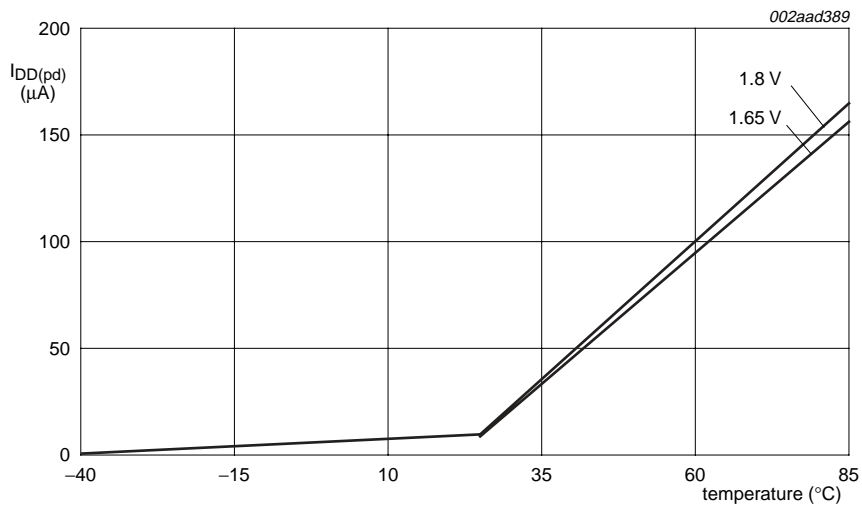

Test conditions: Power-down mode entered executing code from on-chip RAM; all peripherals are enabled in PCONP register.

Fig 14. LPC2220 and LPC2210/01 I_{DD} in Power-down mode measured at different temperatures

10. Package outline

LQFP144: plastic low profile quad flat package; 144 leads; body 20 x 20 x 1.4 mm

SOT486-1

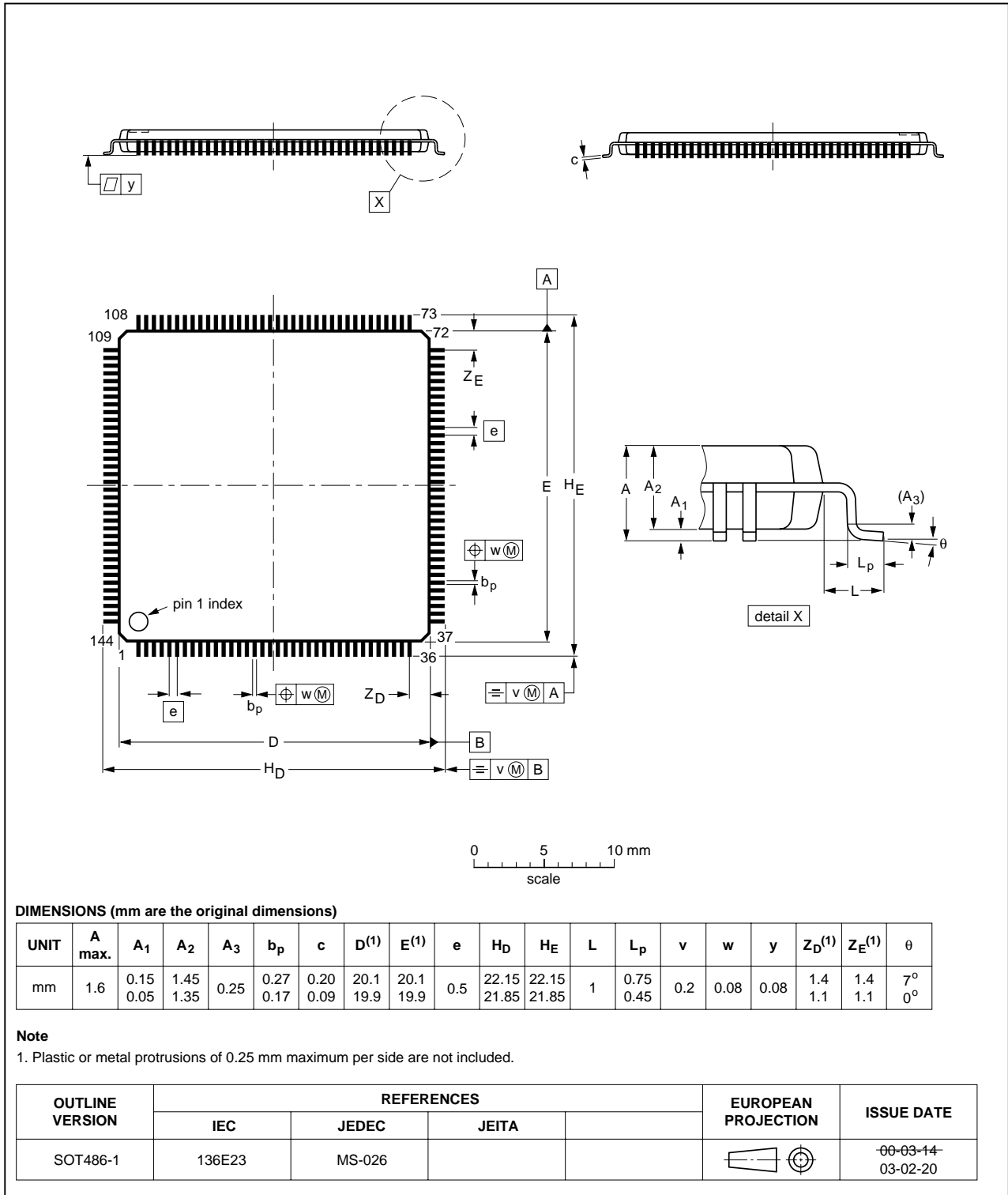

Fig 15. Package outline SOT486-1 (LQFP144)

TFBGA144: plastic thin fine-pitch ball grid array package; 144 balls

SOT569-2

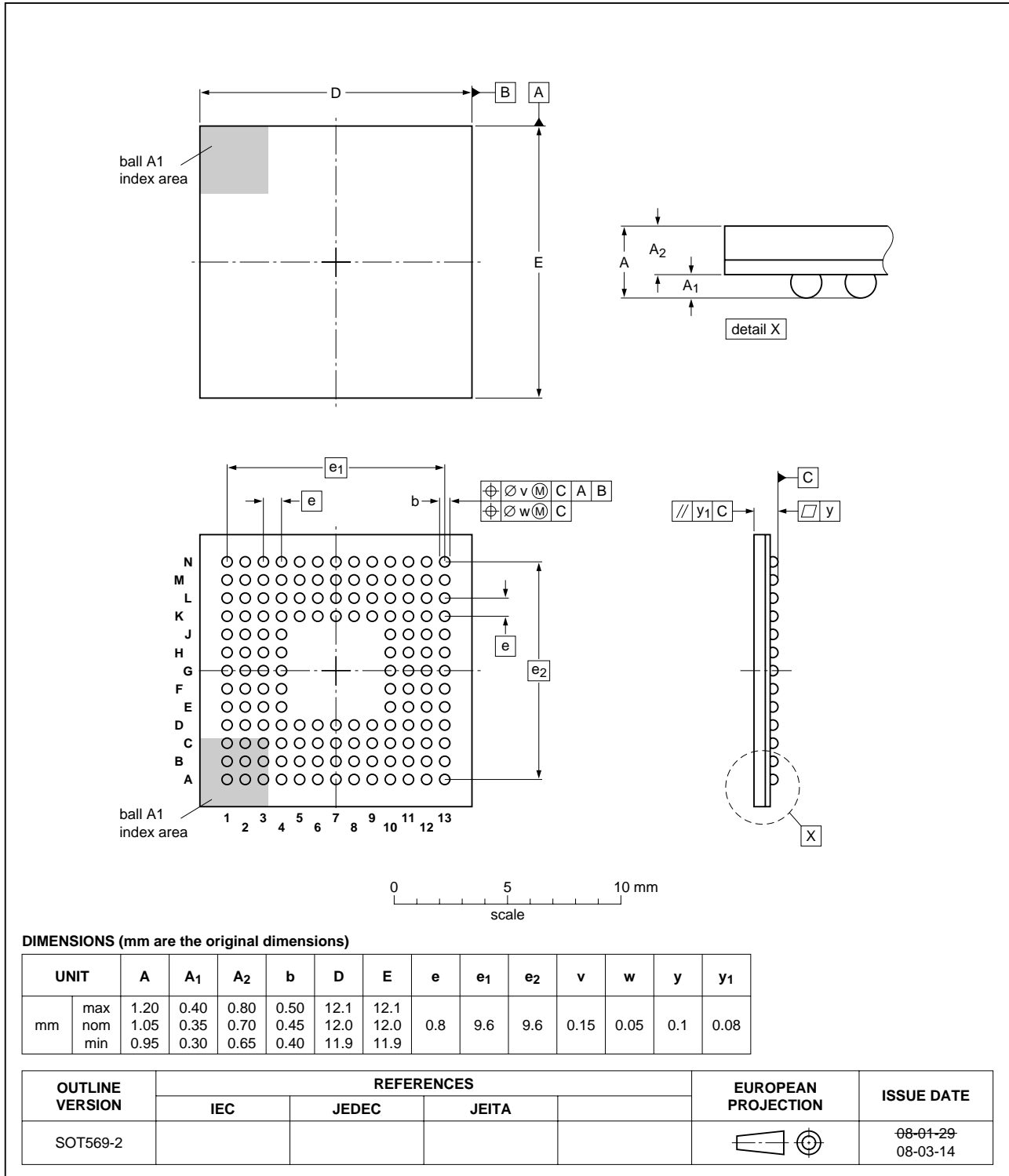

Fig 16. Package outline SOT569-2 (TFBGA144)

11. Abbreviations

Table 16. Acronym list

| Acronym | Description |
|---------|---|
| ADC | Analog-to-Digital Converter |
| AMBA | Advanced Microcontroller Bus Architecture |
| APB | Advanced Peripheral Bus |
| CISC | Complex Instruction Set Computer |
| FIFO | First In, First Out |
| GPIO | General Purpose Input/Output |
| I/O | Input/Output |
| JTAG | Joint Test Action Group |
| PWM | Pulse Width Modulator |
| RISC | Reduced Instruction Set Computer |
| SPI | Serial Peripheral Interface |
| SSI | Serial Synchronous Interface |
| SRAM | Static Random Access Memory |
| TTL | Transistor-Transistor Logic |
| UART | Universal Asynchronous Receiver/Transmitter |

12. Revision history

Table 17. Revision history

| Document ID | Release date | Data sheet status | Change notice | Supersedes |
|----------------|--------------|--------------------|---------------|--|
| LPC2210_2220_6 | 20081211 | Product data sheet | - | LPC2210_2220_5 |
| Modifications: | | | | |
| | | | | <ul style="list-style-type: none"> • Figure 8 “External clock timing (with an amplitude of at least $V_{i(RMS)} = 200\text{ mV}$)”: removed figure note row “$V_{DD} = 1.8\text{ V}$”, updated graphic and figure title. • Table 11 “Static characteristics”: V_{hys}, moved 0.4 from Typ to Min column. • Table 11 “Static characteristics”: modified Table note 8. • Maximum frequency f_{osc} for external oscillator and external crystal updated. • Changed SOT569-1 to SOT569-2. • Added overbar to indicate LOW-active for \overline{BLSn}, \overline{CSn}, \overline{OE}, and \overline{WE}. |
| LPC2210_2220_5 | 20071220 | Product data sheet | - | LPC2210_2220_4 |
| Modifications: | | | | |
| | | | | <ul style="list-style-type: none"> • LPC2210FBD144/01 added. • New power consumption measurements for LPC2220 and LPC2210/01 included. |
| LPC2210_2220_4 | 20071002 | Product data sheet | - | LPC2210_2220_3 |
| LPC2210_2220_3 | 20070213 | Product data sheet | - | LPC2210_2220_2 |
| LPC2210_2220_2 | 20050530 | Product data sheet | - | LPC2210-01 |
| LPC2210-01 | 20040209 | Preliminary data | - | - |

13. Legal information

13.1 Data sheet status

| Document status ^{[1][2]} | Product status ^[3] | Definition |
|-----------------------------------|-------------------------------|---|
| Objective [short] data sheet | Development | This document contains data from the objective specification for product development. |
| Preliminary [short] data sheet | Qualification | This document contains data from the preliminary specification. |
| Product [short] data sheet | Production | This document contains the product specification. |

[1] Please consult the most recently issued document before initiating or completing a design.

[2] The term 'short data sheet' is explained in section "Definitions".

[3] The product status of device(s) described in this document may have changed since this document was published and may differ in case of multiple devices. The latest product status information is available on the Internet at URL <http://www.nxp.com>.

13.2 Definitions

Draft — The document is a draft version only. The content is still under internal review and subject to formal approval, which may result in modifications or additions. NXP Semiconductors does not give any representations or warranties as to the accuracy or completeness of information included herein and shall have no liability for the consequences of use of such information.

Short data sheet — A short data sheet is an extract from a full data sheet with the same product type number(s) and title. A short data sheet is intended for quick reference only and should not be relied upon to contain detailed and full information. For detailed and full information see the relevant full data sheet, which is available on request via the local NXP Semiconductors sales office. In case of any inconsistency or conflict with the short data sheet, the full data sheet shall prevail.

13.3 Disclaimers

General — Information in this document is believed to be accurate and reliable. However, NXP Semiconductors does not give any representations or warranties, expressed or implied, as to the accuracy or completeness of such information and shall have no liability for the consequences of use of such information.

Right to make changes — NXP Semiconductors reserves the right to make changes to information published in this document, including without limitation specifications and product descriptions, at any time and without notice. This document supersedes and replaces all information supplied prior to the publication hereof.

Suitability for use — NXP Semiconductors products are not designed, authorized or warranted to be suitable for use in medical, military, aircraft, space or life support equipment, nor in applications where failure or malfunction of an NXP Semiconductors product can reasonably be expected

to result in personal injury, death or severe property or environmental damage. NXP Semiconductors accepts no liability for inclusion and/or use of NXP Semiconductors products in such equipment or applications and therefore such inclusion and/or use is at the customer's own risk.

Applications — Applications that are described herein for any of these products are for illustrative purposes only. NXP Semiconductors makes no representation or warranty that such applications will be suitable for the specified use without further testing or modification.

Limiting values — Stress above one or more limiting values (as defined in the Absolute Maximum Ratings System of IEC 60134) may cause permanent damage to the device. Limiting values are stress ratings only and operation of the device at these or any other conditions above those given in the Characteristics sections of this document is not implied. Exposure to limiting values for extended periods may affect device reliability.

Terms and conditions of sale — NXP Semiconductors products are sold subject to the general terms and conditions of commercial sale, as published at <http://www.nxp.com/profile/terms>, including those pertaining to warranty, intellectual property rights infringement and limitation of liability, unless explicitly otherwise agreed to in writing by NXP Semiconductors. In case of any inconsistency or conflict between information in this document and such terms and conditions, the latter will prevail.

No offer to sell or license — Nothing in this document may be interpreted or construed as an offer to sell products that is open for acceptance or the grant, conveyance or implication of any license under any copyrights, patents or other industrial or intellectual property rights.

13.4 Trademarks

Notice: All referenced brands, product names, service names and trademarks are the property of their respective owners.

I²C-bus — logo is a trademark of NXP B.V.

14. Contact information

For more information, please visit: <http://www.nxp.com>

For sales office addresses, please send an email to: salesaddresses@nxp.com

15. Contents

| | | | | | |
|----------|---|-----------|-----------|--|-----------|
| 1 | General description | 1 | 6.18.1 | Features | 27 |
| 2 | Features | 1 | 6.19 | Pulse width modulator | 27 |
| 2.1 | Key features | 1 | 6.19.1 | Features | 28 |
| 3 | Ordering information | 2 | 6.20 | System control | 28 |
| 3.1 | Ordering options | 3 | 6.20.1 | Crystal oscillator | 28 |
| 4 | Block diagram | 4 | 6.20.2 | PLL | 29 |
| 5 | Pinning information | 5 | 6.20.3 | Reset and wake-up timer | 29 |
| 5.1 | Pinning | 5 | 6.20.4 | External interrupt inputs | 29 |
| 5.2 | Pin description | 8 | 6.20.5 | Memory mapping control | 30 |
| 6 | Functional description | 15 | 6.20.6 | Power control | 30 |
| 6.1 | Architectural overview | 15 | 6.20.7 | APB | 30 |
| 6.2 | On-chip SRAM | 15 | 6.21 | Emulation and debugging | 30 |
| 6.3 | Memory map | 15 | 6.21.1 | EmbeddedICE | 31 |
| 6.4 | Interrupt controller | 16 | 6.21.2 | Embedded trace | 31 |
| 6.4.1 | Interrupt sources | 17 | 6.21.3 | RealMonitor | 31 |
| 6.5 | Pin connect block | 18 | 7 | Limiting values | 32 |
| 6.6 | Pin function select register 0 (PINSEL0 - 0xE002 C000) | 18 | 8 | Static characteristics | 33 |
| 6.7 | Pin function select register 1 (PINSEL1 - 0xE002 C004) | 20 | 9 | Dynamic characteristics | 37 |
| 6.8 | Pin function select register 2 (PINSEL2 - 0xE002 C014) | 22 | 9.1 | Timing | 40 |
| 6.9 | External memory controller | 23 | 9.2 | LPC2210 power consumption measurements | 41 |
| 6.10 | General purpose parallel I/O | 23 | 9.3 | LPC2220 and LPC2210/01 power consumption measurements | 43 |
| 6.10.1 | Features | 23 | 10 | Package outline | 45 |
| 6.11 | 10-bit ADC | 23 | 11 | Abbreviations | 47 |
| 6.11.1 | Features | 23 | 12 | Revision history | 48 |
| 6.11.2 | ADC features available in LPC2210/01 and LPC2220 only | 24 | 13 | Legal information | 49 |
| 6.12 | UARTs | 24 | 13.1 | Data sheet status | 49 |
| 6.12.1 | Features | 24 | 13.2 | Definitions | 49 |
| 6.12.2 | UART features available in LPC2210/01 and LPC2220 only | 24 | 13.3 | Disclaimers | 49 |
| 6.13 | I ² C-bus serial I/O controller | 24 | 13.4 | Trademarks | 49 |
| 6.13.1 | Features | 24 | 14 | Contact information | 49 |
| 6.14 | SPI serial I/O controller | 25 | 15 | Contents | 50 |
| 6.14.1 | Features | 25 | | | |
| 6.15 | SSP controller | 25 | | | |
| 6.15.1 | Features | 25 | | | |
| 6.15.2 | Description | 25 | | | |
| 6.16 | General purpose timers | 26 | | | |
| 6.16.1 | Features | 26 | | | |
| 6.16.2 | Features available in LPC2210/01 and LPC2220 only | 26 | | | |
| 6.17 | Watchdog timer | 27 | | | |
| 6.17.1 | Features | 27 | | | |
| 6.18 | Real-time clock | 27 | | | |

Please be aware that important notices concerning this document and the product(s) described herein, have been included in section 'Legal information'.

