

## 2N7000 / 2N7002 / NDS7002A N-Channel Enhancement Mode Field Effect Transistor

### General Description

These N-Channel enhancement mode field effect transistors are produced using Fairchild's proprietary, high cell density, DMOS technology. These products have been designed to minimize on-state resistance while provide rugged, reliable, and fast switching performance. They can be used in most applications requiring up to 400mA DC and can deliver pulsed currents up to 2A. These products are particularly suited for low voltage, low current applications such as small servo motor control, power MOSFET gate drivers, and other switching applications.

### Features

- High density cell design for low  $R_{DS(ON)}$ .
- Voltage controlled small signal switch.
- Rugged and reliable.
- High saturation current capability.

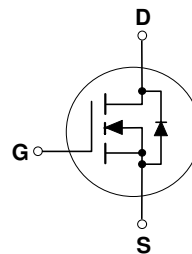
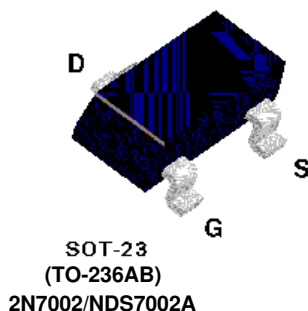
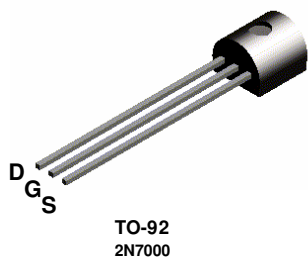

### Absolute Maximum Ratings $T_A = 25^\circ\text{C}$ unless otherwise noted

Symbol	Parameter	2N7000	2N7002	NDS7002A	Units
$V_{DSS}$	Drain-Source Voltage	60			V
$V_{DGR}$	Drain-Gate Voltage ( $R_{GS} \leq 1 \text{ M}\Omega$ )	60			V
$V_{GSS}$	Gate-Source Voltage - Continuous	$\pm 20$			V
	- Non Repetitive ( $t_p < 50\mu\text{s}$ )	$\pm 40$			
$I_D$	Maximum Drain Current - Continuous	200	115	280	mA
	- Pulsed	500	800	1500	
$P_D$	Maximum Power Dissipation	400	200	300	mW
	Derated above $25^\circ\text{C}$	3.2	1.6	2.4	mW/ $^\circ\text{C}$
$T_J, T_{STG}$	Operating and Storage Temperature Range	-55 to 150			$^\circ\text{C}$
$T_L$	Maximum Lead Temperature for Soldering Purposes, 1/16" from Case for 10 Seconds	300			$^\circ\text{C}$

### THERMAL CHARACTERISTICS

$R_{\theta JA}$	Thermal Resistance, Junction-to-Ambient	312.5	625	417	$^\circ\text{C}/\text{W}$
-----------------	---	-------	-----	-----	---------------------------

**Electrical Characteristics**  $T_A = 25^\circ\text{C}$  unless otherwise noted

Symbol	Parameter	Conditions	Type	Min	Typ	Max	Units
<b>OFF CHARACTERISTICS</b>							
$BV_{DSS}$	Drain-Source Breakdown Voltage	$V_{GS} = 0\text{ V}, I_D = 10\ \mu\text{A}$	All	60			V
$I_{DSS}$	Zero Gate Voltage Drain Current	$V_{DS} = 48\text{ V}, V_{GS} = 0\text{ V}$	2N7000			1	$\mu\text{A}$
		$T_J = 125^\circ\text{C}$				1	$\text{mA}$
		$V_{DS} = 60\text{ V}, V_{GS} = 0\text{ V}$	2N7002 NDS7002A			1	$\mu\text{A}$
		$T_J = 125^\circ\text{C}$				0.5	$\text{mA}$
$I_{GSSF}$	Gate - Body Leakage, Forward	$V_{GS} = 15\text{ V}, V_{DS} = 0\text{ V}$	2N7000			10	$\text{nA}$
		$V_{GS} = 20\text{ V}, V_{DS} = 0\text{ V}$	2N7002 NDS7002A			100	$\text{nA}$
$I_{GSSR}$	Gate - Body Leakage, Reverse	$V_{GS} = -15\text{ V}, V_{DS} = 0\text{ V}$	2N7000			-10	$\text{nA}$
		$V_{GS} = -20\text{ V}, V_{DS} = 0\text{ V}$	2N7002 NDS7002A			-100	$\text{nA}$
<b>ON CHARACTERISTICS</b> (Note 1)							
$V_{GS(th)}$	Gate Threshold Voltage	$V_{DS} = V_{GS}, I_D = 1\text{ mA}$	2N7000	0.8	2.1	3	V
		$V_{DS} = V_{GS}, I_D = 250\ \mu\text{A}$	2N7002 NDS7002A	1	2.1	2.5	
$R_{DS(ON)}$	Static Drain-Source On-Resistance	$V_{GS} = 10\text{ V}, I_D = 500\text{ mA}$	2N7000		1.2	5	$\Omega$
		$T_J = 125^\circ\text{C}$			1.9	9	
		$V_{GS} = 4.5\text{ V}, I_D = 75\text{ mA}$			1.8	5.3	
		$V_{GS} = 10\text{ V}, I_D = 500\text{ mA}$	2N7002		1.2	7.5	
		$T_J = 100^\circ\text{C}$			1.7	13.5	
		$V_{GS} = 5.0\text{ V}, I_D = 50\text{ mA}$			1.7	7.5	
		$T_J = 100^\circ\text{C}$			2.4	13.5	
		$V_{GS} = 10\text{ V}, I_D = 500\text{ mA}$	NDS7002A		1.2	2	
	$T_J = 125^\circ\text{C}$			2	3.5		
	$V_{GS} = 5.0\text{ V}, I_D = 50\text{ mA}$			1.7	3		
	$T_J = 125^\circ\text{C}$			2.8	5		
$V_{DS(ON)}$	Drain-Source On-Voltage	$V_{GS} = 10\text{ V}, I_D = 500\text{ mA}$	2N7000		0.6	2.5	V
		$V_{GS} = 4.5\text{ V}, I_D = 75\text{ mA}$			0.14	0.4	
		$V_{GS} = 10\text{ V}, I_D = 500\text{ mA}$	2N7002		0.6	3.75	
		$V_{GS} = 5.0\text{ V}, I_D = 50\text{ mA}$			0.09	1.5	
		$V_{GS} = 10\text{ V}, I_D = 500\text{ mA}$	NDS7002A		0.6	1	
		$V_{GS} = 5.0\text{ V}, I_D = 50\text{ mA}$			0.09	0.15	

**Electrical Characteristics**  $T_A = 25^\circ\text{C}$  unless otherwise noted

Symbol	Parameter	Conditions	Type	Min	Typ	Max	Units
<b>ON CHARACTERISTICS</b> Continued (Note 1)							
$I_{D(\text{ON})}$	On-State Drain Current	$V_{GS} = 4.5\text{ V}, V_{DS} = 10\text{ V}$	2N7000	75	600		mA
		$V_{GS} = 10\text{ V}, V_{DS} \geq 2 V_{DS(\text{on})}$	2N7002	500	2700		
		$V_{GS} = 10\text{ V}, V_{DS} \geq 2 V_{DS(\text{on})}$	NDS7002A	500	2700		
$g_{FS}$	Forward Transconductance	$V_{DS} = 10\text{ V}, I_D = 200\text{ mA}$	2N7000	100	320		mS
		$V_{DS} \geq 2 V_{DS(\text{on})}, I_D = 200\text{ mA}$	2N7002	80	320		
		$V_{DS} \geq 2 V_{DS(\text{on})}, I_D = 200\text{ mA}$	NDS7002A	80	320		
<b>DYNAMIC CHARACTERISTICS</b>							
$C_{iss}$	Input Capacitance	$V_{DS} = 25\text{ V}, V_{GS} = 0\text{ V},$ $f = 1.0\text{ MHz}$	All		20	50	pF
$C_{oss}$	Output Capacitance		All		11	25	pF
$C_{rss}$	Reverse Transfer Capacitance		All		4	5	pF
$t_{on}$	Turn-On Time	$V_{DD} = 15\text{ V}, R_L = 25\ \Omega,$ $I_D = 500\text{ mA}, V_{GS} = 10\text{ V},$ $R_{GEN} = 25$	2N7000			10	ns
		$V_{DD} = 30\text{ V}, R_L = 150\ \Omega,$ $I_D = 200\text{ mA}, V_{GS} = 10\text{ V},$ $R_{GEN} = 25\ \Omega$	2N7002 NDS7002A			20	
$t_{off}$	Turn-Off Time	$V_{DD} = 15\text{ V}, R_L = 25\ \Omega,$ $I_D = 500\text{ mA}, V_{GS} = 10\text{ V},$ $R_{GEN} = 25$	2N7000			10	ns
		$V_{DD} = 30\text{ V}, R_L = 150\ \Omega,$ $I_D = 200\text{ mA}, V_{GS} = 10\text{ V},$ $R_{GEN} = 25\ \Omega$	2N7002 NDS7002A			20	
<b>DRAIN-SOURCE DIODE CHARACTERISTICS AND MAXIMUM RATINGS</b>							
$I_S$	Maximum Continuous Drain-Source Diode Forward Current		2N7002			115	mA
			NDS7002A			280	
$I_{SM}$	Maximum Pulsed Drain-Source Diode Forward Current		2N7002			0.8	A
			NDS7002A			1.5	
$V_{SD}$	Drain-Source Diode Forward Voltage	$V_{GS} = 0\text{ V}, I_S = 115\text{ mA}$ (Note 1)	2N7002		0.88	1.5	V
		$V_{GS} = 0\text{ V}, I_S = 400\text{ mA}$ (Note 1)	NDS7002A		0.88	1.2	

Note:

 1. Pulse Test: Pulse Width  $\leq 300\ \mu\text{s}$ , Duty Cycle  $\leq 2.0\%$ .

# Typical Electrical Characteristics

2N7000 / 2N7002 / NDS7002A

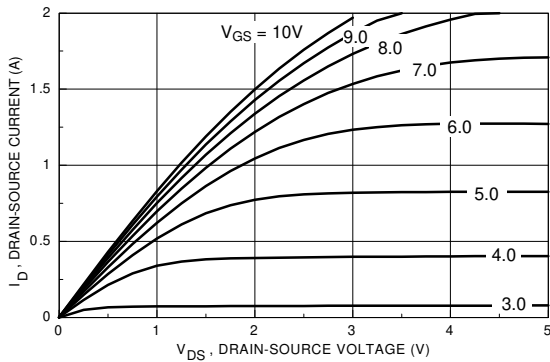

Figure 1. On-Region Characteristics

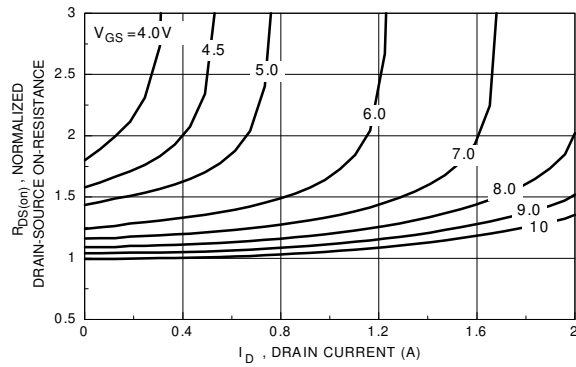

Figure 2. On-Resistance Variation with Gate Voltage and Drain Current

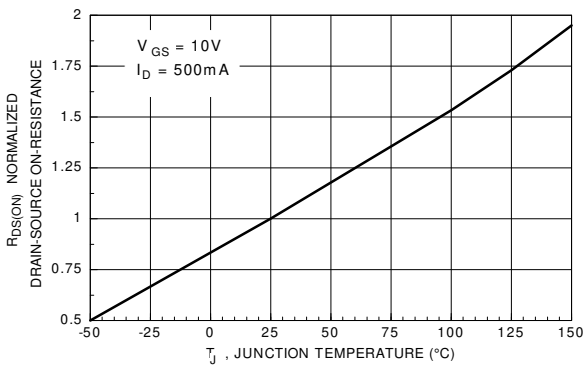

Figure 3. On-Resistance Variation with Temperature

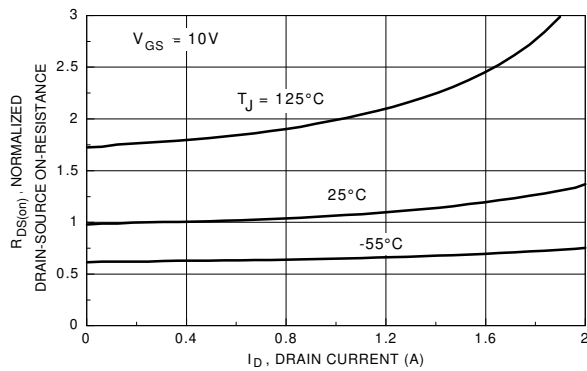

Figure 4. On-Resistance Variation with Drain Current and Temperature

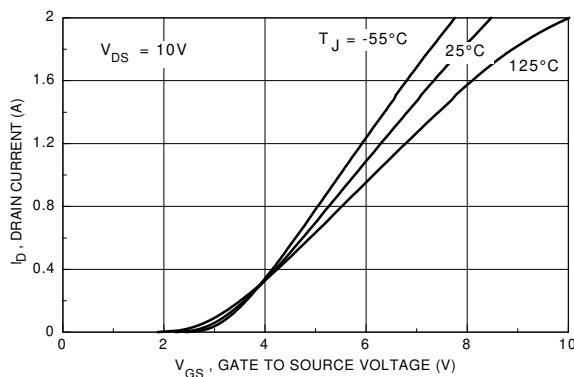

Figure 5. Transfer Characteristics

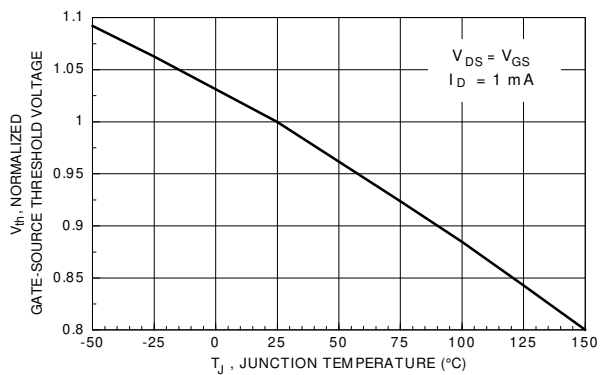

Figure 6. Gate Threshold Variation with Temperature

## Typical Electrical Characteristics (continued)

2N7000 / 2N7002 / NDS7002A

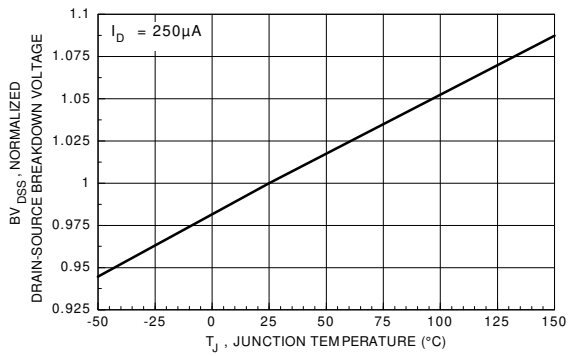

Figure 7. Breakdown Voltage Variation with Temperature

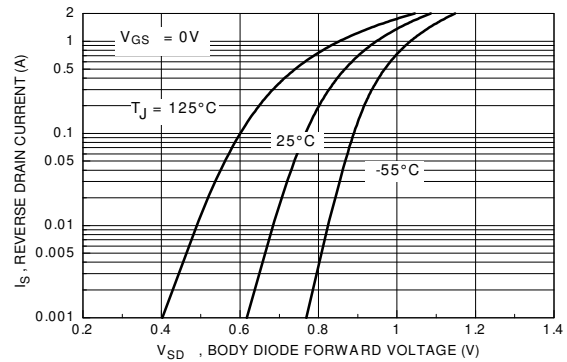

Figure 8. Body Diode Forward Voltage Variation with Reverse Drain Current

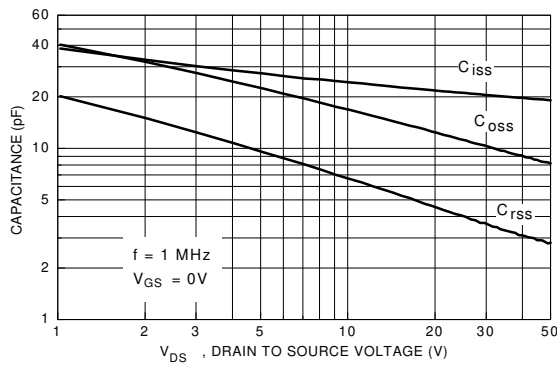

Figure 9. Capacitance Characteristics

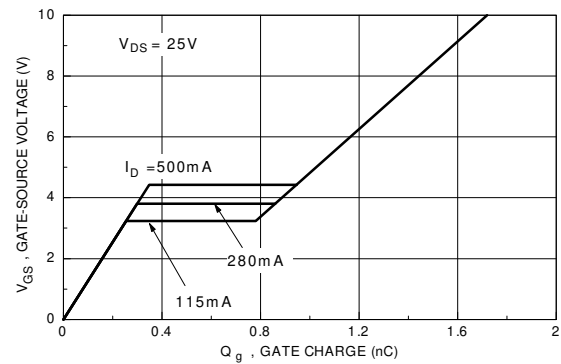

Figure 10. Gate Charge Characteristics

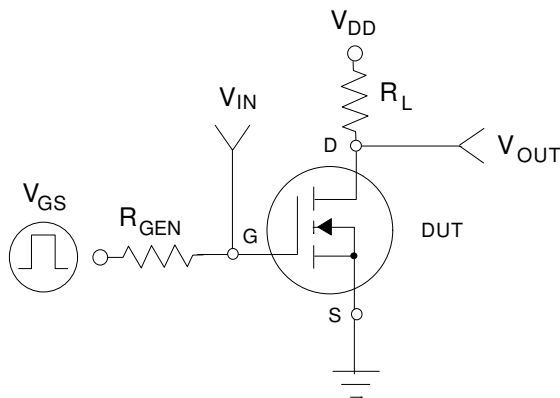

Figure 11.

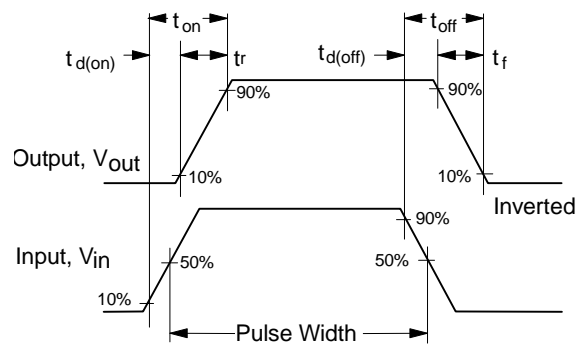
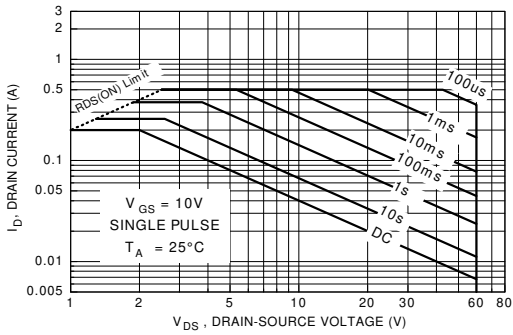
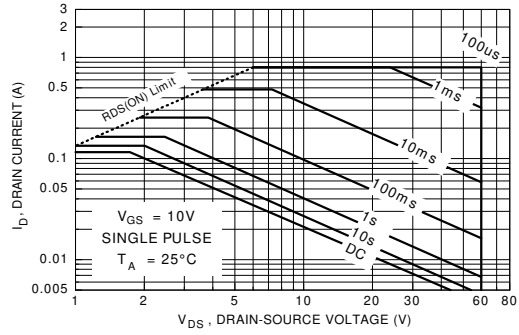

Figure 12. Switching Waveforms

**Typical Electrical Characteristics (continued)**



**Figure 13. 2N7000 Maximum Safe Operating Area**



**Figure 14. 2N7002 Maximum Safe Operating Area**

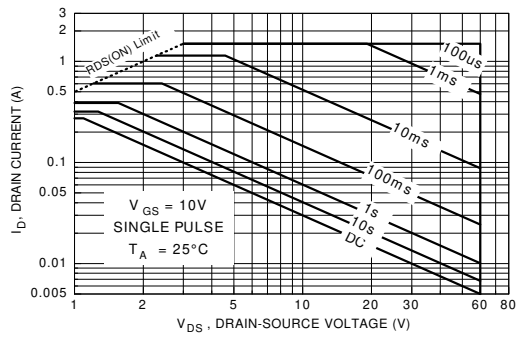

**Figure 15. NDS7000A Maximum Safe Operating Area**

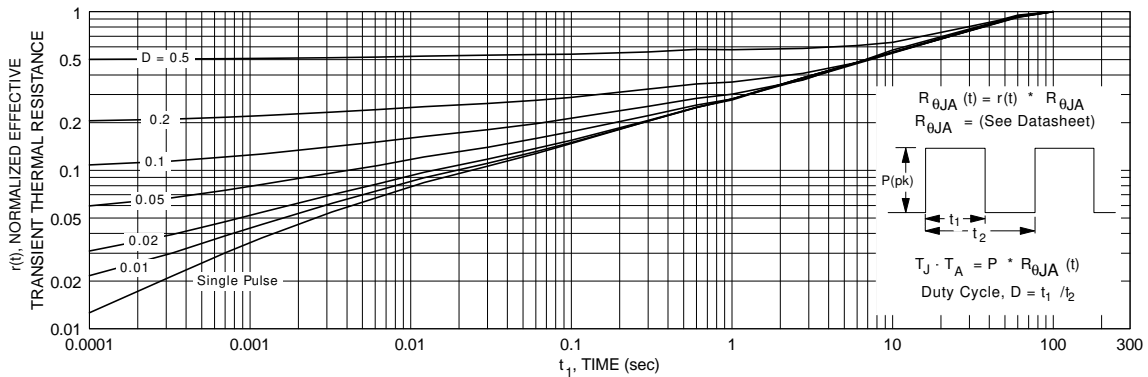

**Figure 16. TO-92, 2N7000 Transient Thermal Response Curve**

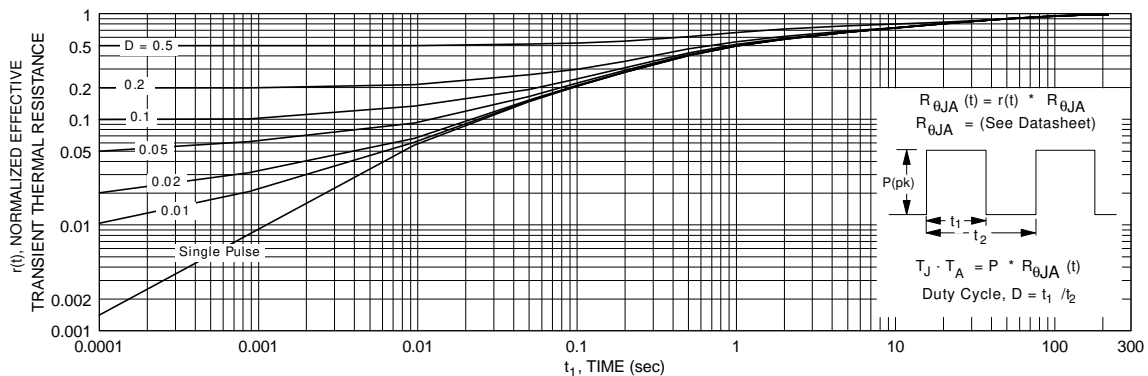

**Figure 17. SOT-23, 2N7002 / NDS7002A Transient Thermal Response Curve**

## TRADEMARKS

The following are registered and unregistered trademarks Fairchild Semiconductor owns or is authorized to use and is not intended to be an exhaustive list of all such trademarks.

ACEx™	FASTr™	PowerTrench®	SyncFET™
Bottomless™	GlobalOptoisolator™	QFET™	TinyLogic™
CoolFET™	GTO™	QST™	UHC™
CROSSVOLT™	HiSeC™	QT Optoelectronics™	VCX™
DOME™	ISOPLANAR™	Quiet Series™	
E <sup>2</sup> CMOS™	MICROWIRE™	SILENT SWITCHER®	
EnSigna™	OPTOLOGIC™	SMART START™	
FACT™	OPTOPLANAR™	SuperSOT™-3	
FACT Quiet Series™	PACMAN™	SuperSOT™-6	
FAST®	POP™	SuperSOT™-8	

## DISCLAIMER

FAIRCHILD SEMICONDUCTOR RESERVES THE RIGHT TO MAKE CHANGES WITHOUT FURTHER NOTICE TO ANY PRODUCTS HEREIN TO IMPROVE RELIABILITY, FUNCTION OR DESIGN. FAIRCHILD DOES NOT ASSUME ANY LIABILITY ARISING OUT OF THE APPLICATION OR USE OF ANY PRODUCT OR CIRCUIT DESCRIBED HEREIN; NEITHER DOES IT CONVEY ANY LICENSE UNDER ITS PATENT RIGHTS, NOR THE RIGHTS OF OTHERS.

## LIFE SUPPORT POLICY

FAIRCHILD'S PRODUCTS ARE NOT AUTHORIZED FOR USE AS CRITICAL COMPONENTS IN LIFE SUPPORT DEVICES OR SYSTEMS WITHOUT THE EXPRESS WRITTEN APPROVAL OF FAIRCHILD SEMICONDUCTOR CORPORATION. As used herein:

1. Life support devices or systems are devices or systems which, (a) are intended for surgical implant into the body, or (b) support or sustain life, or (c) whose failure to perform when properly used in accordance with instructions for use provided in the labeling, can be reasonably expected to result in significant injury to the user.
2. A critical component is any component of a life support device or system whose failure to perform can be reasonably expected to cause the failure of the life support device or system, or to affect its safety or effectiveness.

## PRODUCT STATUS DEFINITIONS

### Definition of Terms

Datasheet Identification	Product Status	Definition
Advance Information	Formative or In Design	This datasheet contains the design specifications for product development. Specifications may change in any manner without notice.
Preliminary	First Production	This datasheet contains preliminary data, and supplementary data will be published at a later date. Fairchild Semiconductor reserves the right to make changes at any time without notice in order to improve design.
No Identification Needed	Full Production	This datasheet contains final specifications. Fairchild Semiconductor reserves the right to make changes at any time without notice in order to improve design.
Obsolete	Not In Production	This datasheet contains specifications on a product that has been discontinued by Fairchild semiconductor. The datasheet is printed for reference information only.