

TPS3600D20, TPS3600D25, TPS3600D33, TPS3600D50 BATTERY-BACKUP SUPERVISORS FOR LOW-POWER PROCESSORS

SLVS336A – DECEMBER 2000 – REVISED APRIL 2001

features

- Supply Current of 40 μ A (Max)
- Precision Supply Voltage Monitor
 - 2.0 V, 2.5 V, 3.3 V, 5.0 V
 - Other Versions on Request
- Watchdog Timer With 800-ms Time-Out
- Backup-Battery Voltage Can Exceed V_{DD}
- Power-On Reset Generator With Fixed 100-ms Reset Delay Time
- Battery OK Output
- Voltage Monitor for Power-Fail or Low-Battery Monitoring
- Manual Switchover to Battery-Backup Mode
- Chip-Enable Gating –3 ns (at $V_{DD} = 5$ V) Max. Propagation Delay
- Manual Reset
- Battery Freshness Seal
- 14-Pin TSSOP Package
- Temperature Range . . . -40°C to 85°C

typical applications

- Fax Machines
- Set-Top Boxes
- Advanced Voice Mail Systems
- Portable Battery Powered Equipment
- Computer Equipment
- Advanced Modems
- Automotive Systems
- Portable Long-Time Monitoring Equipment
- Point of Sale Equipment

TSSOP (PW) Package
(TOP VIEW)

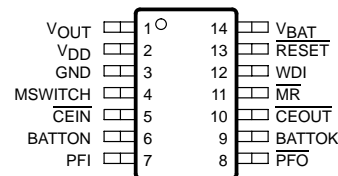

ACTUAL SIZE
(5,10mm x 6,60mm)

typical operating circuit

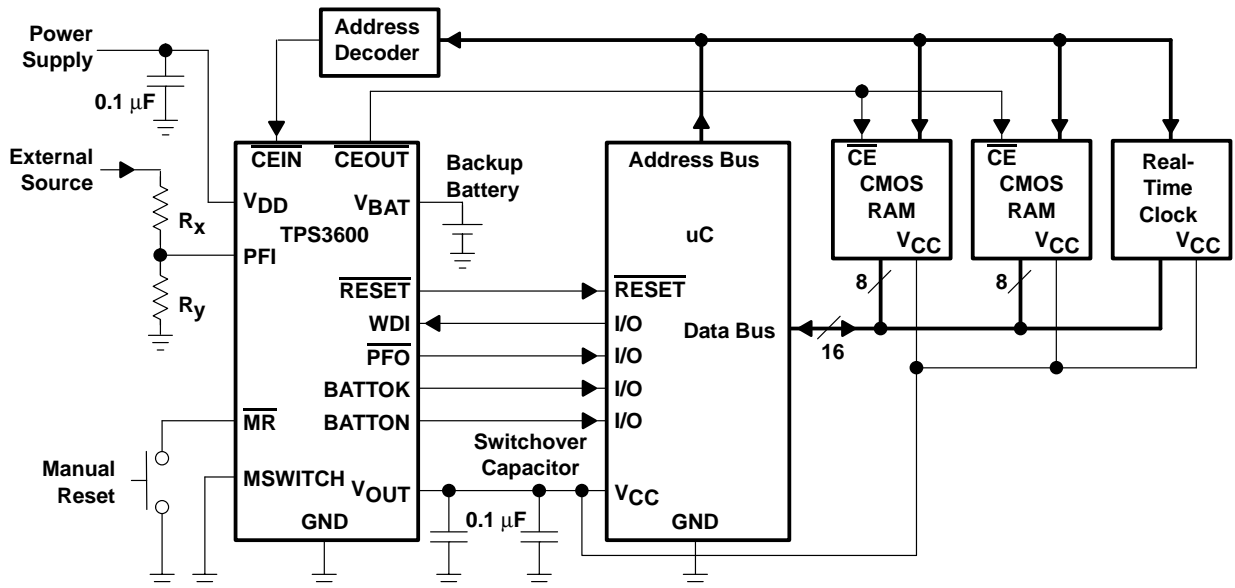

Please be aware that an important notice concerning availability, standard warranty, and use in critical applications of Texas Instruments semiconductor products and disclaimers thereto appears at the end of this data sheet.

PRODUCTION DATA information is current as of publication date. Products conform to specifications per the terms of Texas Instruments standard warranty. Production processing does not necessarily include testing of all parameters.

**TEXAS
INSTRUMENTS**

POST OFFICE BOX 655303 • DALLAS, TEXAS 75265

Copyright © 2001, Texas Instruments Incorporated

TPS3600D20, TPS3600D25, TPS3600D33, TPS3600D50 BATTERY-BACKUP SUPERVISORS FOR LOW-POWER PROCESSORS

SLVS336A – DECEMBER 2000 – REVISED APRIL 2001

description

The TPS3600 family of supervisory circuits monitor and control processor activity. In case of power-fail or brownout conditions, the backup-battery switchover function of TPS3600 allows to run a low-power processor and its peripherals from the installed backup battery without asserting a reset beforehand.

During power on, $\overline{\text{RESET}}$ is asserted when the supply voltage (V_{DD} or V_{BAT}) becomes higher than V_{res} . Thereafter, the supply voltage supervisor monitors V_{OUT} and keeps $\overline{\text{RESET}}$ output active as long as V_{OUT} remains below the threshold voltage (V_{IT}). An internal timer delays the return of the output to the inactive state (high) to ensure proper system reset. This delay timer starts its time-out, after V_{OUT} has risen above the threshold voltage (V_{IT}). In case of a brownout or power failure of both supply sources, a voltage drop below the threshold voltage (V_{IT}) get detected and the output becomes active (low) again.

The product spectrum is designed for supply voltages of 2 V, 2.5 V, 3.3 V, and 5 V. The circuits are available in a 14-pin TSSOP package. They are characterized for operation over a temperature range of -40°C to 85°C .

PACKAGE INFORMATION

| T_A | DEVICE NAME |
|---|-------------|
| -40°C to 85°C | TPS3600D20 |
| | TPS3600D25 |
| | TPS3600D33 |
| | TPS3600D50 |

ordering information application specific versions (see Note)

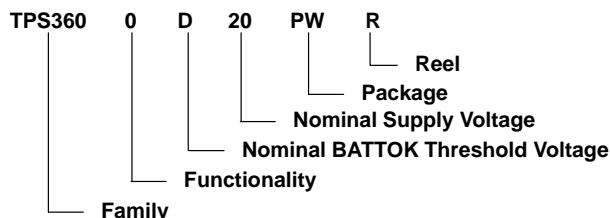

| DEVICE NAME | NOMINAL VOLTAGE, V_{NOM} |
|---------------|-----------------------------------|
| TPS3600x20 PW | 2.0 V |
| TPS3600x25 PW | 2.5 V |
| TPS3600x33 PW | 3.3 V |
| TPS3600x50 PW | 5.0 V |

| DEVICE NAME | NOMINAL BATTOK THRESHOLD VOLTAGE, V_{BOK} |
|----------------|--|
| TPS3600Dxx PW | $V_{\text{IT}} + 7\%$ |
| TPS3600Fxx PW† | $V_{\text{IT}} + 6\%$ |
| TPS3600Hxx PW† | $V_{\text{IT}} + 8\%$ |
| TPS3600Jxx PW† | $V_{\text{IT}} + 10\%$ |

† For the application specific versions, please contact the local TI sales office for availability and lead time.



TPS3600D20, TPS3600D25, TPS3600D33, TPS3600D50 BATTERY-BACKUP SUPERVISORS FOR LOW-POWER PROCESSORS

SLVS336A – DECEMBER 2000 – REVISED APRIL 2001

FUNCTION TABLES

| $V_{DD} > V_{SW}$ | $V_{OUT} > V_{IT}$ | $V_{DD} > V_{BAT}$ | MSWITCH | \overline{MR} | V_{OUT} | BATTON | \overline{RESET} | \overline{CEOUT} |
|-------------------|--------------------|--------------------|---------|-----------------|-----------|--------|--------------------|--------------------|
| 0 | 0 | 0 | 0 | 0 | V_{BAT} | 1 | 0 | DIS |
| 0 | 0 | 0 | 0 | 1 | V_{BAT} | 1 | 0 | DIS |
| 0 | 0 | 0 | 1 | 0 | V_{BAT} | 1 | 0 | DIS |
| 0 | 0 | 0 | 1 | 1 | V_{BAT} | 1 | 0 | DIS |
| 0 | 0 | 1 | 0 | 0 | V_{DD} | 0 | 0 | DIS |
| 0 | 0 | 1 | 0 | 1 | V_{DD} | 0 | 0 | DIS |
| 0 | 0 | 1 | 1 | 0 | V_{BAT} | 1 | 0 | DIS |
| 0 | 0 | 1 | 1 | 1 | V_{BAT} | 1 | 0 | DIS |
| 0 | 1 | 0 | 0 | 0 | V_{BAT} | 1 | 0 | DIS |
| 0 | 1 | 0 | 0 | 1 | V_{BAT} | 1 | 1 | EN |
| 0 | 1 | 0 | 1 | 0 | V_{BAT} | 1 | 0 | DIS |
| 0 | 1 | 0 | 1 | 1 | V_{BAT} | 1 | 1 | EN |
| 0 | 1 | 1 | 0 | 0 | V_{DD} | 0 | 0 | DIS |
| 0 | 1 | 1 | 0 | 1 | V_{DD} | 0 | 1 | EN |
| 0 | 1 | 1 | 1 | 0 | V_{BAT} | 1 | 0 | DIS |
| 0 | 1 | 1 | 1 | 1 | V_{BAT} | 1 | 1 | EN |
| 1 | 1 | 0 | 0 | 0 | V_{DD} | 0 | 0 | DIS |
| 1 | 1 | 0 | 0 | 1 | V_{DD} | 0 | 1 | EN |
| 1 | 1 | 0 | 1 | 0 | V_{BAT} | 1 | 0 | DIS |
| 1 | 1 | 0 | 1 | 1 | V_{BAT} | 1 | 1 | EN |
| 1 | 1 | 1 | 0 | 0 | V_{DD} | 0 | 0 | DIS |
| 1 | 1 | 1 | 0 | 1 | V_{DD} | 0 | 1 | EN |
| 1 | 1 | 1 | 1 | 0 | V_{BAT} | 1 | 0 | DIS |
| 1 | 1 | 1 | 1 | 1 | V_{BAT} | 1 | 1 | EN |

| $V_{BAT} > V_{BOK}$ | BAT TOK |
|---------------------|---------|
| 0 | 0 |
| 1 | 1 |

CONDITION: $V_{OUT} > V_{DD(min)}$

| \overline{CEIN} | \overline{CEOUT} |
|-------------------|--------------------|
| 0 | 0 |
| 1 | 1 |

CONDITION: Enabled

| $PFI > V_{PFI}$ | \overline{PFO} |
|-----------------|------------------|
| 0 | 0 |
| 1 | 1 |

CONDITION: $V_{OUT} > V_{DD(min)}$



TPS3600D20, TPS3600D25, TPS3600D33, TPS3600D50 BATTERY-BACKUP SUPERVISORS FOR LOW-POWER PROCESSORS

SLVS336A – DECEMBER 2000 – REVISED APRIL 2001

functional schematic

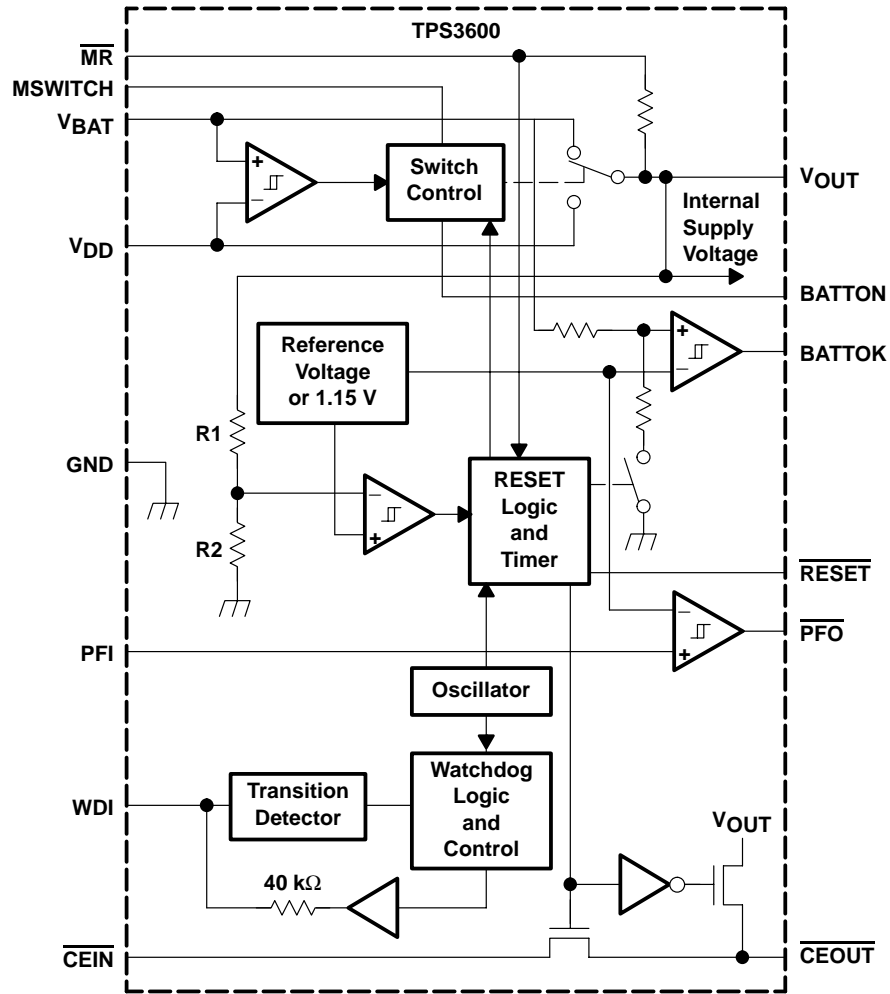

TPS3600D20, TPS3600D25, TPS3600D33, TPS3600D50 BATTERY-BACKUP SUPERVISORS FOR LOW-POWER PROCESSORS

SLVS336A – DECEMBER 2000 – REVISED APRIL 2001

timing diagram

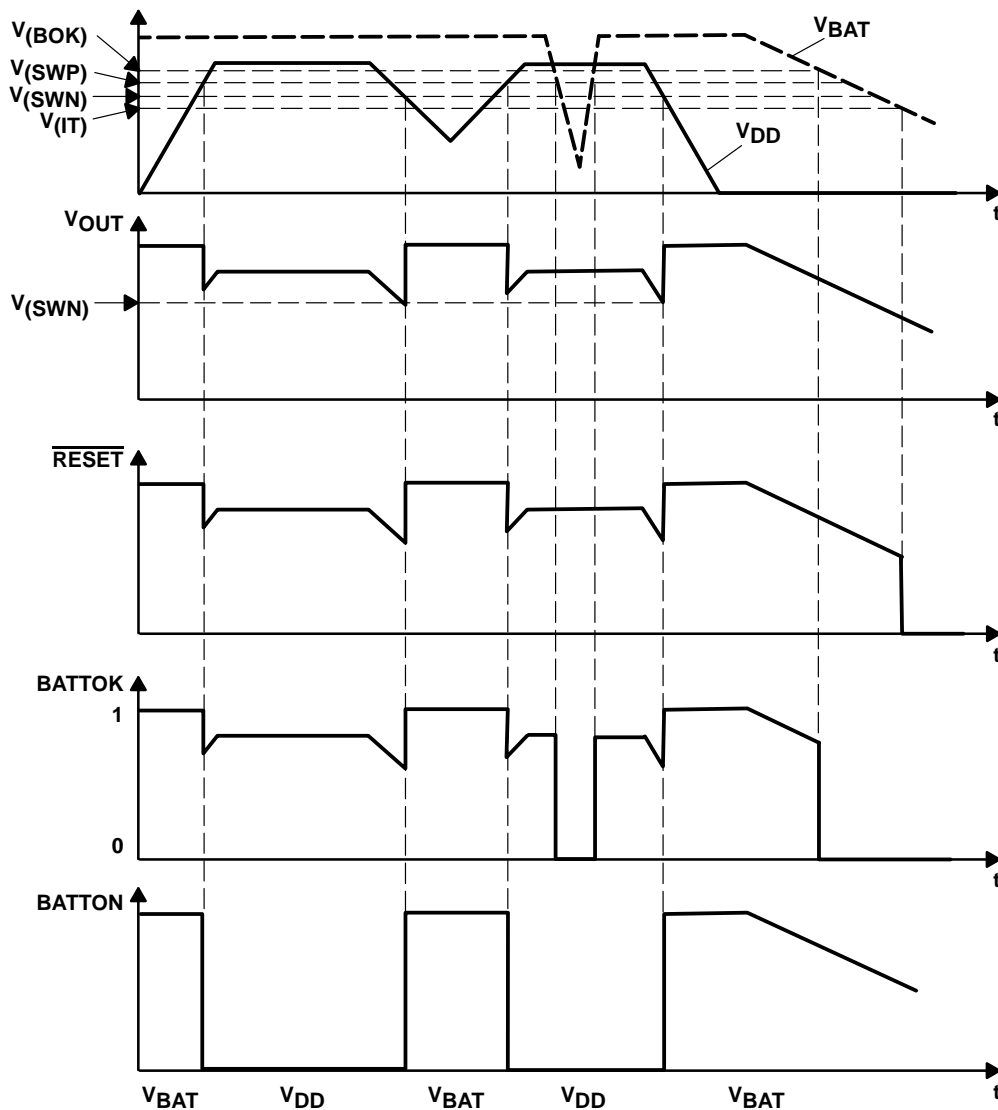

NOTES: A. MSWITCH = 0, \overline{MR} = 1

NOTES: B. Timing diagram shown under normal operation, not in freshness seal mode.

TPS3600D20, TPS3600D25, TPS3600D33, TPS3600D50 BATTERY-BACKUP SUPERVISORS FOR LOW-POWER PROCESSORS

SLVS336A – DECEMBER 2000 – REVISED APRIL 2001

Terminal Functions

| TERMINAL NAME | NO. | I/O | DESCRIPTION |
|---------------------------|-----|-----|---|
| BATTOK | 9 | O | Battery status output |
| BATTON | 6 | O | Logic output/external bypass switch driver output |
| $\overline{\text{CEIN}}$ | 5 | I | Chip-enable input |
| $\overline{\text{CEOUT}}$ | 10 | O | Chip-enable output |
| GND | 3 | I | Ground |
| $\overline{\text{MR}}$ | 11 | I | Manual reset input |
| MSWITCH | 4 | I | Manual switch to force device into battery-backup mode (connect to GND if not used) |
| PFI | 7 | I | Power-fail comparator input (connect to GND if not used) |
| $\overline{\text{PFO}}$ | 8 | O | Power-fail comparator output |
| $\overline{\text{RESET}}$ | 13 | O | Active-low reset output |
| V _{BAT} | 14 | I | Backup-battery input |
| V _{DD} | 2 | I | Input supply voltage |
| V _{OUT} | 1 | O | Supply output |
| WDI | 12 | I | Watchdog timer input |

detailed description

battery freshness seal

The battery freshness seal of the TPS3600 family disconnects the backup battery from the internal circuitry until it is needed. This ensures that the backup battery connected to V_{BAT} should be fresh when the final product is put to use. The following steps explain how to enable the freshness seal mode:

1. Connect V_{BAT} (V_{BAT} > V_{BAT(min)})
2. Ground $\overline{\text{PFO}}$
3. Connect PFI to V_{DD} or PFI > V_(PFI)
4. Connect V_{DD} to power supply (V_{DD} > V_{IT})
5. Ground $\overline{\text{MR}}$
6. Power down V_{DD}
7. The freshness seal mode is entered and pins $\overline{\text{PFO}}$ and $\overline{\text{MR}}$ can be disconnected.

The battery freshness seal mode is disabled by the positive-going edge of $\overline{\text{RESET}}$ when V_{DD} is applied.

BATTOK output

This is a logic feedback of the device to indicate the status of the backup battery. The supervisor checks the battery voltage every 200 ms with a voltage divider load of approximately 100 K Ω and a measure cycle on-time of 25 μs . This measurement cycle starts after the reset is released. If the battery voltage V_{BAT} is below the negative-going threshold voltage V_(BOK), the indicator BATTOK does a high-to-low transition. Otherwise, its status remains to the V_{OUT} level.

Table 1. Typical Values for BATTOK Indication

| SUPERVISOR TYPE | V _{IT} TYP | V _{BOK} MIN | V _{BOK} TYP | V _{BOK} MAX |
|-----------------|---------------------|----------------------|----------------------|----------------------|
| TPS3600D20 | 1.78 V | 1.84 V | 1.91 V | 1.97 V |
| TPS3600D25 | 2.22 V | 2.3 V | 2.38 V | 2.46 V |
| TPS3600D33 | 2.93 V | 3.04 V | 3.14 V | 3.24 V |
| TPS3600D50 | 4.40 V | 4.56 V | 4.71 V | 4.86 V |



detailed description (continued)

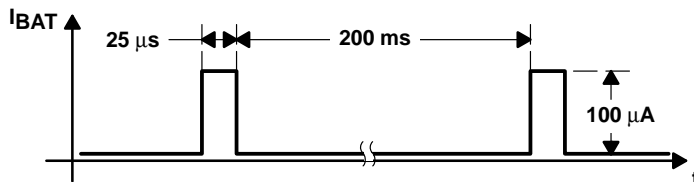

Figure 1. BATTOK Timing

chip-enable signal gating

The internal gating of chip-enable signals (CE) prevents erroneous data from corrupting CMOS RAM during an under-voltage condition. The TPS3600 use a series transmission gate from \overline{CEIN} to \overline{CEOUT} . During normal operation (reset not asserted), the CE transmission gate is enabled and passes all CE transitions. When reset is asserted, this path becomes disabled, preventing erroneous data from corrupting the CMOS RAM. The short CE propagation delay from \overline{CEIN} to \overline{CEOUT} enables the TPS3600 devices to be used with most processors.

The CE transmission gate is disabled and \overline{CEIN} is high impedance (disable mode) while reset is asserted. During a power-down sequence when V_{DD} crosses the reset threshold, the CE transmission gate will be disabled and \overline{CEIN} immediately becomes high impedance if the voltage at \overline{CEIN} is high. If \overline{CEIN} is low during reset is asserted, the CE transmission gate will be disabled same time when \overline{CEIN} goes high, or 15 μ s after reset asserts, whichever occurs first. This will allow the current write cycle to complete during power down. When the CE transmission gate is enabled, the impedance of \overline{CEIN} appears as a resistor in series with the load at \overline{CEOUT} . The overall device propagation delay through the CE transmission gate depends on V_{OUT} , the source impedance of the device connected to \overline{CEIN} and the load at \overline{CEOUT} . To achieve minimum propagation delay, the capacitive load at \overline{CEOUT} should be minimized, and a low-output-impedance driver be used.

During disable mode, the transmission gate is off and an active pullup connects \overline{CEOUT} to V_{OUT} . This pullup turns off when the transmission gate is enabled.

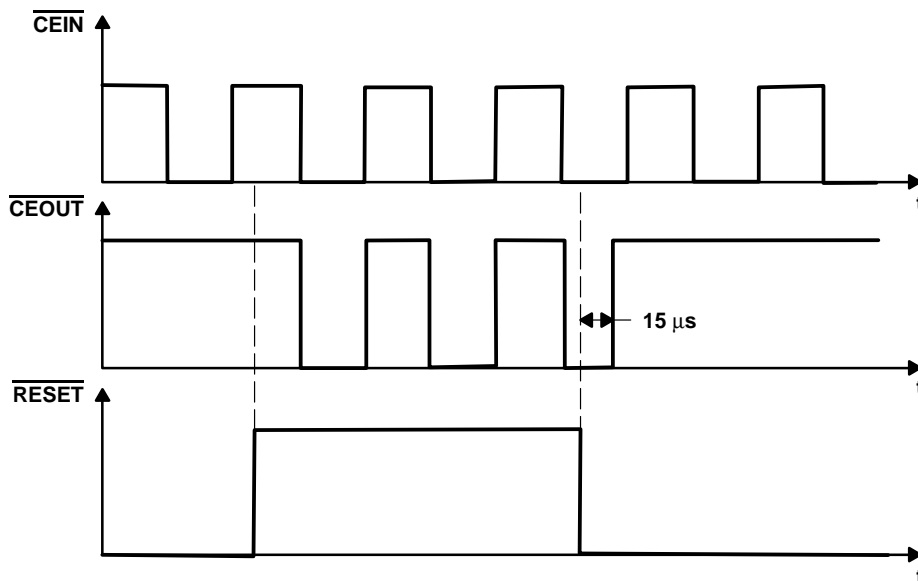

Figure 2. Chip-Enable Timing

TPS3600D20, TPS3600D25, TPS3600D33, TPS3600D50 BATTERY-BACKUP SUPERVISORS FOR LOW-POWER PROCESSORS

SLVS336A – DECEMBER 2000 – REVISED APRIL 2001

detailed description (continued)

power-fail comparator (PFI and $\overline{\text{PFO}}$)

An additional comparator is provided to monitor voltages other than the nominal supply voltage. The power-fail input (PFI) will be compared with an internal voltage reference of 1.15 V. If the input voltage falls below the power-fail threshold, $V_{(\text{PFI})}$, of 1.15 V typical, the power-fail output ($\overline{\text{PFO}}$) goes low. If it goes above $V_{(\text{PFI})}$ plus about 12-mV hysteresis, the output returns to high. By connecting two external resistors, it is possible to supervise any voltages above $V_{(\text{PFI})}$. The sum of both resistors should be about 1 M Ω , to minimize power consumption and also to ensure that the current in the PFI pin can be neglected compared with the current through the resistor network. The tolerance of the external resistors should be not more than 1% to ensure minimal variation of sensed voltage.

If the power-fail comparator is unused, connect PFI to ground and leave $\overline{\text{PFO}}$ unconnected.

BATTON

Most often BATTON is used as a gate drive for an external pass transistor for high-current applications. In addition it can be also used as a logic output to indicate the battery switchover status. BATTON is high when V_{OUT} is connected to V_{BAT} .

BATTON can be directly connected to the gate of a PMOS transistor (see Figure 3). No current-limiting resistor is required. When using a PMOS transistor, it must be connected backwards from the traditional method (see Figure 3). This method orients the body diode from V_{DD} to V_{OUT} and prevents the backup battery from discharging through the FET when its gate is high.

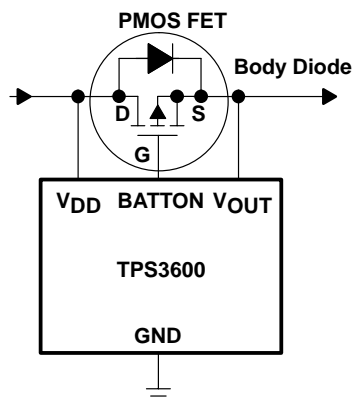

Figure 3. Driving an External MOSFET Transistor With BATTON

backup-battery switchover

In the event of a brownout or power failure, it may be necessary to keep a processor running. If a backup battery is installed at V_{BAT} , the devices automatically connect the processor to backup power when V_{DD} fails. In order to allow the backup battery (e.g., a 3.6-V lithium cell) to have a higher voltage than V_{DD} , this family of supervisors will not connect V_{BAT} to V_{OUT} when V_{BAT} is greater than V_{DD} . V_{BAT} only connects to V_{OUT} (through a 2- Ω switch) when V_{OUT} falls below $V_{(\text{SWN})}$ and V_{BAT} is greater than V_{DD} . When V_{DD} recovers, switchover is deferred either until V_{DD} crosses V_{BAT} , or when V_{DD} rises above the threshold $V_{(\text{SWP})}$. (See the timing diagram)

| $V_{\text{DD}} > V_{\text{BAT}}$ | $V_{\text{DD}} > V_{(\text{SW})}$ | V_{OUT} |
|----------------------------------|-----------------------------------|------------------|
| 1 | 1 | V_{DD} |
| 1 | 0 | V_{DD} |
| 0 | 1 | V_{DD} |
| 0 | 0 | V_{BAT} |

detailed description (continued)

manual switchover (MSWITCH)

While operating in the normal mode from V_{DD} , the device can be manually forced to operate in the battery-backup mode by connecting MSWITCH to V_{DD} . The table below shows the different switchover modes.

| | MSWITCH | STATUS |
|---------------------------------|----------|-------------------------------|
| V_{DD} mode | GND | V_{DD} mode |
| | V_{DD} | Switch to battery-backup mode |
| Battery-backup mode | GND | Battery-backup mode |
| | V_{DD} | Battery-backup mode |

If the manual switchover feature is not used, MSWITCH must be connected to ground.

watchdog

In a microprocessor- or DSP-based system, it is not only important to supervise the supply voltage, it is also important to ensure the correct program execution. The task of a watchdog is to ensure that the program is not stalled in an indefinite loop. The microprocessor, microcontroller, or the DSP have to toggle the watchdog input within typically 0.8 s to avoid a time-out from occurring. Either a low-to-high or a high-to-low transition resets the internal watchdog timer. If the input is unconnected the watchdog is disabled and will be retriggered internally.

saving current while using the watchdog

The watchdog input is internally driven low during the first 7/8 of the watchdog time-out period, then momentarily pulses high, resetting the watchdog counter. For minimum watchdog input current (minimum overall power consumption), leave WDI low for the majority of the watchdog time-out period, pulsing it low-high-low once within 7/8 of the watchdog time-out period to reset the watchdog timer. If instead, WDI is externally driven high for the majority of the time-out period, a current of e.g. $5\text{ V}/40\text{ k}\Omega \approx 125\text{ }\mu\text{A}$ can flow into WDI.

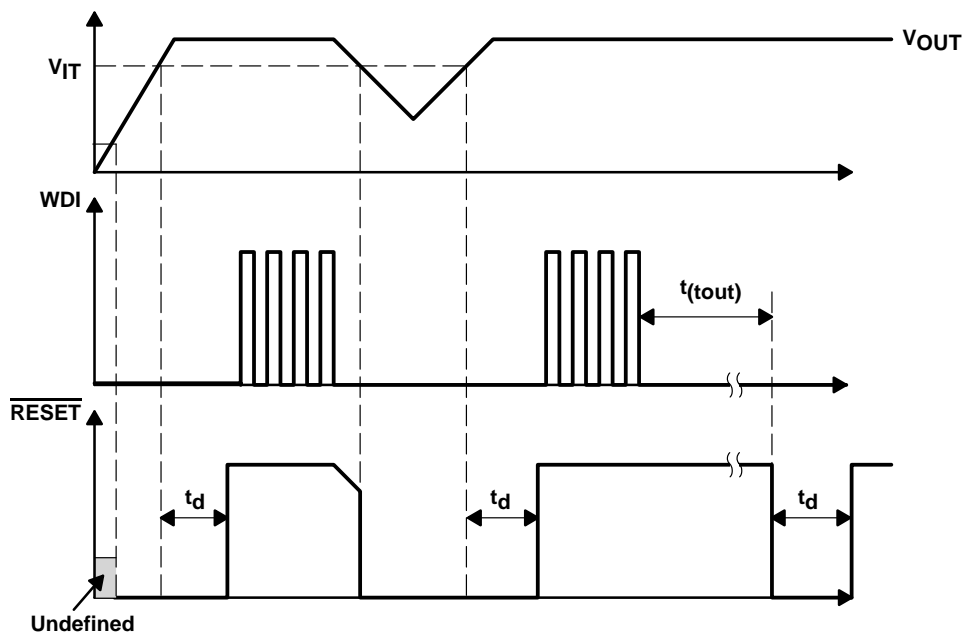

Figure 4. Watchdog Timing

TPS3600D20, TPS3600D25, TPS3600D33, TPS3600D50 BATTERY-BACKUP SUPERVISORS FOR LOW-POWER PROCESSORS

SLVS336A – DECEMBER 2000 – REVISED APRIL 2001

absolute maximum ratings over operating free-air temperature (unless otherwise noted)†

| | |
|--|------------------------------|
| Supply voltage: V_{DD} (see Note1) | 7 V |
| All other pins (see Note 1) | -0.3 V to 7 V |
| Continuous output current at V_{OUT} : I_O | 300 mA |
| All other pins, I_O | ±10 mA |
| Continuous total power dissipation | See Dissipation Rating Table |
| Operating free-air temperature range, T_A | -40°C to 85°C |
| Storage temperature range, T_{stg} | -65°C to 150°C |
| Lead temperature soldering 1,6 mm (1/16 inch) from case for 10 seconds | 260°C |

† Stresses beyond those listed under “absolute maximum ratings” may cause permanent damage to the device. These are stress ratings only, and functional operation of the device at these or any other conditions beyond those indicated under “recommended operating conditions” is not implied. Exposure to absolute-maximum-rated conditions for extended periods may affect device reliability.

NOTE 1: All voltage values are with respect to GND. For reliable operation the device must not be operated at 7 V for more than $t = 1000h$ continuously.

DISSIPATION RATING TABLE

| PACKAGE | $T_A < 25^\circ\text{C}$ POWER RATING | DERATING FACTOR ABOVE $T_A = 25^\circ\text{C}$ | $T_A = 70^\circ\text{C}$ POWER RATING | $T_A = 85^\circ\text{C}$ POWER RATING |
|---------|--|---|--|--|
| PW | 700 mW | 5.6 mW/°C | 448 mW | 364 mW |

recommended operating conditions at specified temperature range

| | MIN | MAX | UNIT |
|--|----------------------|-----------------|-------|
| Supply voltage, V_{DD} | 1.65 | 5.5 | V |
| Battery supply voltage, V_{BAT} | 1.5 | 5.5 | V |
| Input voltage, V_I | 0 | $V_{OUT} + 0.3$ | V |
| High-level input voltage, V_{IH} | $0.7 \times V_{OUT}$ | | V |
| Low-level input voltage, all other pins, V_{IL} | $0.3 \times V_{OUT}$ | | V |
| Continuous output current at V_{OUT} : I_O | 200 | | mA |
| Input transition rise and fall rate at WDI, MSWITCH, $\Delta t/\Delta V$ | 100 | | ns/V |
| Slew rate at V_{DD} or V_{BAT} | 34 | | mV/μs |
| Operating free-air temperature range, T_A | -40 | 85 | °C |



TPS3600D20, TPS3600D25, TPS3600D33, TPS3600D50 BATTERY-BACKUP SUPERVISORS FOR LOW-POWER PROCESSORS

SLVS336A – DECEMBER 2000 – REVISED APRIL 2001

electrical characteristics over recommended operating conditions (unless otherwise noted)

| PARAMETER | | TEST CONDITIONS | MIN | TYP | MAX | UNIT | |
|---------------------|--|--|---|--------------------------|------------------------|------|---|
| V _{OH} | High-level output voltage | RESET, BATTOK, BATTON | V _{OUT} = 2.0 V, I _{OH} = -400 μA | V _{OUT} - 0.2 V | | V | |
| | | | V _{OUT} = 3.3 V, I _{OH} = -2 mA | V _{OUT} - 0.4 V | | | |
| | | | V _{OUT} = 5.0 V, I _{OH} = -3 mA | V _{OUT} - 0.4 V | | | |
| | PFO | | V _{OUT} = 1.8 V, I _{OH} = -20 μA | V _{OUT} - 0.3 V | | | |
| | | | V _{OUT} = 3.3 V, I _{OH} = -80 μA | V _{OUT} - 0.4 V | | | |
| | | | V _{OUT} = 5.0 V, I _{OH} = -120 μA | V _{OUT} - 0.4 V | | | |
| | CEOUT Enable mode CEIN = V _{OUT} | | V _{OUT} = 2.0 V, I _{OH} = -1 mA | V _{OUT} - 0.2 V | | | |
| | | | V _{OUT} = 3.3 V, I _{OH} = -2 mA | V _{OUT} - 0.3 V | | | |
| | | | V _{OUT} = 5.0 V, I _{OH} = -5 mA | V _{OUT} - 0.3 V | | | |
| | CEOUT Disable mode | | V _{OUT} = 3.3 V, I _{OH} = -0.5 mA | V _{OUT} - 0.4 V | | | |
| V _{OL} | Low-level output voltage | RESET, PFO, BATTOK | V _{OUT} = 2.0 V, I _{OL} = 400 μA | 0.2 | | V | |
| | | | V _{OUT} = 3.3 V, I _{OL} = 2 mA | 0.4 | | | |
| | | | V _{OUT} = 5.0 V, I _{OL} = 3 mA | 0.4 | | | |
| | BATTON | | V _{OUT} = 1.8 V, I _{OL} = 500 μA | 0.2 | | | |
| | | | V _{OUT} = 3.3 V, I _{OL} = 3 mA | 0.4 | | | |
| | | | V _{OUT} = 5.0 V, I _{OL} = 5 mA | 0.4 | | | |
| | CEOUT Enable mode CEIN = 0 V | | V _{OUT} = 2.0 V, I _{OL} = 1 mA | 0.2 | | | |
| | | | V _{OUT} = 3.3 V, I _{OL} = 2 mA | 0.3 | | | |
| | | | V _{OUT} = 5.0 V, I _{OL} = 5 mA | 0.3 | | | |
| | V _{res} | Power-up reset voltage (see Note 2) | V _{BAT} > 1.1 V OR V _{DD} > 1.4 V, I _{OL} = 20 μA | 0.4 | | | V |
| V _{OUT} | Normal mode | I _O = 5 mA, V _{DD} = 1.8 V | V _{DD} - 50 mV | | V | | |
| | | I _O = 75 mA, V _{DD} = 3.3 V | V _{DD} - 150 mV | | | | |
| | | I _O = 150 mA, V _{DD} = 5 V | V _{DD} - 250 mV | | | | |
| | Battery-backup mode | I _O = 4 mA, V _{BAT} = 1.5 V | V _{BAT} - 50 mV | | | | |
| | | I _O = 75 mA, V _{BAT} = 3.3 V | V _{BAT} - 150 mV | | | | |
| r _{ds(on)} | V _{DD} to V _{OUT} on-resistance | V _{DD} = 3.3 V | 1 | 2 | Ω | | |
| | V _{BAT} to V _{OUT} on-resistance | V _{BAT} = 3.3 V | 1 | 2 | | | |
| V _{IT} | Negative-going input threshold voltage (see Notes 3 and 4) | TPS3600x20 | T _A = -40°C to 85°C | 1.74 | 1.78 | 1.82 | V |
| | | TPS3600x25 | | 2.17 | 2.22 | 2.27 | |
| | | TPS3600x30 | | 2.57 | 2.63 | 2.69 | |
| | | TPS3600x33 | | 2.87 | 2.93 | 2.99 | |
| | | TPS3600x50 | | 4.31 | 4.40 | 4.49 | |
| | | PFI | | 1.13 | 1.15 | 1.17 | |
| V(PFI) | | | V _{IT} + 5.8% | V _{IT} + 7.1% | V _{IT} + 8.3% | V | |
| V(BOK) | TPS3600Dxx | | | | | | |
| V(SWN) | Battery switch threshold voltage negative-going V _{OUT} | | V _{IT} + 1% | V _{IT} + 2% | V _{IT} + 3.2% | V | |

- NOTES: 2. The lowest supply voltage at which RESET becomes active. t_r(V_{DD}) ≥ 15 μs/V.
3. To ensure best stability of the threshold voltage, a bypass capacitor (ceramic, 0.1 μF) should be placed near the supply terminal.
4. Voltage is sensed at V_{OUT}



TPS3600D20, TPS3600D25, TPS3600D33, TPS3600D50 BATTERY-BACKUP SUPERVISORS FOR LOW-POWER PROCESSORS

SLVS336A – DECEMBER 2000 – REVISED APRIL 2001

electrical characteristics over recommended operating conditions (unless otherwise noted) (continued)

| PARAMETER | | TEST CONDITIONS | MIN | TYP | MAX | UNIT |
|------------------------------------|---------------------------------|-------------------------------------|--|-----|-----------|------|
| V _{hys} | Hysteresis | V _{IT} | 1.65 V < V _{IT} < 2.5 V | | 20 | mV |
| | | | 2.5 V < V _{IT} < 3.5 V | | 40 | |
| | | | 3.5 V < V _{IT} < 5.5 V | | 50 | |
| | BATTOK | 1.65 V < V _(BOK) < 2.5 V | | 30 | | |
| | | 2.5 V < V _(BOK) < 3.5 V | | 60 | | |
| | | 3.5 V < V _(BOK) < 5.5 V | | 100 | | |
| | PFI | | | 12 | | |
| | V _(BSW) | V _{DD} = 1.8 V | | 66 | | |
| | V _(SWN) | 1.65 V < V _(SWN) < 2.5 V | | 85 | | |
| 2.5 V < V _(SWN) < 3.5 V | | 100 | | | | |
| 3.5 V < V _(SWN) < 5.5 V | | 110 | | | | |
| I _{IH} | High-level input current | WDI (see Note 5) | WDI = V _{DD} = 5 V | | 150 | μA |
| | | MR | MR = 0.7 × V _{DD} , V _{DD} = 5 V | | -33 -76 | |
| I _{IL} | Low-level input current | WDI (see Note 5) | WDI = 0 V, V _{DD} = 5 V | | -150 | μA |
| | | MR | MR = 0 V, V _{DD} = 5 V | | -110 -255 | |
| I _I | Input current | PFI, MSWITCH | V _I < V _{DD} | | -25 25 | nA |
| I _{OS} | Short-circuit current | PFO | PFO = 0 V, V _{DD} = 1.8 V | | -0.3 | mA |
| | | | PFO = 0 V, V _{DD} = 3.3 V | | -1.1 | |
| | | | PFO = 0 V, V _{DD} = 5 V | | -2.4 | |
| I _{DD} | V _{DD} supply current | | V _{OUT} = V _{DD} | | 40 | μA |
| | | | V _{OUT} = V _{BAT} | | 8 | |
| I _(BAT) | V _{BAT} supply current | | V _{OUT} = V _{DD} | | -0.1 0.1 | μA |
| | | | V _{OUT} = V _{BAT} | | 40 | |
| I _{Ikg} | CEIN leakage current | | Disable mode, V _I < V _{DD} | | ±1 | μA |
| C _i | Input capacitance | | V _I = 0 V to 5.0 V | | 5 | pF |

NOTE 5: For details on how to optimize current consumption when using WDI, see the detailed description section.



TPS3600D20, TPS3600D25, TPS3600D33, TPS3600D50 BATTERY-BACKUP SUPERVISORS FOR LOW-POWER PROCESSORS

SLVS336A – DECEMBER 2000 – REVISED APRIL 2001

timing requirements at $R_L = 1\text{ M}\Omega$, $C_L = 50\text{ pF}$, $T_A = -40^\circ\text{C}$ to 85°C

| PARAMETER | | TEST CONDITIONS | MIN | TYP | MAX | UNIT | |
|-----------|-------------|-------------------------|--|-----|-----|------|---------------|
| t_w | Pulse width | V_{DD} | $V_{IH} = V_{IT} + 0.2\text{ V}$, $V_{IL} = V_{IT} - 0.2\text{ V}$ | | 5 | 1 | μs |
| | | $\overline{\text{MR}}$ | $V_{DD} > V_{IT} + 0.2\text{ V}$, $V_{IL} = 0.3 \times V_{DD}$, $V_{IH} = 0.7 \times V_{DD}$ | | 100 | | ns |
| | | $\overline{\text{WDI}}$ | | | | | |

switching characteristics at $R_L = 1\text{ M}\Omega$, $C_L = 50\text{ pF}$, $T_A = -40^\circ\text{C}$ to 85°C

| PARAMETER | | TEST CONDITIONS | MIN | TYP | MAX | UNIT | |
|---------------------|---|--|--|-----|------|---------------|---------------|
| t_d | Delay time | $V_{DD} \geq V_{IT} + 0.2\text{ V}$, $\overline{\text{MR}} \geq 0.7 \times V_{DD}$, See timing diagram | 60 | 100 | 140 | ms | |
| $t_{(\text{tout})}$ | Watchdog time-out | $V_{DD} > V_{IT} + 0.2\text{ V}$, See timing diagram | 0.48 | 0.8 | 1.12 | s | |
| t_{PLH} | Propagation (delay) time, low-to-high-level output | 50% $\overline{\text{RESET}}$ to 50% $\overline{\text{CEOUT}}$ | $V_{\text{OUT}} = V_{IT}$ | | 15 | μs | |
| t_{PHL} | Propagation (delay) time, high-to-low-level output | V_{DD} to $\overline{\text{RESET}}$ | $V_{IL} = V_{IT} - 0.2\text{ V}$, $V_{IH} = V_{IT} + 0.2\text{ V}$ | | 2 | 5 | μs |
| | | PFI to $\overline{\text{PFO}}$ | $V_{IL} = V(\text{PFI}) - 0.2\text{ V}$, $V_{IH} = V(\text{PFI}) + 0.2\text{ V}$ | | 3 | 5 | μs |
| | | $\overline{\text{MR}}$ to $\overline{\text{RESET}}$ | $V_{DD} \geq V_{IT} + 0.2\text{ V}$, $V_{IL} = 0.3 \times V_{DD}$, $V_{IH} = 0.7 \times V_{DD}$ | | 0.1 | 1 | μs |
| | | 50% $\overline{\text{CEIN}}$ to 50% $\overline{\text{CEOUT}}$ CL = 50 pF only (see Note 6) | $V_{DD} = 1.8\text{ V}$ | | 5 | 15 | ns |
| | | | $V_{DD} = 3.3\text{ V}$ | | 1.6 | 5 | ns |
| | | | $V_{DD} = 5\text{ V}$ | | 1 | 3 | ns |
| Transition time | | V_{DD} to $\overline{\text{BATTON}}$ | $V_{IL} = V_{\text{BAT}} - 0.2\text{ V}$, $V_{IH} = V_{\text{BAT}} + 0.2\text{ V}$, $V(\text{BAT}) < V_{IT}$ | | 3 | μs | |

NOTE 6: Ensured by design.

TYPICAL CHARACTERISTICS

Table of Graphs

| | | | FIGURE |
|---------------------|--|--|----------------|
| $r_{\text{DS(on)}}$ | Static Drain-source on-state resistance V_{DD} to V_{OUT} | vs Output current | 5 |
| | Static Drain-source on-state resistance V_{BAT} to V_{OUT} | | 6 |
| | Static Drain-source on-state resistance | | 7 |
| I_{DD} | Supply current | vs Supply voltage | 8, 9 |
| V_{IT} | Normalized threshold voltage | vs Free-air temperature | 10 |
| V_{OH} | High-level output voltage at $\overline{\text{RESET}}$ | vs High-level output current | 11, 12 |
| | High-level output voltage at $\overline{\text{PFO}}$ | | 13, 14 |
| | High-level output voltage at $\overline{\text{CEOUT}}$ | | 15, 16, 17, 18 |
| V_{OL} | Low-level output voltage at $\overline{\text{RESET}}$ | vs Low-level output current | 19, 20 |
| | Low-level output voltage at $\overline{\text{CEOUT}}$ | | 21, 22 |
| | Low-level output voltage at $\overline{\text{BATTON}}$ | | 23, 24 |
| $t_{\text{p(min)}}$ | Minimum Pulse Duration at V_{DD} | vs Threshold voltage overdrive at V_{DD} | 25 |
| | Minimum Pulse Duration at PFI | vs Threshold voltage overdrive at PFI | 26 |



TPS3600D20, TPS3600D25, TPS3600D33, TPS3600D50 BATTERY-BACKUP SUPERVISORS FOR LOW-POWER PROCESSORS

SLVS336A – DECEMBER 2000 – REVISED APRIL 2001

TYPICAL CHARACTERISTICS

STATIC DRAIN SOURCE ON-STATE RESISTANCE
(V_{DD} TO V_{OUT})
vs
OUTPUT CURRENT

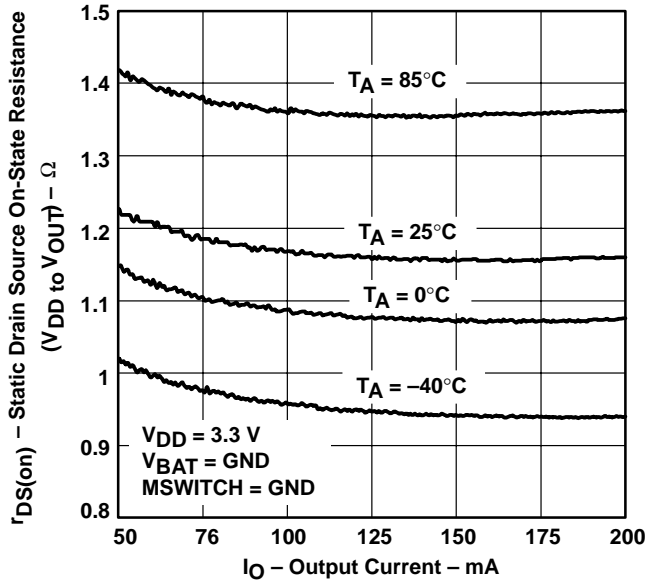

Figure 5

STATIC DRAIN SOURCE ON-STATE RESISTANCE
(V_{BAT} TO V_{OUT})
vs
OUTPUT CURRENT

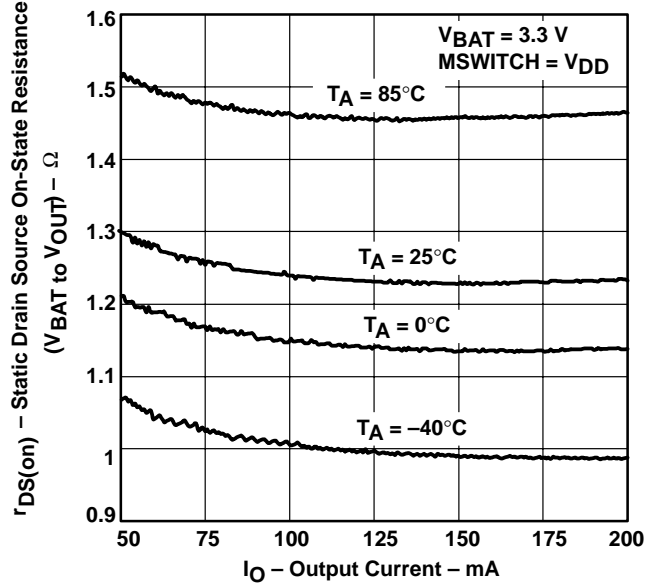

Figure 6

STATIC DRAIN SOURCE ON-STATE RESISTANCE
(CE_{IN} TO CE_{OUT})
vs
CHIP-ENABLE INPUT VOLTAGE

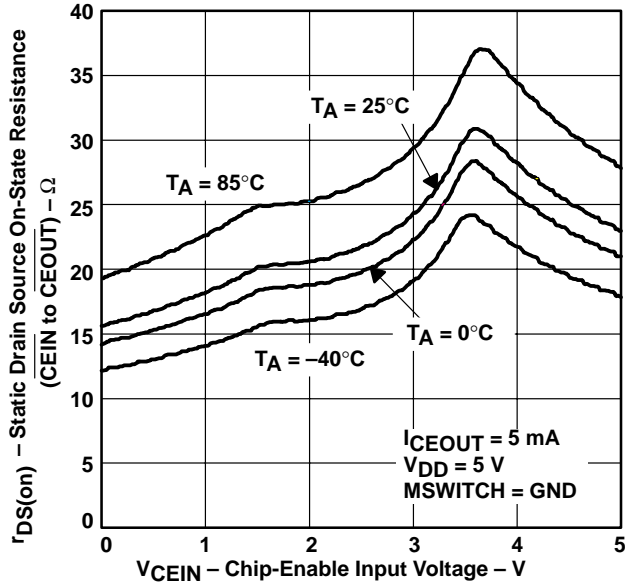

Figure 7

SUPPLY CURRENT
vs
SUPPLY VOLTAGE

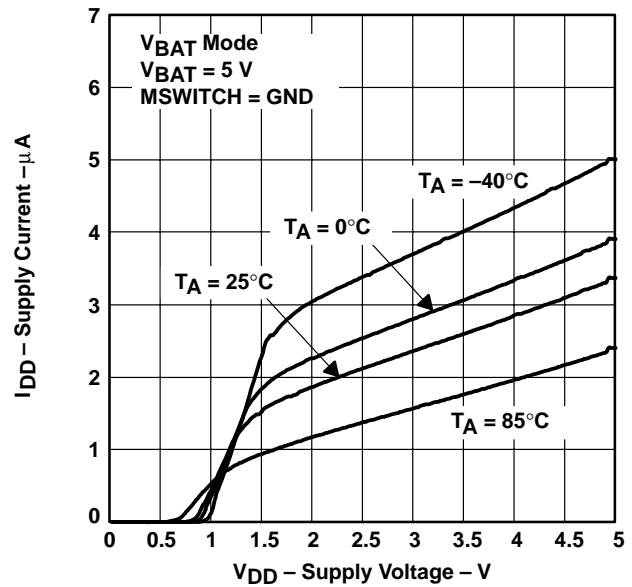

Figure 8



TYPICAL CHARACTERISTICS

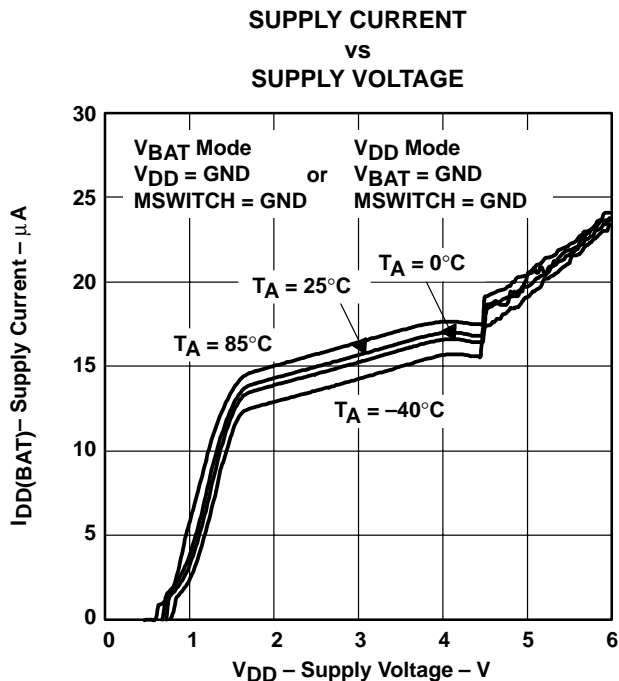

Figure 9

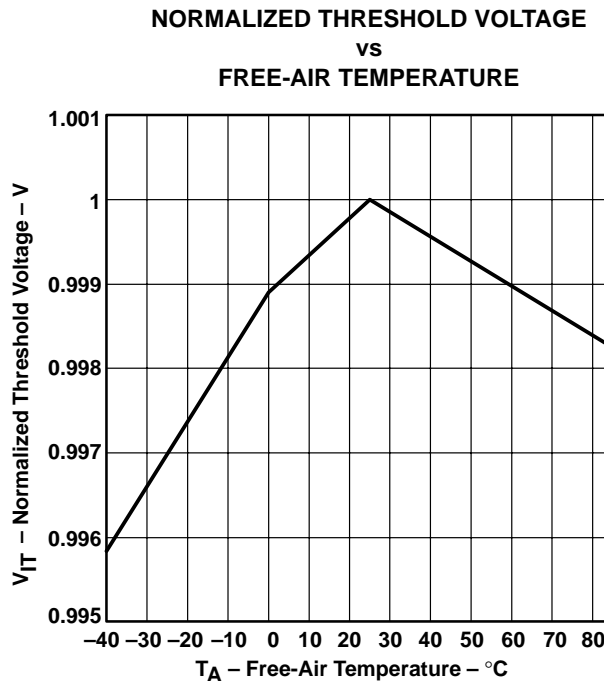

Figure 10

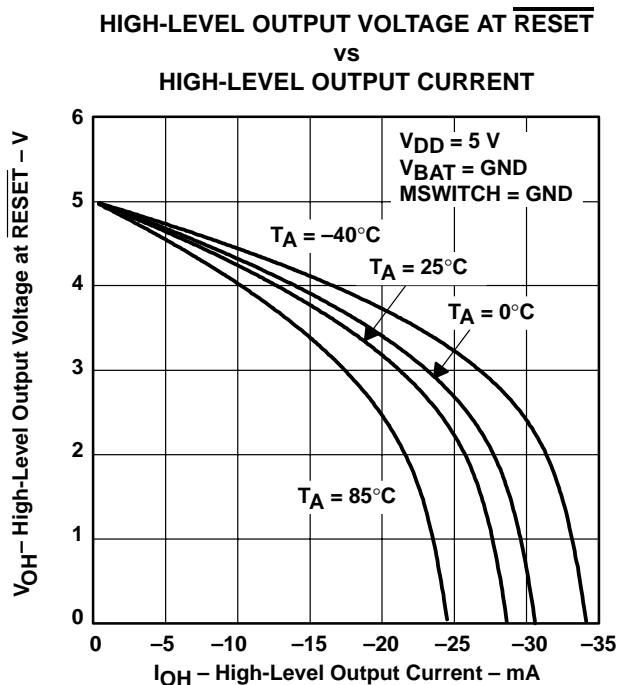

Figure 11

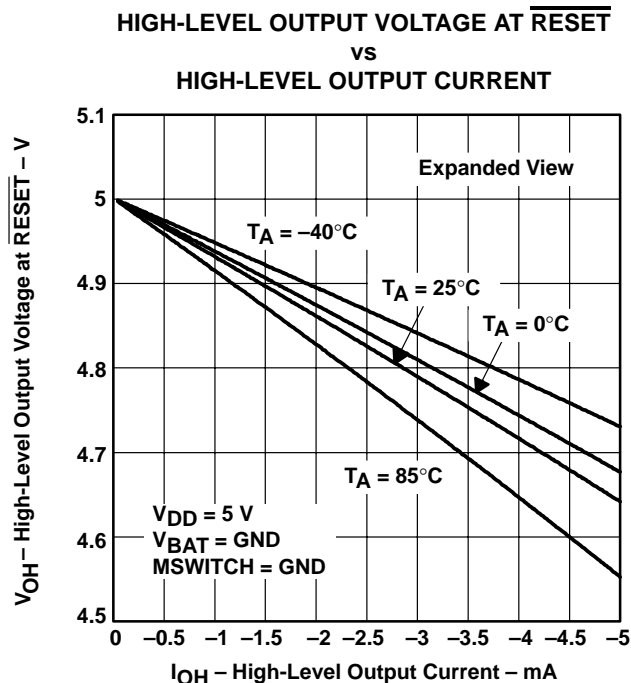
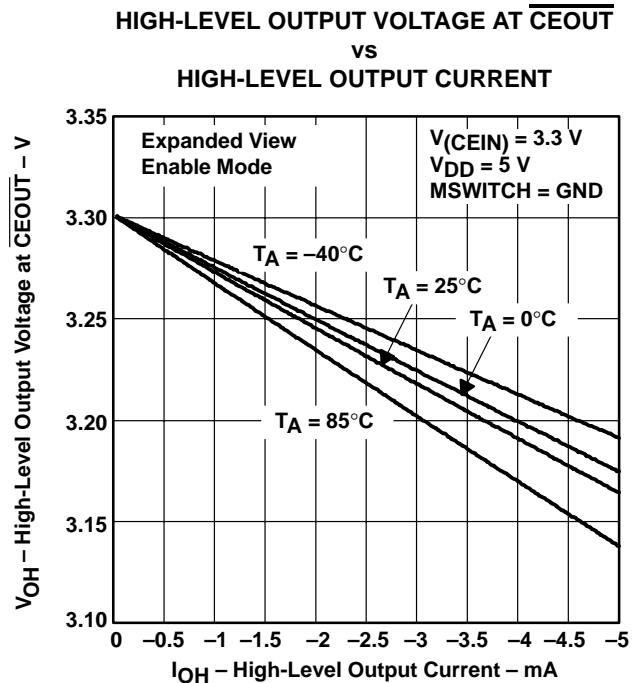
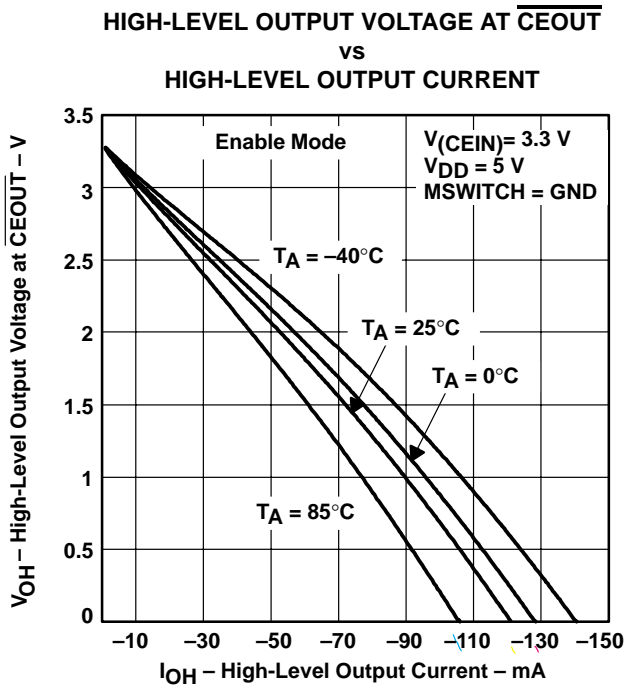
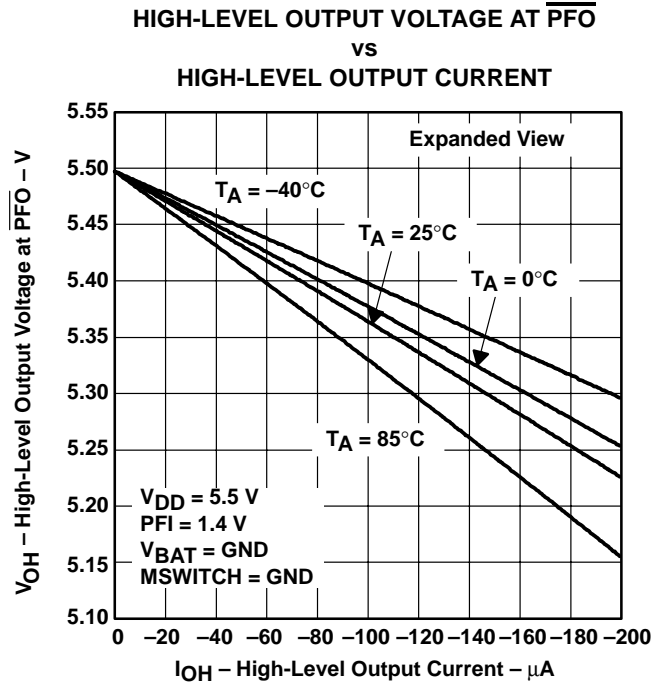
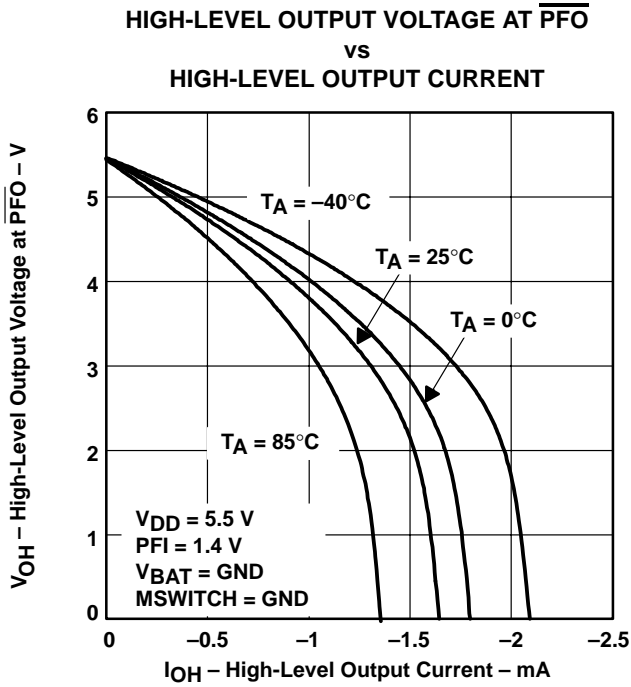

Figure 12

TPS3600D20, TPS3600D25, TPS3600D33, TPS3600D50 BATTERY-BACKUP SUPERVISORS FOR LOW-POWER PROCESSORS

SLVS336A – DECEMBER 2000 – REVISED APRIL 2001

TYPICAL CHARACTERISTICS



TYPICAL CHARACTERISTICS

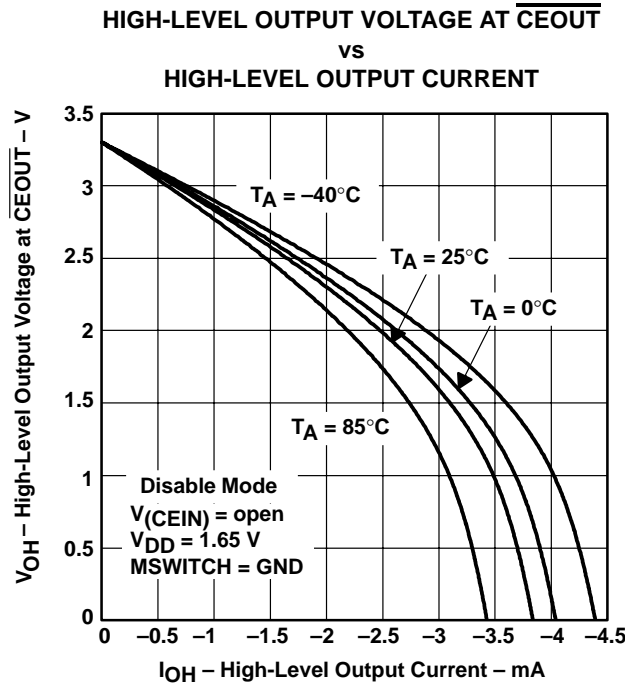

Figure 17

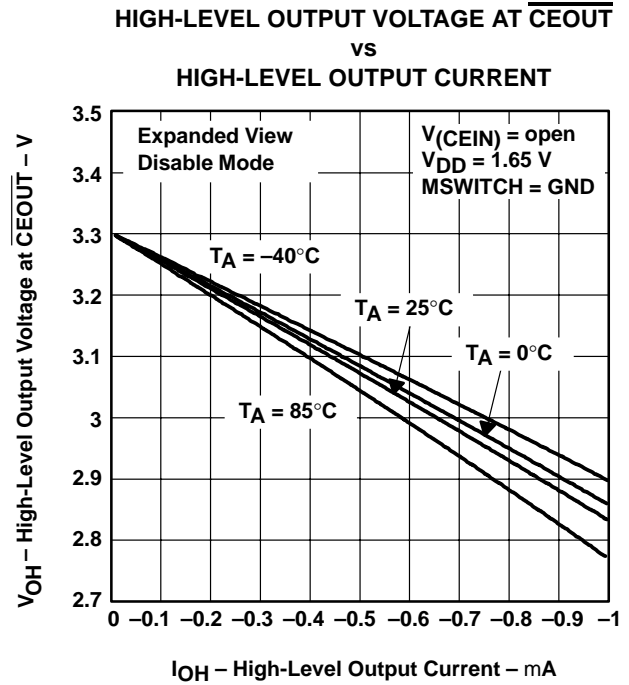

Figure 18

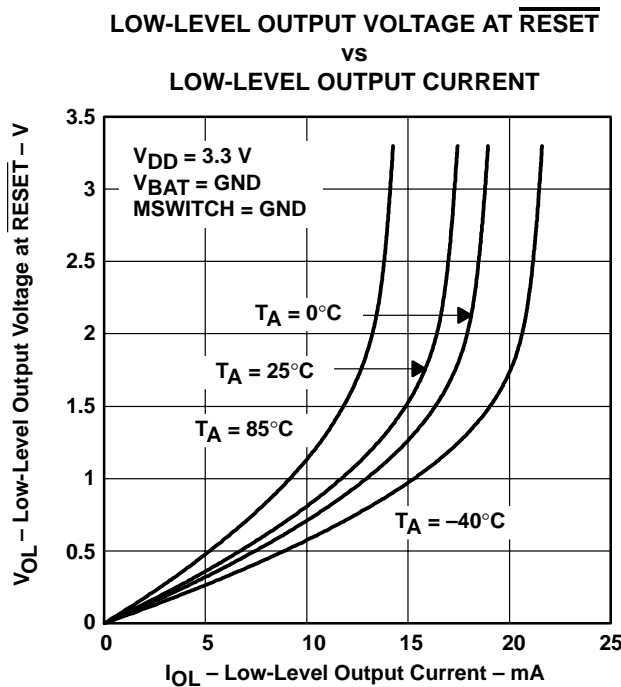

Figure 19

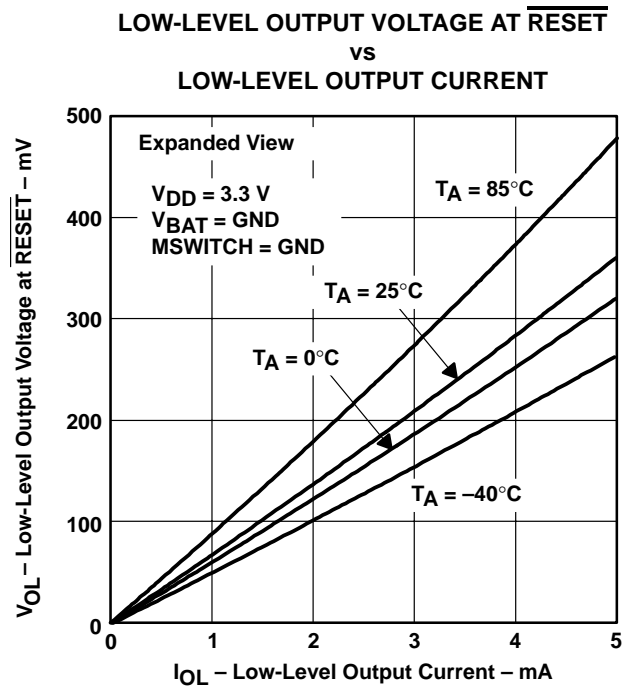

Figure 20

TPS3600D20, TPS3600D25, TPS3600D33, TPS3600D50 BATTERY-BACKUP SUPERVISORS FOR LOW-POWER PROCESSORS

SLVS336A – DECEMBER 2000 – REVISED APRIL 2001

TYPICAL CHARACTERISTICS

LOW-LEVEL OUTPUT VOLTAGE AT $\overline{\text{CEOUT}}$
vs
LOW-LEVEL OUTPUT CURRENT

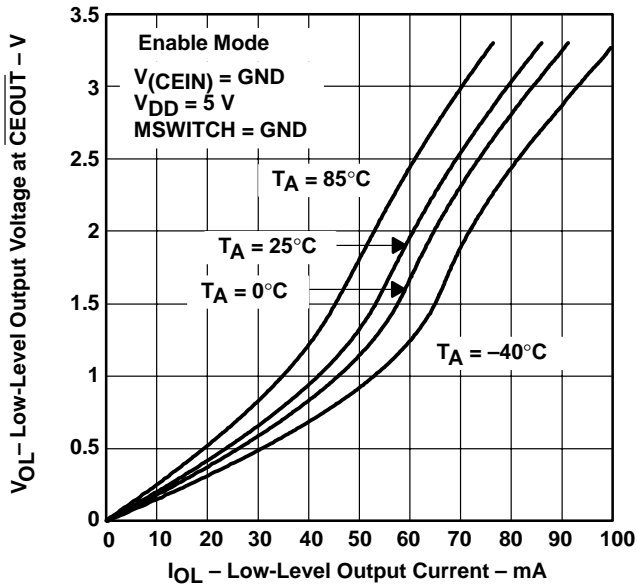

Figure 21

LOW-LEVEL OUTPUT VOLTAGE AT $\overline{\text{CEOUT}}$
vs
LOW-LEVEL OUTPUT CURRENT

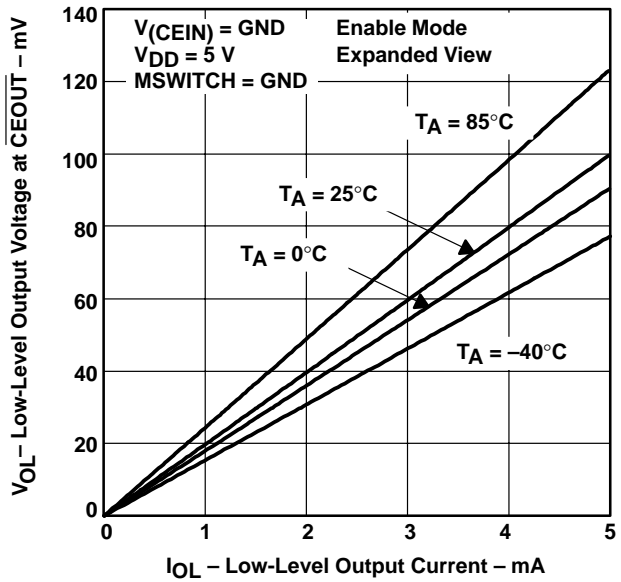

Figure 22

LOW-LEVEL OUTPUT VOLTAGE AT $\overline{\text{BATTON}}$
vs
LOW-LEVEL OUTPUT CURRENT

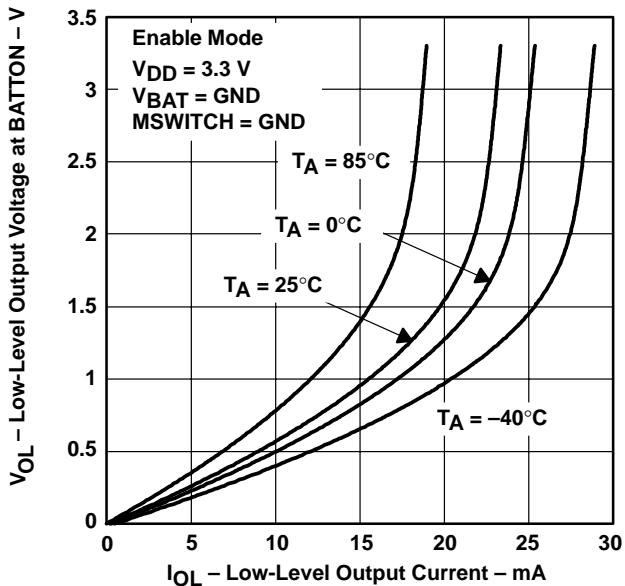

Figure 23

LOW-LEVEL OUTPUT VOLTAGE AT $\overline{\text{BATTON}}$
vs
LOW-LEVEL OUTPUT CURRENT

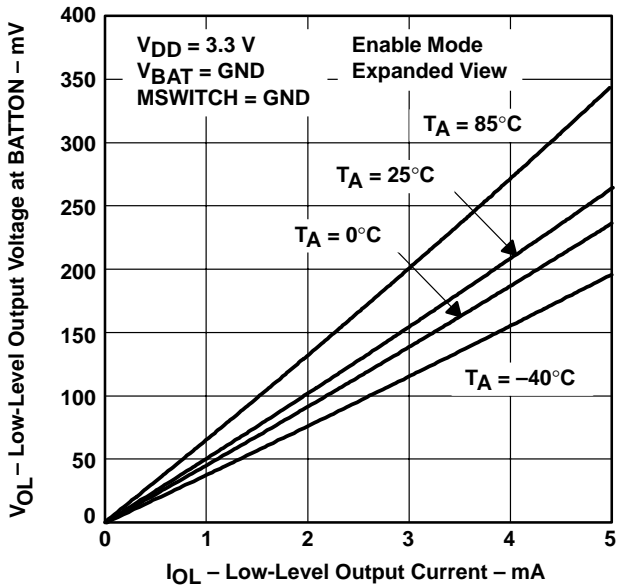

Figure 24



TYPICAL CHARACTERISTICS

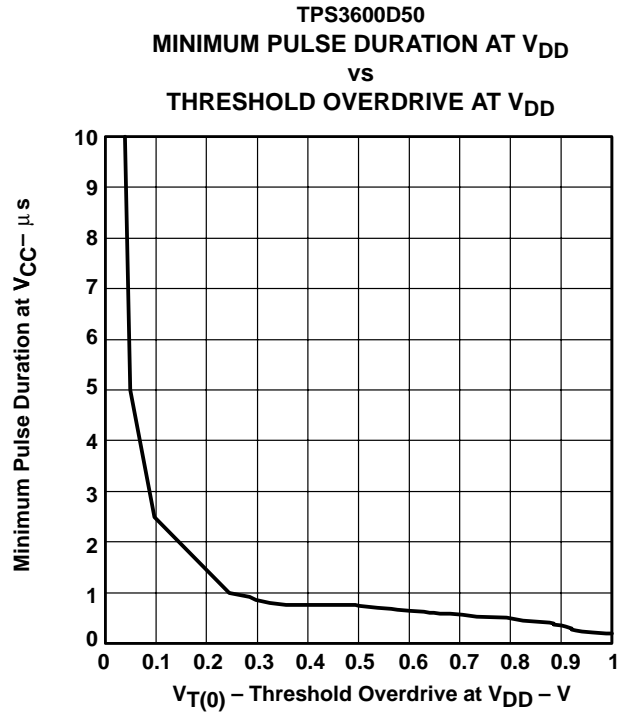

Figure 25

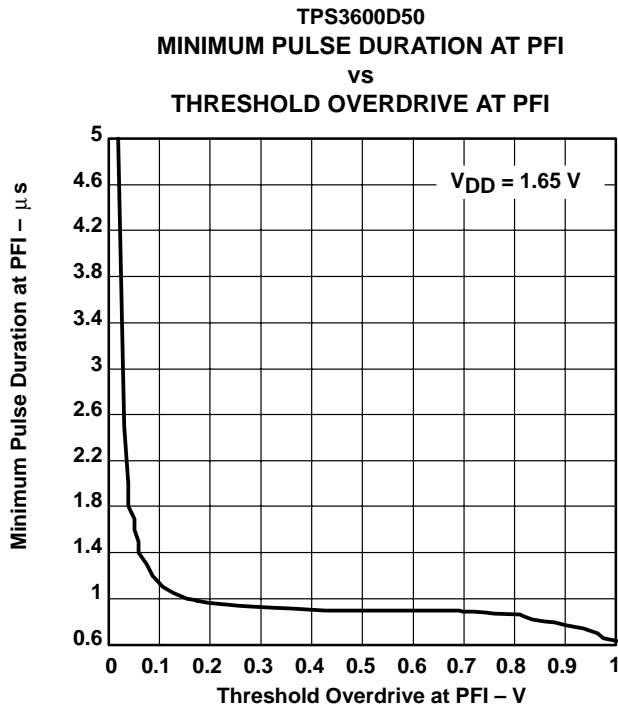

Figure 26

TPS3600D20, TPS3600D25, TPS3600D33, TPS3600D50 BATTERY-BACKUP SUPERVISORS FOR LOW-POWER PROCESSORS

SLVS336A – DECEMBER 2000 – REVISED APRIL 2001

MECHANICAL DATA

PW (R-PDSO-G**)

PLASTIC SMALL-OUTLINE PACKAGE

14 PINS SHOWN

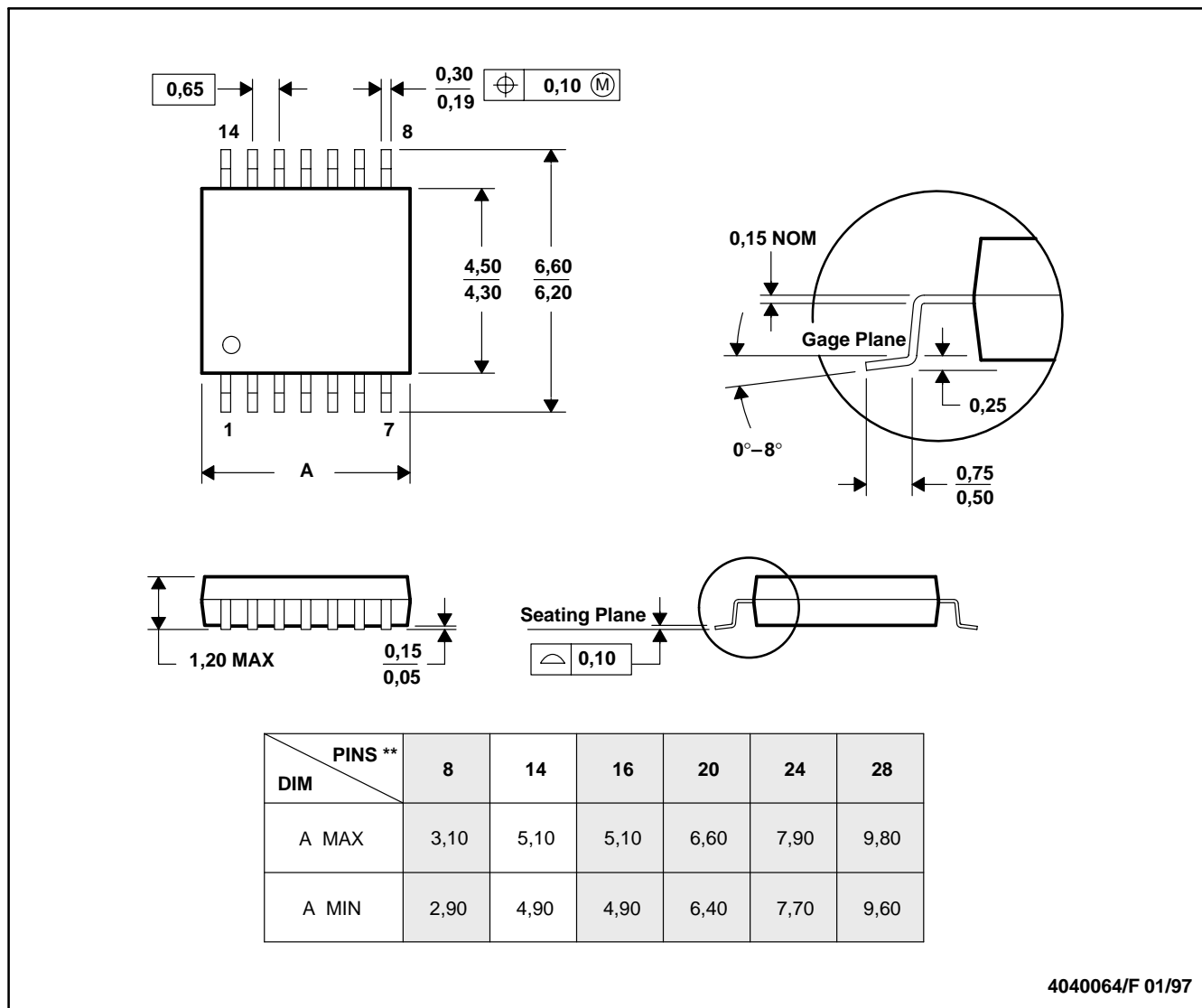

4040064/F 01/97

- NOTES: A. All linear dimensions are in millimeters.
 B. This drawing is subject to change without notice.
 C. Body dimensions do not include mold flash or protrusion not to exceed 0,15.
 D. Falls within JEDEC MO-153

IMPORTANT NOTICE

Texas Instruments and its subsidiaries (TI) reserve the right to make changes to their products or to discontinue any product or service without notice, and advise customers to obtain the latest version of relevant information to verify, before placing orders, that information being relied on is current and complete. All products are sold subject to the terms and conditions of sale supplied at the time of order acknowledgment, including those pertaining to warranty, patent infringement, and limitation of liability.

TI warrants performance of its products to the specifications applicable at the time of sale in accordance with TI's standard warranty. Testing and other quality control techniques are utilized to the extent TI deems necessary to support this warranty. Specific testing of all parameters of each device is not necessarily performed, except those mandated by government requirements.

Customers are responsible for their applications using TI components.

In order to minimize risks associated with the customer's applications, adequate design and operating safeguards must be provided by the customer to minimize inherent or procedural hazards.

TI assumes no liability for applications assistance or customer product design. TI does not warrant or represent that any license, either express or implied, is granted under any patent right, copyright, mask work right, or other intellectual property right of TI covering or relating to any combination, machine, or process in which such products or services might be or are used. TI's publication of information regarding any third party's products or services does not constitute TI's approval, license, warranty or endorsement thereof.

Reproduction of information in TI data books or data sheets is permissible only if reproduction is without alteration and is accompanied by all associated warranties, conditions, limitations and notices. Representation or reproduction of this information with alteration voids all warranties provided for an associated TI product or service, is an unfair and deceptive business practice, and TI is not responsible nor liable for any such use.

Resale of TI's products or services with statements different from or beyond the parameters stated by TI for that product or service voids all express and any implied warranties for the associated TI product or service, is an unfair and deceptive business practice, and TI is not responsible nor liable for any such use.

Also see: [Standard Terms and Conditions of Sale for Semiconductor Products](http://www.ti.com/sc/docs/stdterms.htm). www.ti.com/sc/docs/stdterms.htm

Mailing Address:

Texas Instruments
Post Office Box 655303
Dallas, Texas 75265