

# Three Phase Rectifier Bridge

$$I_{dAVM} = 121 / 157 \text{ A}$$

$$V_{RRM} = 1200-1600 \text{ V}$$

$V_{RRM}$	Type	$V_{RRM}$	Type
V	V		
1200	VUO 120-12 NO1	1600	VUO 120-16 NO1
1200	VUO 155-12 NO1	1600	VUO 155-16 NO1

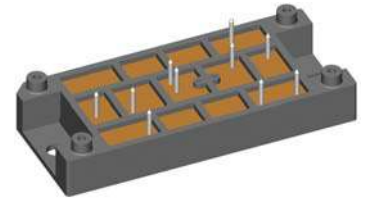
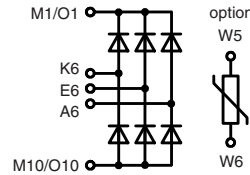

pin configuration see outlines

Symbol	Conditions	Maximum Ratings	
		VUO 120	VUO155
$V_{RRM}$		1200/1600	1200/1600 V
$I_{dAVM}$	$T_C = 75^\circ\text{C}$ , sinusoidal 120°	121	157 A
$I_{FSM}$	$T_{VJ} = 45^\circ\text{C}$ , $t = 10 \text{ ms}$ , $V_R = 0 \text{ V}$	650	850 A
	$T_{VJ} = 150^\circ\text{C}$ , $t = 10 \text{ ms}$ , $V_R = 0 \text{ V}$	580	760 A
$I^2t$	$T_{VJ} = 45^\circ\text{C}$ , $t = 10 \text{ ms}$ , $V_R = 0 \text{ V}$	2110	3610 A
	$T_{VJ} = 150^\circ\text{C}$ , $t = 10 \text{ ms}$ , $V_R = 0 \text{ V}$	1680	2880 A
$P_{tot}$	$T_C = 25^\circ\text{C}$ per diode	150	190 W
$T_{VJ}$		-40...+150	°C
$T_{VJM}$		150	°C
$T_{stg}$		-40...+125	°C
$V_{ISOL}$	50/60 Hz $t = 1 \text{ min}$	3000	V~
	$I_{ISOL} \leq 1 \text{ mA}$ $t = 1 \text{ s}$	3600	V~
$M_d$	Mounting torque (M5) (10-32 unf)	2-2.5	Nm
		18-22	lb.in.
$d_s$	Creep distance on surface	12.7	mm
$d_A$	Strike distance in air	9.4	mm
$a$	Maximum allowable acceleration	50	m/s <sup>2</sup>
Weight	typ.	80	g

## Features

- Soldering connections for PCB mounting
- Isolation voltage 3600 V~
- Convenient package outline
- UL registered E 72873
- Case and potting UL94 V-0

## Applications

- Input Rectifier for Drive Inverters

## Advantages

- Easy to mount with two screws
- Suitable for wave soldering
- High temperature and power cycling capability

Symbol	Conditions	Characteristic Values ( $T_{VJ} = 25^\circ\text{C}$ , unless otherwise specified)		
		min.	typ.	max.
$I_R$	$V_R = V_{RRM}$ , $T_{VJ} = 25^\circ\text{C}$			0.3 mA
	$V_R = V_{RRM}$ , $T_{VJ} = 150^\circ\text{C}$			5 mA
$V_F$	$I_F = 150 \text{ A}$ , $T_{VJ} = 25^\circ\text{C}$	VUO 120		1.59 V
		VUO 155		1.49 V
$V_{F0}$	For power-loss calculations only	VUO 120		0.80 V
		VUO 155		0.75 V
$r_T$	$T_{VJ} = 150^\circ\text{C}$	VUO 120		6.1 mΩ
		VUO 155		4.6 mΩ
$R_{thJC}$	per diode	VUO 120		1.0 K/W
		VUO 155		0.8 K/W
$R_{thJH}$		VUO 120		1.3 K/W
		VUO 155		1.1 K/W
$R_{25}$ (option)	Siemens S 891/2,2/+9			2.2 kΩ

## Type

## Recommended replacement

VUO120-12NO1	VUO120-12NO2T
VUO120-16NO1	VUO120-16NO2T
VUO155-12NO1	VUO120-12NO2T
VUO155-16NO1	VUO120-16NO2T

Dimensions in mm (1 mm = 0.0394")

Detail X M 2:1

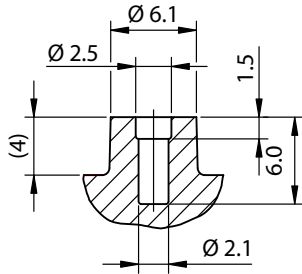

Detail Y M 5:1

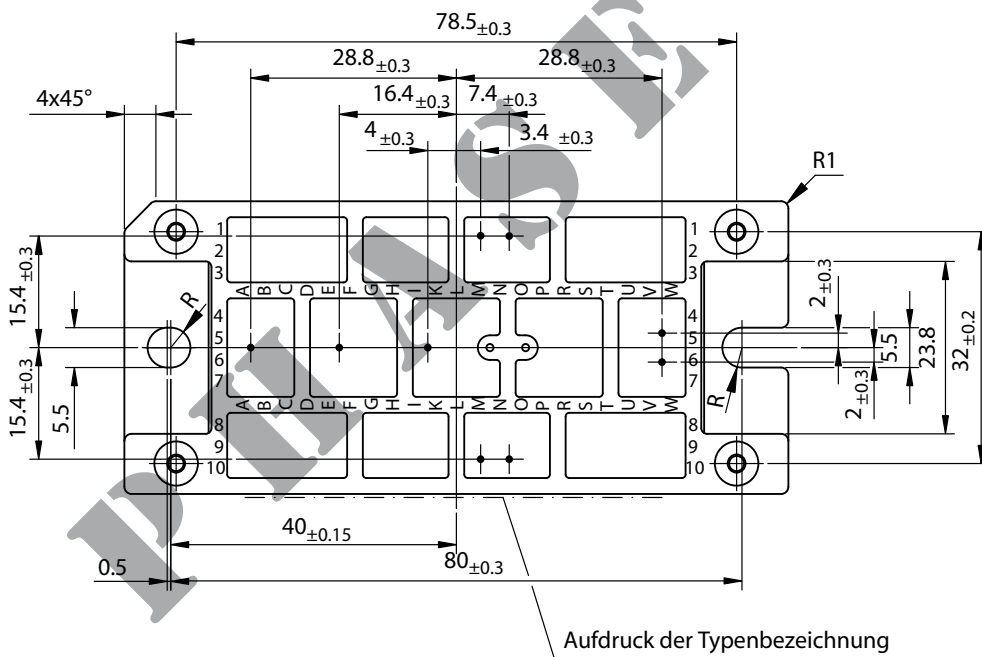
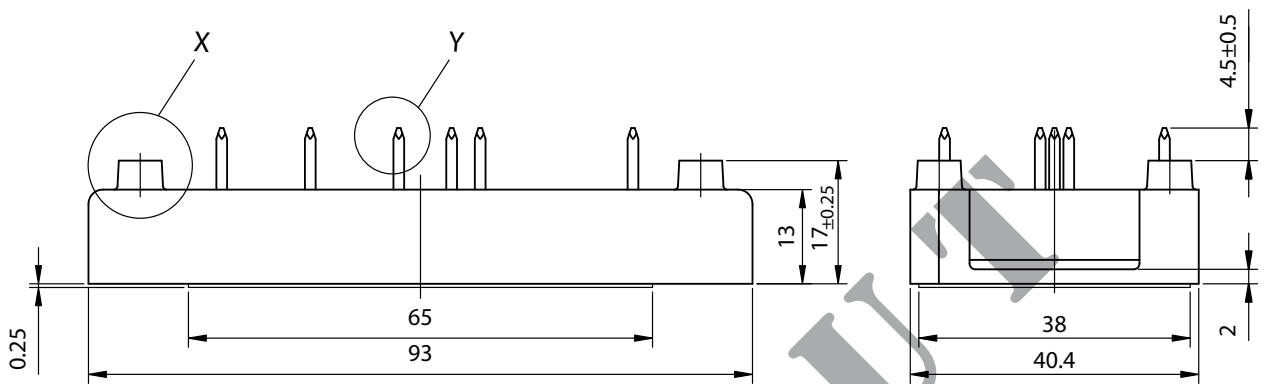
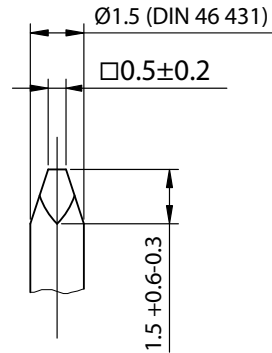

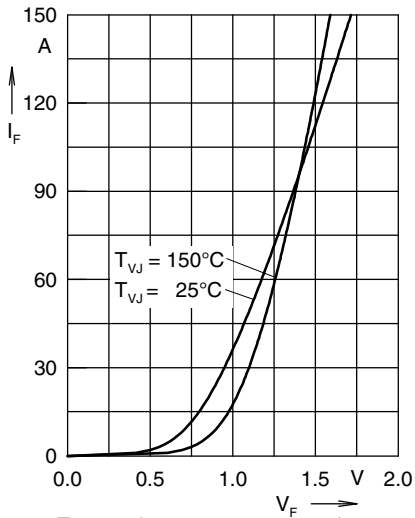

Fig. 1 Forward current versus voltage drop per diode

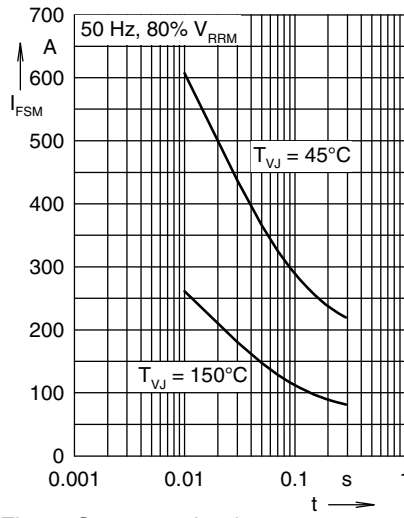

Fig. 2 Surge overload current

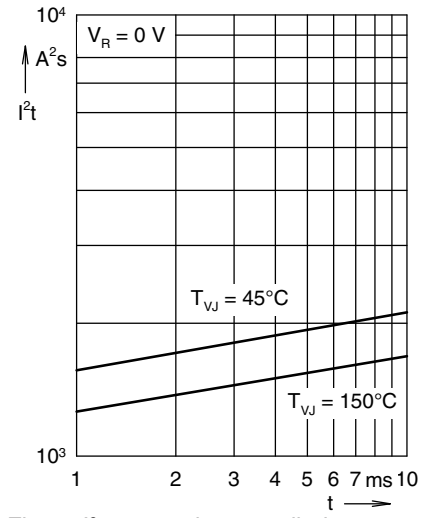

Fig. 3 I<sup>2</sup>t versus time per diode

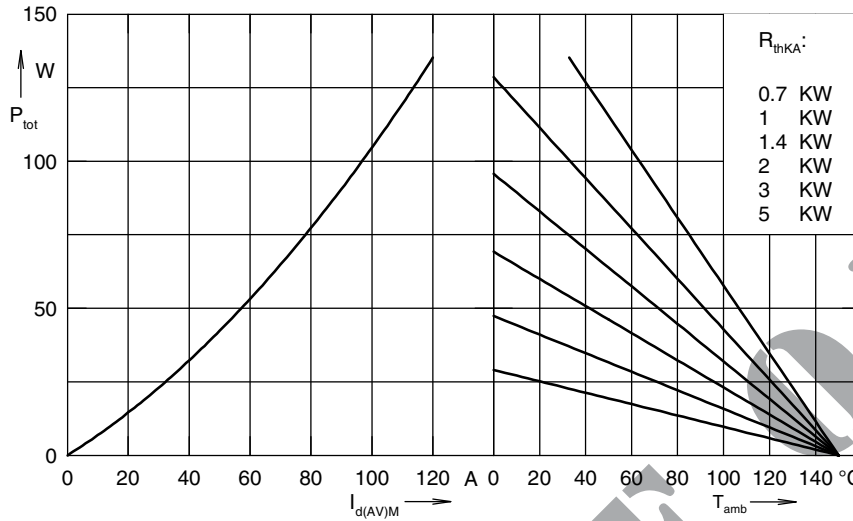

Fig. 4 Power dissipation versus direct output current and ambient temperature, sine 120°

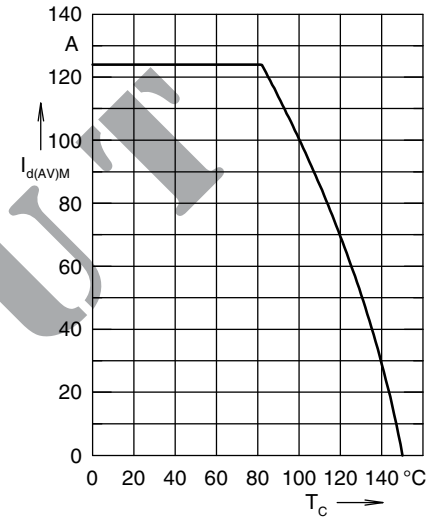

Fig. 5 Max. forward current versus case temperature

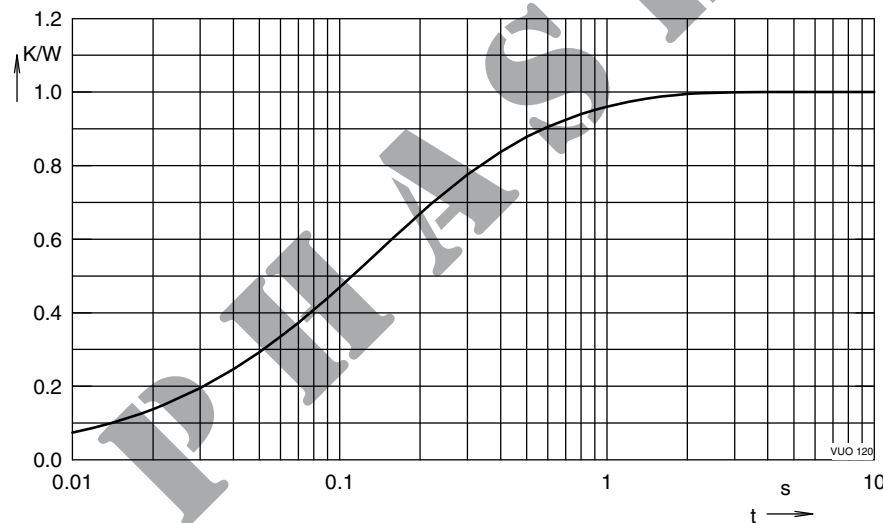

Fig. 6 Transient thermal impedance junction to case

Constants for  $Z_{thJC}$  calculation:

i	$R_{thi}$ (K/W)	$t_i$ (s)
1	0.003521	0.01
2	0.1479	0.05
3	0.5599	0.14
4	0.2887	0.5

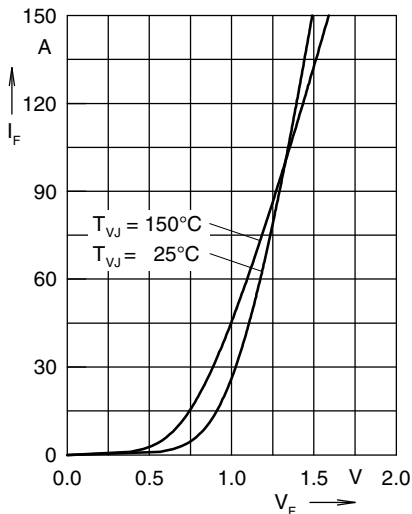

Fig. 1 Forward current versus voltage drop per diode

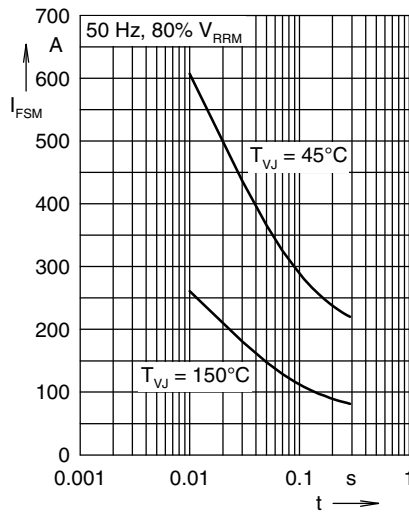

Fig. 2 Surge overload current

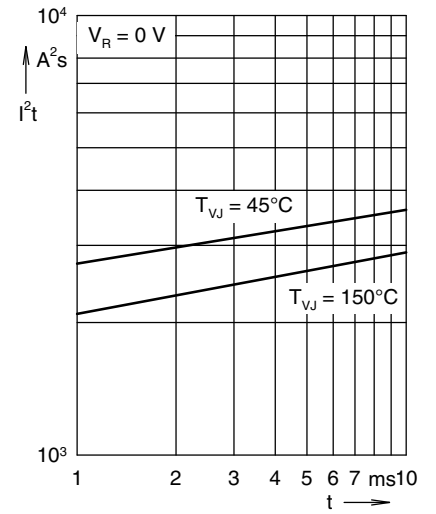

Fig. 3  $I^2t$  versus time per diode

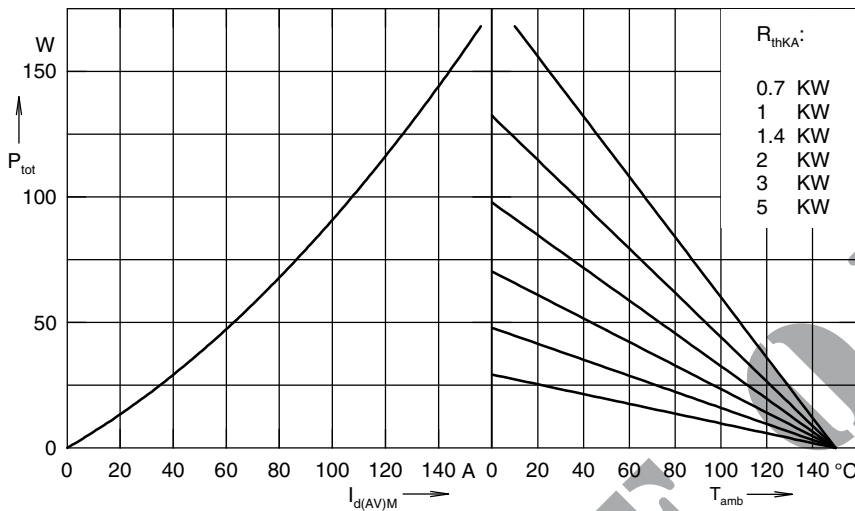

Fig. 4 Power dissipation versus direct output current and ambient temperature, sine 120°

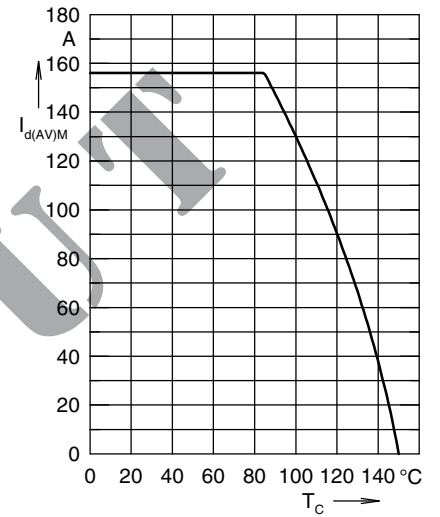

Fig. 5 Max. forward current versus case temperature

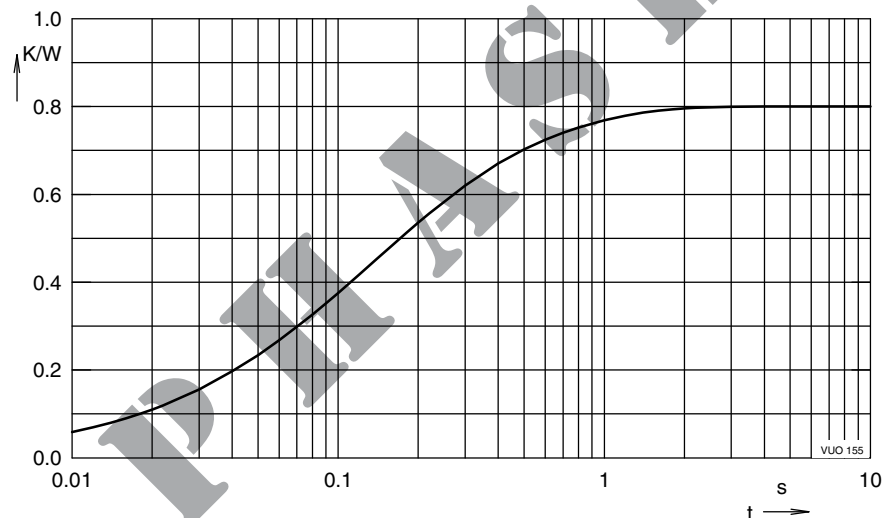

Fig. 6 Transient thermal impedance junction to case

Constants for  $Z_{thJC}$  calculation:

i	$R_{thi}$ (K/W)	$t_i$ (s)
1	0.002817	0.01
2	0.1183	0.05
3	0.4479	0.14
4	0.231	0.5