

THIS DRAWING IS UNPUBLISHED. RELEASED FOR PUBLICATION. ALL RIGHTS RESERVED.

REVISIONS					
P	LTR	DESCRIPTION	DATE	DWN	APVD
	M3	PART STATUS UPATED IN PART LIST TABLE	19FEB2018	SD	PS

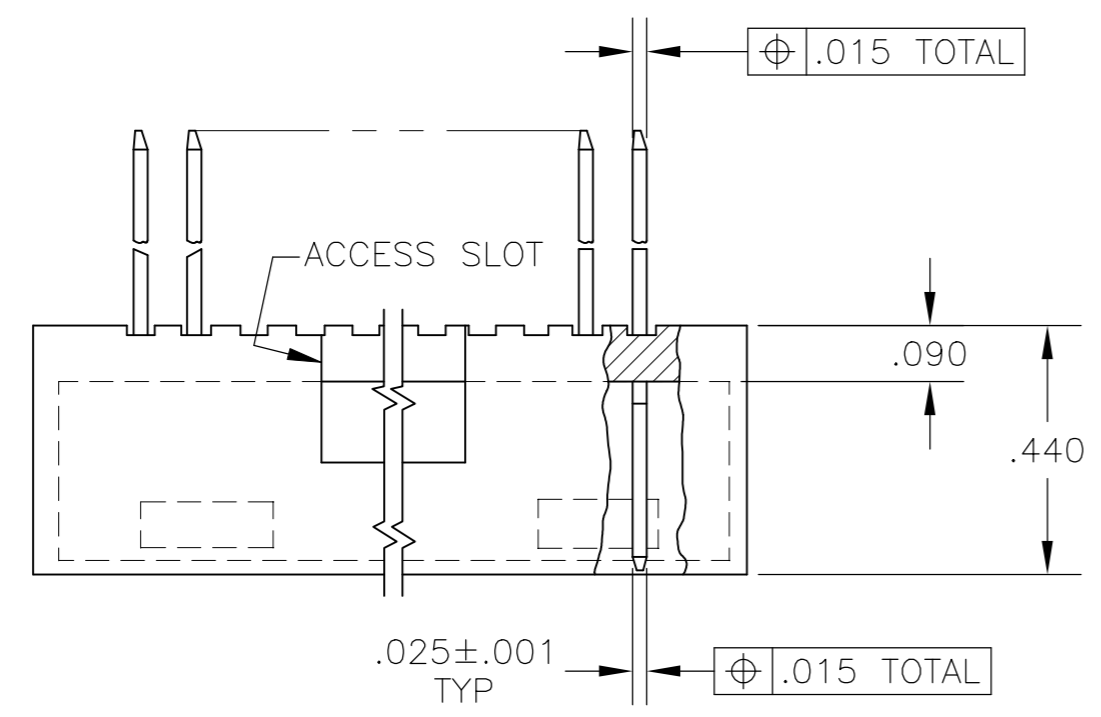

- 1 WILL ALSO MATE W/OTHER CONNECTORS WHICH ARE COMPATIBLE WITH THE .150 END DIM. WILL MATE W/MOD IV HAVING FOUR EXTRA EMPTY CIRCUITS (TWO EACH END -- EX: 20 POS HDR. POST HDR. WILL MATE W/24 POS. MOD IV HSG.)
- 2 CONTACT: .000100-.000200 BRIGHT TIN-LEAD OVER .000050 NICKEL
- 3 CONTACT: .000100-.000200 MATTE TIN OVER .000050 NICKEL
- 4 OBSOLETE PARTS: OBSOLETE CIS STREAMLINING PER D.RENAUD/D.SINISI

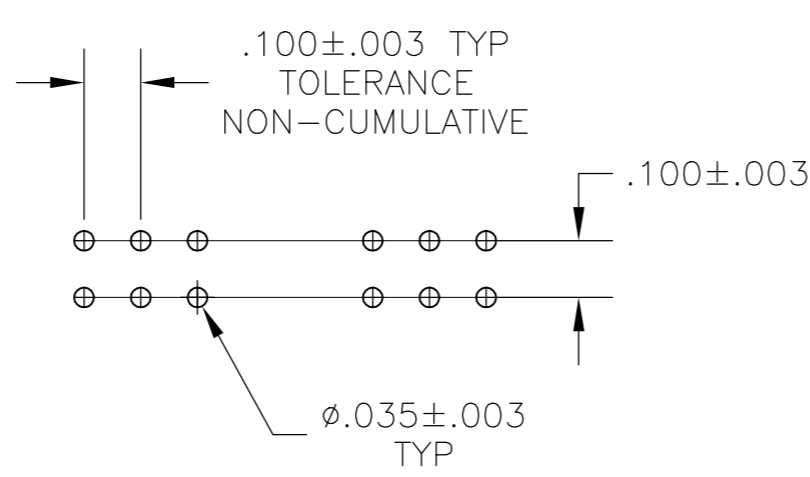
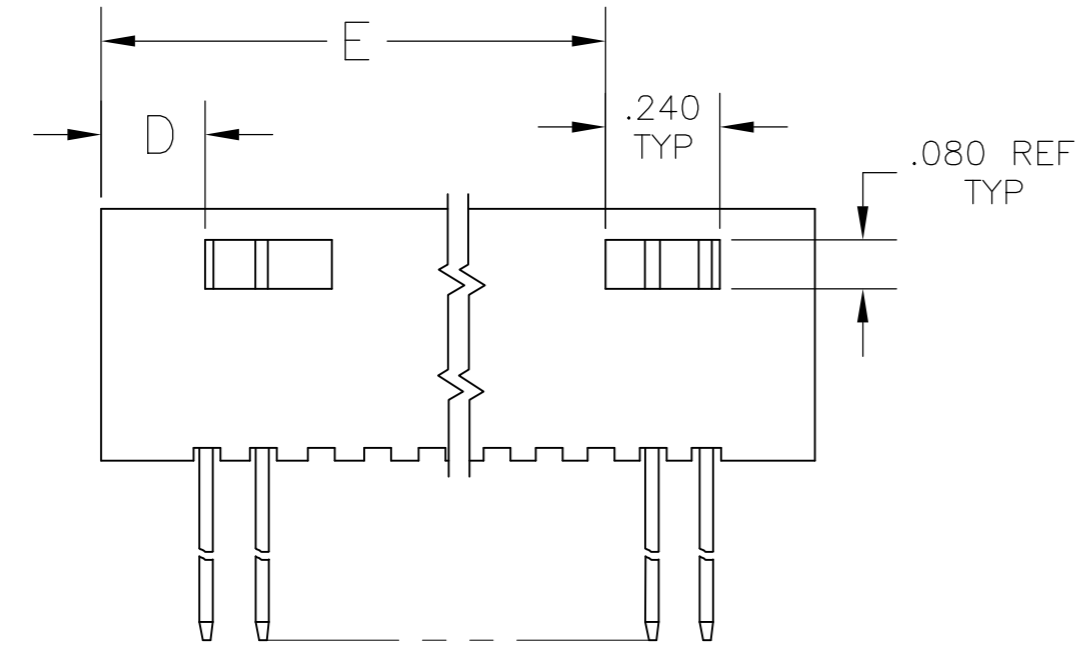
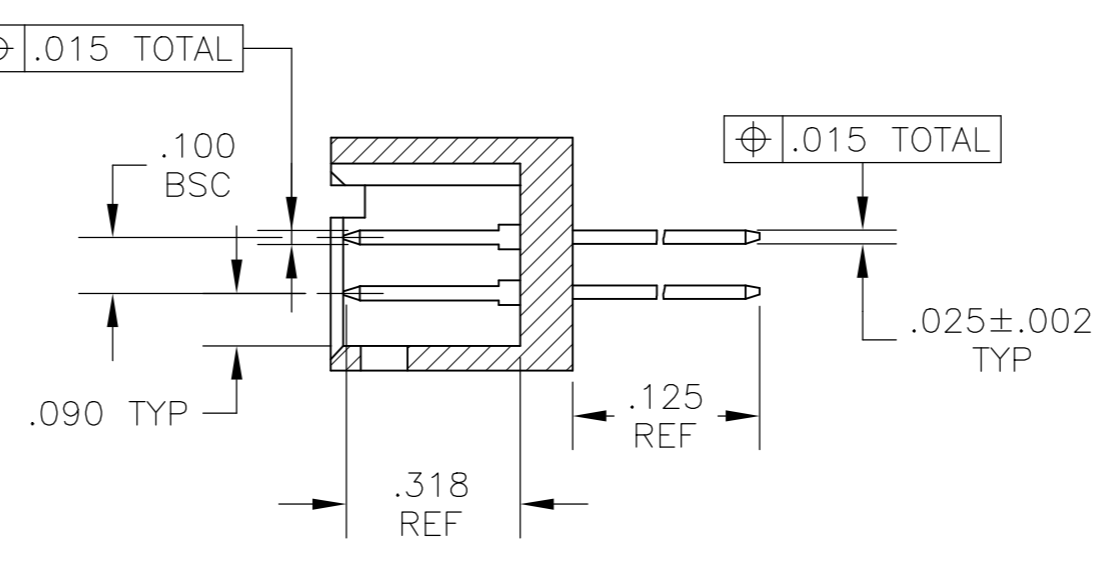
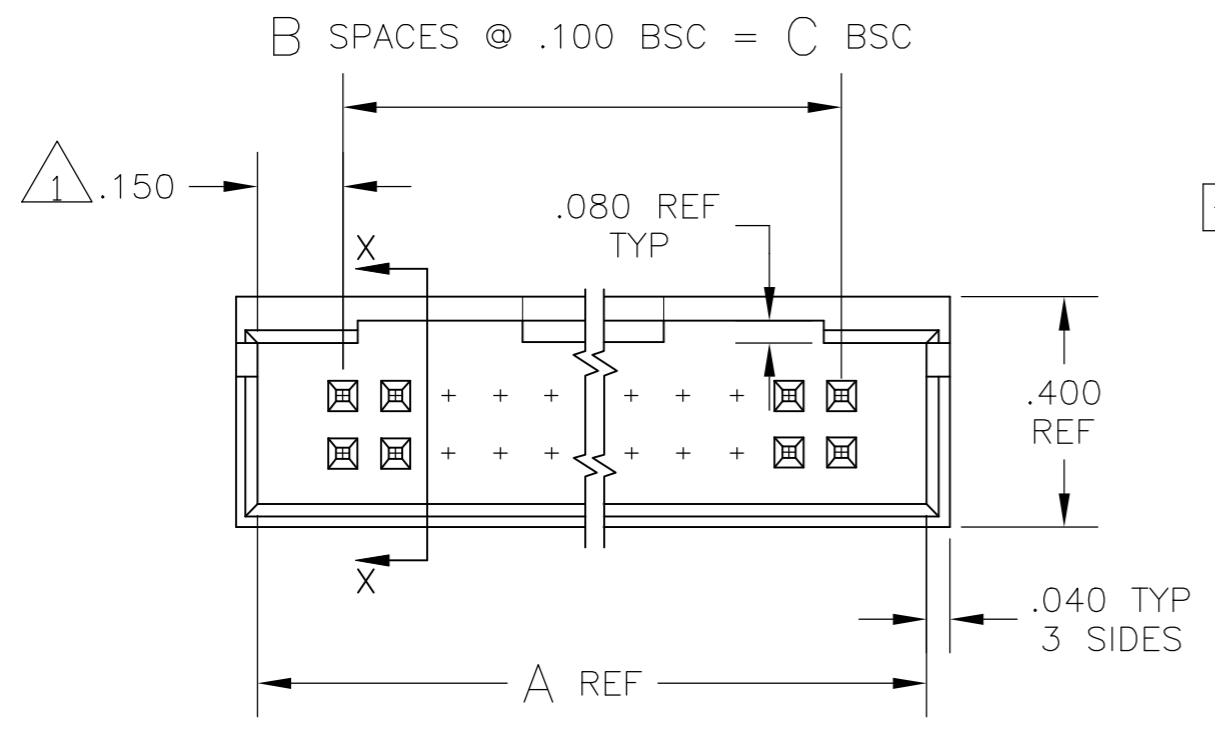

RECOMMENDED HOLE LAYOUT

THIS DRAWING IS A CONTROLLED DOCUMENT.		DWN	12 SEP 75		TE Connectivity Ltd.	
DIMENSIONS: INCHES		CHK	12 SEP 75		NAME	
		TOLERANCES UNLESS OTHERWISE SPECIFIED:		PRODUCT SPEC		
		0 PLC ± - 1 PLC ± - 2 PLC ± - 3 PLC ± .005 4 PLC ± - ANGLES ± -		APPLICATION SPEC		
MATERIAL: HSG: GLASS FILLED NYLON, COLOR: BLACK, CONTACT: PHOS BRONZE		FINISH: SEE TABLE		WEIGHT	-	
CUSTOMER DRAWING				SCALE	3:1	SHEET 1 of 2
SIZE: A2				CAGE CODE: 00779	DRAWING NO: C=87587	RESTRICTED TO: -
				REV	M3	

THIS DRAWING IS UNPUBLISHED. RELEASED FOR PUBLICATION  
 © COPYRIGHT - By - ALL RIGHTS RESERVED.

REVISIONS					
P	LTR	DESCRIPTION	DATE	DWN	APVD
-	-	SEE SHEET 1	-	-	-

PLATING	E	D	C	B	A	NO OF POSN.	PART NO.
3	-	.190	.300	3	.600	8	8-87587-4
3	-	.190	.200	2	.500	6	8-87587-3
3	3.490	.190	3.500	35	3.800	72	8-87587-2
3	3.390	.190	3.400	34	3.700	70	8-87587-1
3	3.290	.190	3.300	33	3.600	68	8-87587-0
3	3.190	.190	3.200	32	3.500	66	7-87587-9
3	3.090	.190	3.100	31	3.400	64	7-87587-8
3	2.990	.190	3.000	30	3.300	62	7-87587-7
3	2.890	.190	2.900	29	3.200	60	7-87587-6
3	2.790	.190	2.800	28	3.100	58	7-87587-5
3	2.690	.190	2.700	27	3.000	56	7-87587-4
3	2.590	.190	2.600	26	2.900	54	7-87587-3
3	2.490	.190	2.500	25	2.800	52	7-87587-2
3	2.390	.190	2.400	24	2.700	50	7-87587-1
3	2.290	.190	2.300	23	2.600	48	7-87587-0
3	2.190	.190	2.200	22	2.500	46	6-87587-9
3	2.090	.190	2.100	21	2.400	44	6-87587-8
3	1.990	.190	2.000	20	2.300	42	6-87587-7
3	1.890	.190	1.900	19	2.200	40	6-87587-6
3	1.790	.190	1.800	18	2.100	38	6-87587-5
3	1.690	.190	1.700	17	2.000	36	6-87587-4
3	1.590	.190	1.600	16	1.900	34	6-87587-3
3	1.490	.190	1.500	15	1.800	32	6-87587-2
3	1.390	.190	1.400	14	1.700	30	6-87587-1
3	1.290	.190	1.300	13	1.600	28	6-87587-0
3	1.190	.190	1.200	12	1.500	26	5-87587-9
4	1.090	.190	1.100	11	1.400	24	5-87587-8
3	.990	.190	1.000	10	1.300	22	5-87587-7
3	.890	.190	.900	9	1.200	20	5-87587-6
4	-	.490	.800	8	1.100	18	5-87587-5
3	-	.390	.700	7	1.000	16	5-87587-4
3	-	.390	.600	6	.900	14	5-87587-3
4	-	.290	.500	5	.800	12	5-87587-2
3	-	.290	.400	4	.700	10	5-87587-1

OBSOLETE

OBSOLETE

4

4

4

PLATING	E	D	C	B	A	NO OF POSN.	PART NO.
2	-	.190	.300	3	.600	8	3-87587-4
2	-	.190	.200	2	.500	6	3-87587-3
2	3.490	.190	3.500	35	3.800	72	3-87587-2
2	3.390	.190	3.400	34	3.700	70	3-87587-1
2	3.290	.190	3.300	33	3.600	68	3-87587-0
2	3.190	.190	3.200	32	3.500	66	2-87587-9
2	3.090	.190	3.100	31	3.400	64	2-87587-8
2	2.990	.190	3.000	30	3.300	62	2-87587-7
2	2.890	.190	2.900	29	3.200	60	2-87587-6
2	2.790	.190	2.800	28	3.100	58	2-87587-5
2	2.690	.190	2.700	27	3.000	56	2-87587-4
2	2.590	.190	2.600	26	2.900	54	2-87587-3
2	2.490	.190	2.500	25	2.800	52	2-87587-2
2	2.390	.190	2.400	24	2.700	50	2-87587-1
2	2.290	.190	2.300	23	2.600	48	2-87587-0
2	2.190	.190	2.200	22	2.500	46	1-87587-9
2	2.090	.190	2.100	21	2.400	44	1-87587-8
2	1.990	.190	2.000	20	2.300	42	1-87587-7
2	1.890	.190	1.900	19	2.200	40	1-87587-6
2	1.790	.190	1.800	18	2.100	38	1-87587-5
2	1.690	.190	1.700	17	2.000	36	1-87587-4
2	1.590	.190	1.600	16	1.900	34	1-87587-3
2	1.490	.190	1.500	15	1.800	32	1-87587-2
2	1.390	.190	1.400	14	1.700	30	1-87587-1
2	1.290	.190	1.300	13	1.600	28	1-87587-0
2	1.190	.190	1.200	12	1.500	26	87587-9
4	1.090	.190	1.100	11	1.400	24	87587-8
2	.990	.190	1.000	10	1.300	22	87587-7
2	.890	.190	.900	9	1.200	20	87587-6
4	-	.490	.800	8	1.100	18	87587-5
2	-	.390	.700	7	1.000	16	87587-4
2	-	.390	.600	6	.900	14	87587-3
4	-	.290	.500	5	.800	12	87587-2
2	-	.290	.400	4	.700	10	87587-1

OBSOLETE

SUPERSEDED

OBSOLETE

4

4

4

THIS DRAWING IS A CONTROLLED DOCUMENT.

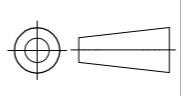
DWN	12 SEP 75	 TE Connectivity Ltd.
CHK	12 SEP 75	
APVD	15 SEP 75	
DIMENSIONS: INCHES 		NAME
TOLERANCES UNLESS OTHERWISE SPECIFIED: 0 PLC ± - 1 PLC ± - 2 PLC ± - 3 PLC ± .005 4 PLC ± - ANGLES ± -		HDR ASSY MOD II, .100 C/L .025 SQ POST, W/ DETENT (MATES WITH AMP LATCH OR FFC)
MATERIAL	FINISH	SIZE
HSG: GLASS FILLED NYLON COLOR: BLACK CONTACT: PHOS BRONZE	SEE TABLE	A2 00779
CUSTOMER DRAWING		DRAWING NO
		C=87587
		RESTRICTED TO
		SCALE 1:1
		SHEET 2 of 2
		REV M3