

DESCRIPTION

The EV4473-L-00A is an evaluation board for the MPQ4470, a high-efficiency step-down regulator with integrated power MOSFETs.

MPQ4470 offers a very compact solution to achieve a 5A, continuous-output current over a wide input-supply range with excellent load and line regulation. It also provides fast transient response and good stability for wide input-supply and load range.

The EV4473-L-00A is a fully assembled and tested evaluation board. It generates a +3.3V output voltage at load current up to 5A from an 4.5V to 36V input range. Switching frequency is set at 500kHz.

This evaluation board is available for both EV4473 and EVQ4473

ELECTRICAL SPECIFICATIONS

Parameter	Symbol	Value	Units
Input Voltage	V_{IN}	4.5 – 36	V
Output Voltage	V_{OUT}	3.3	V
Output Current	I_{OUT}	3.5	A

FEATURES

- Wide 4.5V-to-36V Operating Input Range
- Guarantee 5A, Continuous Output Current
- Internal 40mΩ High-Side, 20mΩ Low-Side Power MOSFETs
- Proprietary Switching-Loss-Reduction Technology
- 1% Reference Voltage
- Programmable Soft-Start Time
- Low Drop-out Mode
- SCP, OCP, OVP, UVP and Thermal Shutdown

APPLICATIONS

- Notebook Systems and I/O Power
- Automotive Systems
- Networking Systems
- Industrial Supplies
- Optical Communications Systems
- Distributed Power and POL Systems

All MPS parts are lead-free and adhere to the RoHS directive. For MPS green status, please visit MPS website under Quality Assurance. "MPS" and "The Future of Analog IC Technology" are Registered Trademarks of Monolithic Power Systems, Inc.

EV4473-L-00A EVALUATION BOARD

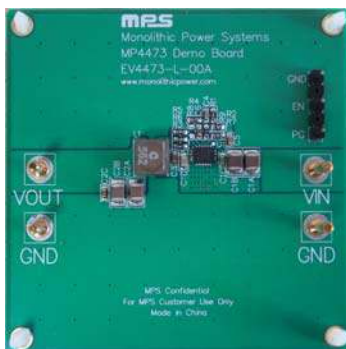

(L x W x H) 2.5" x 2.5" x 0.4"
(6.4cm x 6.4cm x 1.0cm)

Board Number	MPS IC Number
EV4473-L-00A	MPQ4473GL

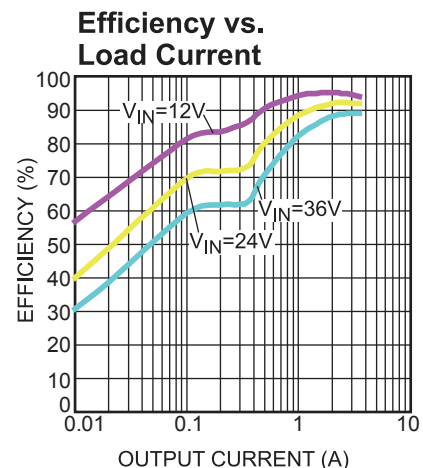

EVALUATION BOARD SCHEMATIC

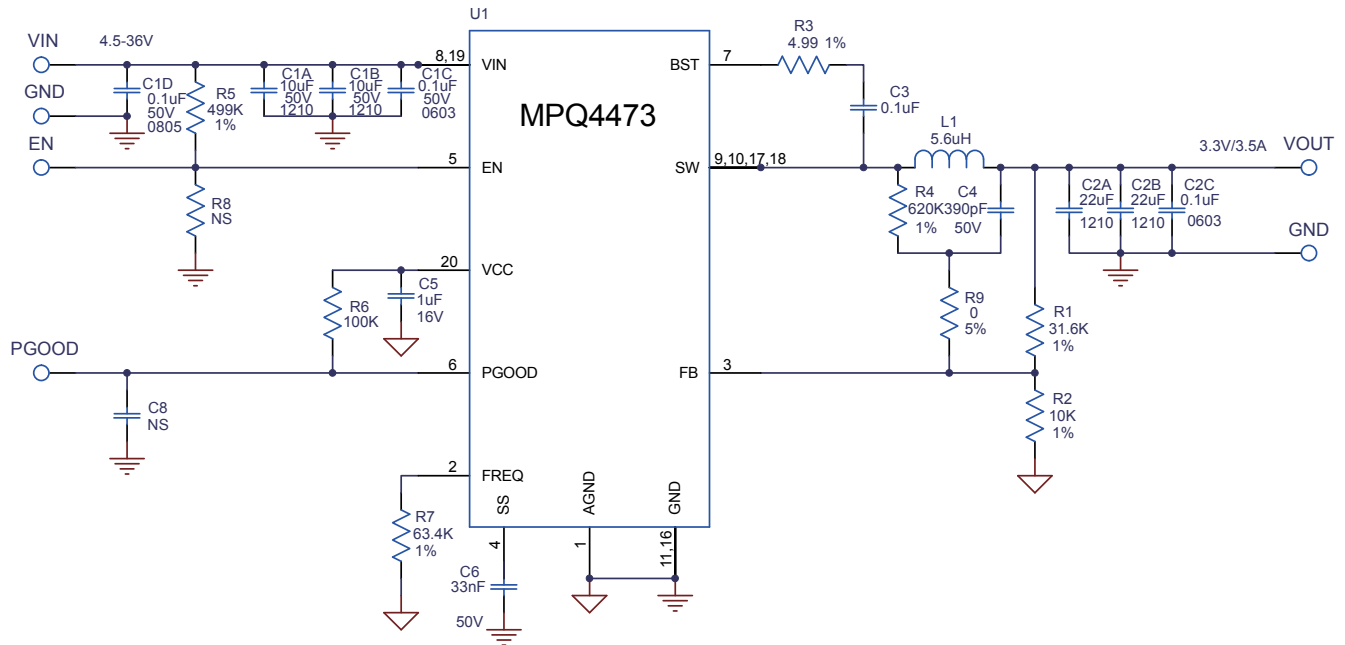

EV4473-L-00A BILL OF MATERIALS

Qty	RefDes	Value	Description	Package	Manufacturer	Manufacturer_P/N
2	C1A,C1B	10 μ F	Ceramic Cap., 50V, X7R	1210	muRata	GRM32ER71H106KA12L
3	C1C,C2C, C3	0.1 μ F	Ceramic Cap., 50V, X7R	0603	TDK	C1005X7R1C104K
1	C1D	0.1 μ F	Ceramic Cap., 50V, X7R	0805	muRata	GRM21BR72A104KAC4L
2	C2A,C2B	22 μ F	Ceramic Cap., 16V, X7R	1210	muRata	GRM32ER71C226KE79
1	C4	390pF	Ceramic Cap., 50V, C0G	0402	muRata	GRM1885C1H391JA01D
1	C5	1 μ F	Ceramic Cap., 25V, X7R	0402	muRata	GRM188R71C105KA12D
1	C6	33nF	Ceramic Cap., 16V, X7R	0402	muRata	GRM188R71H333KA61D
1	L1	5.6 μ H	Inductor, 15mOhm DCR, 10A	SMD	Coilcraft	XAL6060-562ME
1	R1	31.6k	Film Res., 1%	0402	Yageo	RC0603FR-0731K6L
1	R2	10k	Film Res., 1%	0402	Yageo	RC0603FR-0710KL
1	R3	4.99 Ω	Film Res., 1%	0402	Yageo	RC0603FR-074R99L
1	R4	620k	Film Res., 1%	0402	Yageo	RC0603FR-07620KL
1	R5	499k	Film Res., 1%	0402	Yageo	RC0603FR-07499KL
1	R6	100k	Film Res., 5%	0402	Yageo	RC0603FR-07100KL
1	R7	63.4k	Film Res., 1%	0402	Yageo	RC0603FR-0763K4L
1	R9	0 Ω	Film Res., 5%	0402	Yageo	RC0603FR-070RL
	R8	NS				
1	U1	MPQ4473	Step-Down Regulator	QFN20- 3x4	MPS	MPQ4473GL

EVB TEST RESULTS

Performance waveforms are tested on the evaluation board.

$V_{IN} = 24V$, $V_{OUT} = 3.3V$, $T_A = 25^\circ C$, unless otherwise noted.

Efficiency vs. Load Current

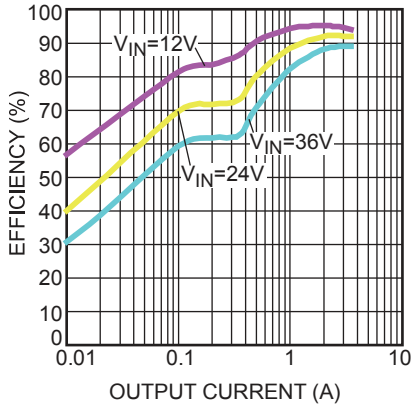

Case Temperature Rise vs. Output Current

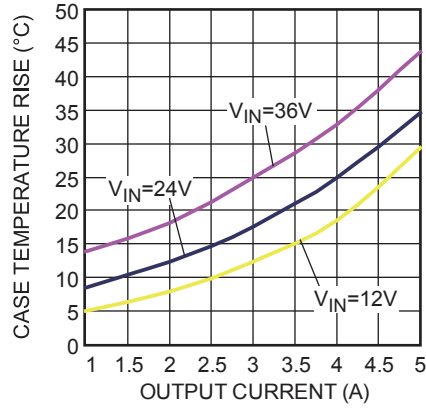

F_{SW} vs. Output Current

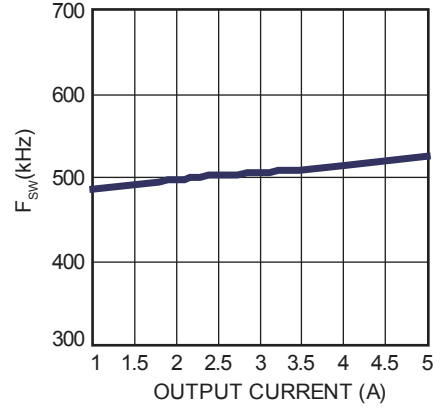

F_{SW} vs. V_{IN}

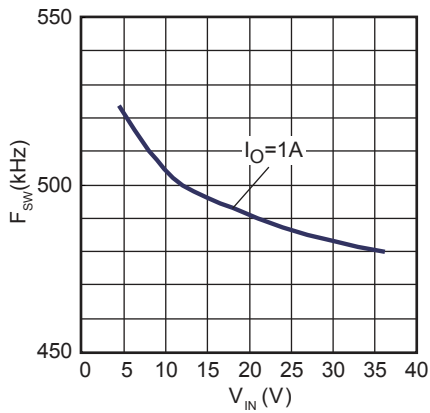

Line Regulation

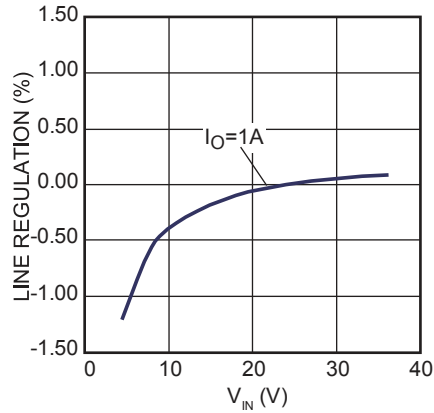

Load Regulation

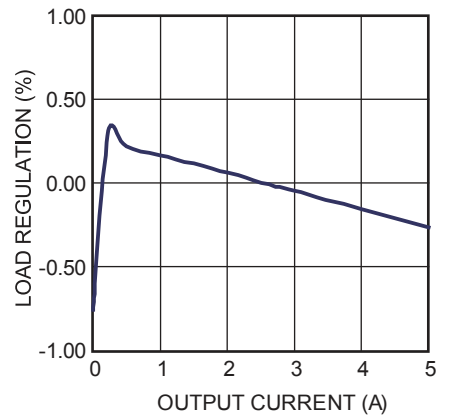

EVB TEST RESULTS (continued)

Performance waveforms are tested on the evaluation board.

 $V_{IN} = 24V$, $V_{OUT} = 3.3V$, $T_A = 25^\circ C$, unless otherwise noted.

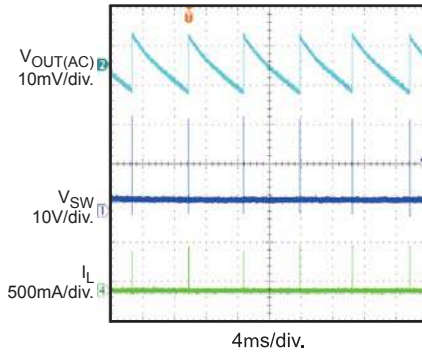
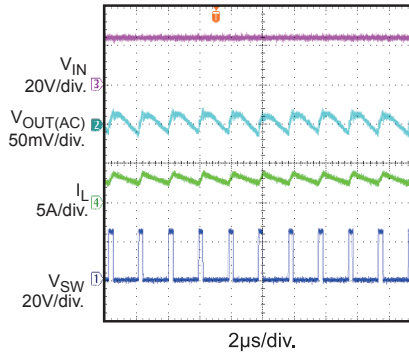
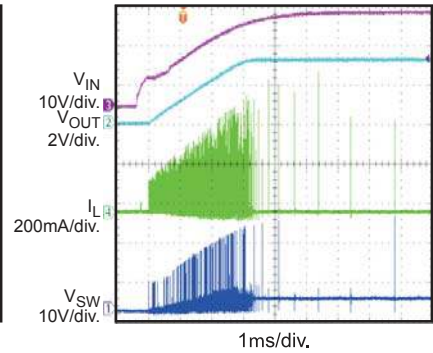
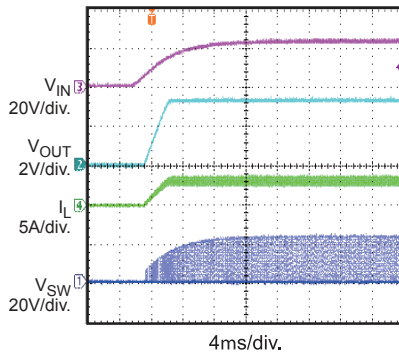
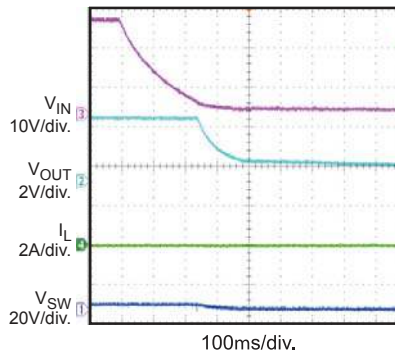
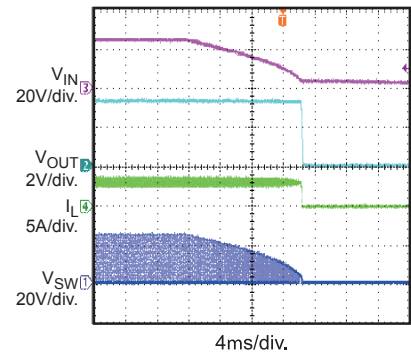
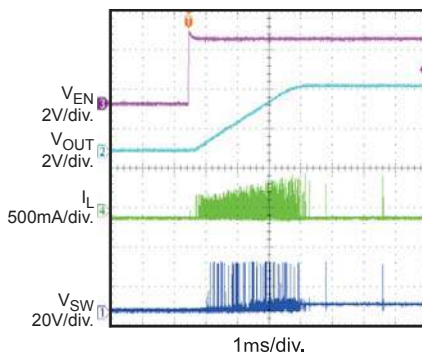
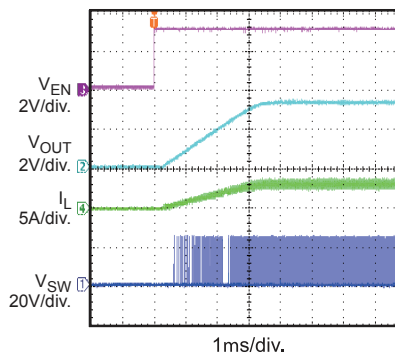
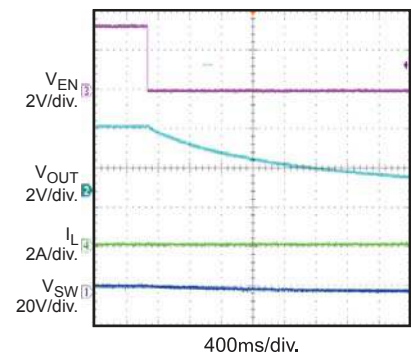
Output Voltage Ripple
 $I_{OUT} = 0A$

Output Voltage Ripple
 $I_{OUT} = 3A$

Start-up Through V_{IN}
 $I_{OUT} = 0A$

Start-up Through V_{IN}
 $I_{OUT} = 3A$

Shutdown Through V_{IN}
 $I_{OUT} = 0A$

Shutdown Through V_{IN}
 $I_{OUT} = 3A$

Start-up Through EN
 $I_{OUT} = 0A$

Start-up Through EN
 $I_{OUT} = 3A$

Shutdown Through EN
 $I_{OUT} = 0A$

EVB TEST RESULTS *(continued)*

Performance waveforms are tested on the evaluation board.

$V_{IN} = 24V$, $V_{OUT} = 3.3V$, $T_A = 25^{\circ}C$, unless otherwise noted.

Shutdown Through EN

$I_{OUT} = 3A$

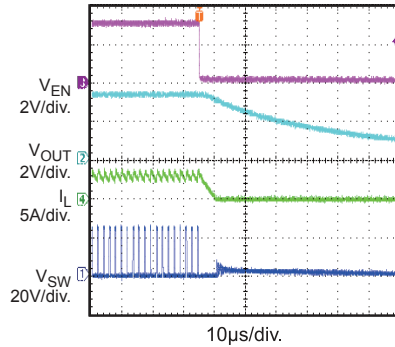

Short Circuit Entry

$I_{OUT} = 0A$

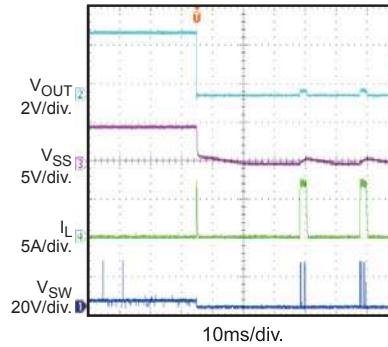

Short Circuit Entry

$I_{OUT} = 3A$

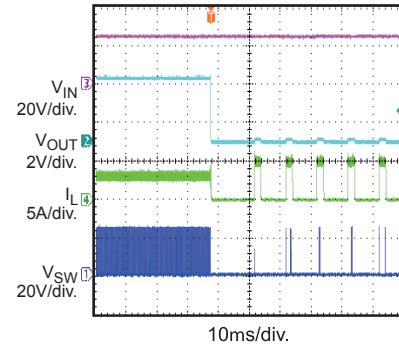

Short Circuit Steady State

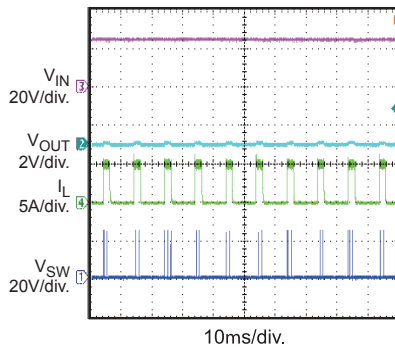

Load Transient

$I_{OUT} = 1A-3A$

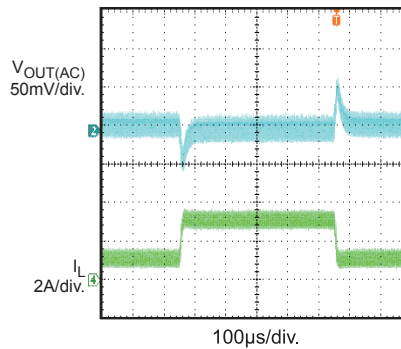

Short Circuit Recovery

$I_{OUT} = 0A$

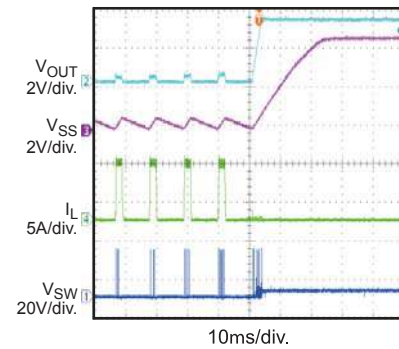

Short Circuit Recovery

$I_{OUT} = 3A$

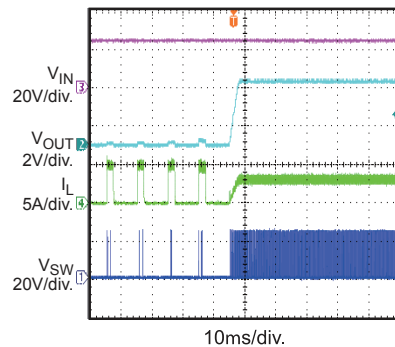

Power Good Through EN Start-up

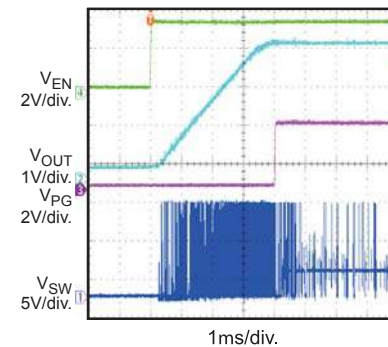

Power Good Through EN Shutdown

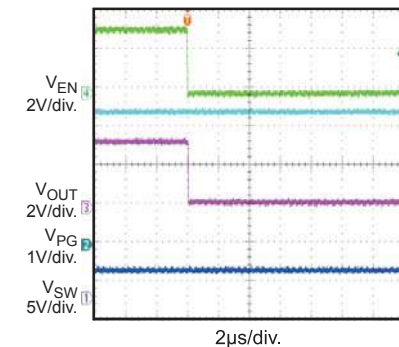

PRINTED CIRCUIT BOARD LAYOUT

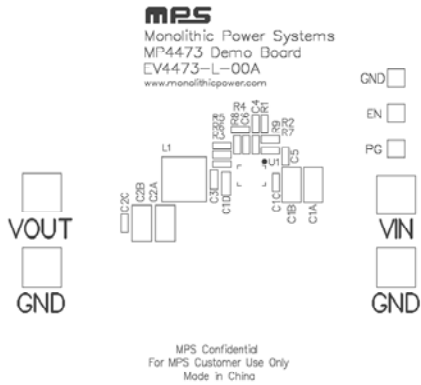

Figure 1—Top Silk Layer

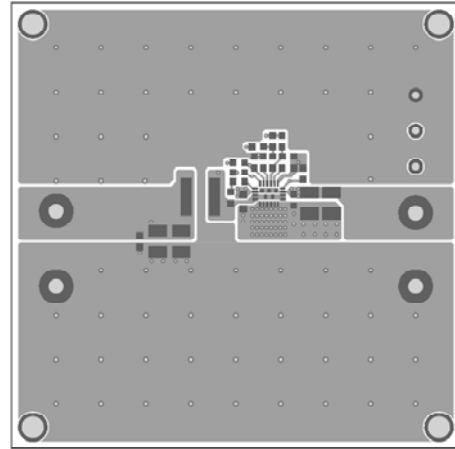

Figure 2—Top Layer

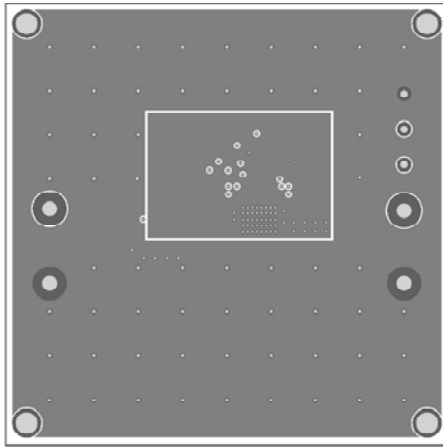

Figure 3—Inner1 Layer

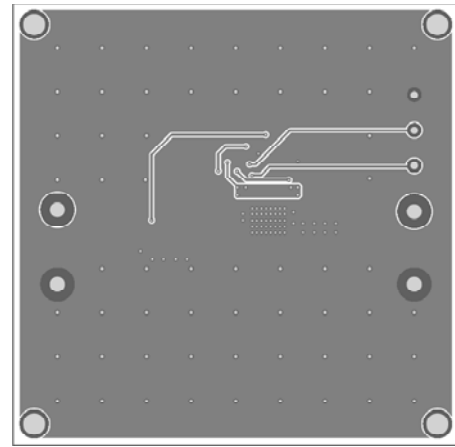

Figure 4—Inner2 Layer

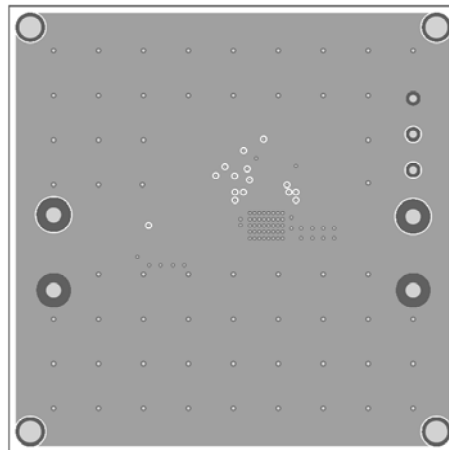

Figure 5—Bottom Layer

QUICK START GUIDE

1. Connect the positive and negative terminals of the load to the VOUT and GND pins, respectively.
2. Preset the power supply output to between 4.5 and 36V, and then turn it off.
3. Connect the positive and negative terminals of the power supply output to the VIN and GND pins, respectively.
4. Turn the power supply on. The MPQ4473GL will automatically startup.
5. To use the Enable function, apply a digital input to the EN pin. Drive EN higher than 1.25V to turn on the regulator, drive EN less than 0.86V to turn it off.
6. An input under voltage lockout (UVLO) function is implemented by the addition of a resistor divider R5 and R8. The EN threshold is 0.86V (falling edge), so V_{IN} UVLO threshold is.
$$0.86 \times \left(1 + \frac{R5}{R8}\right)$$
7. Use R1 and R2 to set the output voltage with $V_{FB} = 0.815V$. For $R2 = 10k\Omega$, R1 can be determined by: $R1 = 12.27 \times (V_{OUT} - 0.815)$ (k Ω). Follow the Application Information section in the device datasheet to recalculate the compensation, inductor and output capacitor values when output voltage is changed.

NOTICE: The information in this document is subject to change without notice. Users should warrant and guarantee that third party Intellectual Property rights are not infringed upon when integrating MPS products into any application. MPS will not assume any legal responsibility for any said applications.