

Digital Fiber Sensor

FX-410 SERIES

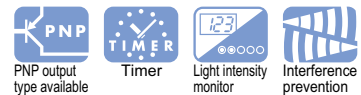

FX-410 SERIES



Just “Look” and “Turn”, Simple, easy-to-use fiber sensor

Incident light intensity and threshold value are displayed simultaneously

The incident light intensity and threshold value can be checked at the same time with no operations needed. In addition, no complex mode settings are needed when the values are adjusted.

Adjustment variations according to the individual have been eliminated

Accurate control of the adjuster threshold values by using numerical values is possible due to the digital display. This allows anybody to perform the same settings.

Easy-to-understand operating panel layout

The threshold value adjuster and operation mode switch are large and easy to see, and they can be operated with the same sensitivity as general-purpose photoelectric sensors. Functions which are not commonly used can be operated using a non-obtrusive setting switch.

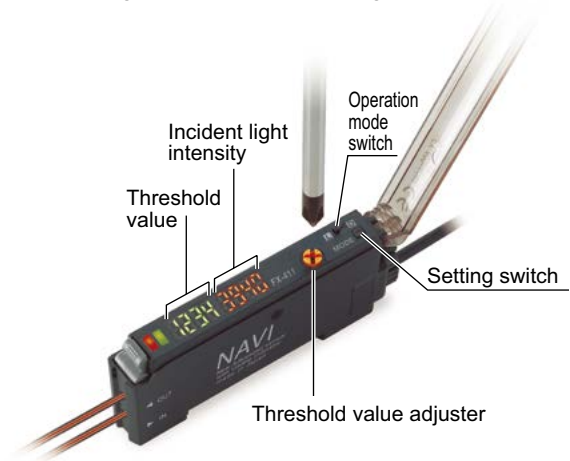

Threshold values can be changed smoothly

This sensor uses the R.S.S.* adjuster with a compact encoder inside. The sensitivity amount changes depending on the rotation speed of the adjuster, so that adjustment can be carried out speedily.

* Rotation Speed Sensitivity

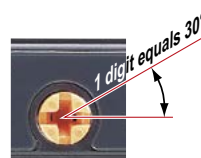
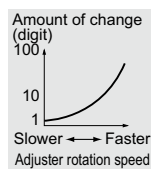
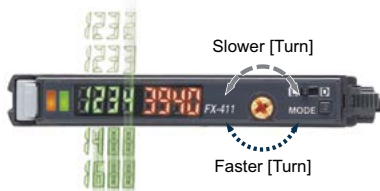

Adjustment in units of 1 digit is also easy
No need for the fine changes in force required for photoelectric sensors.

Large endless adjuster

New concept

Standard screwdrivers can be used to turn the adjuster as well as precision screwdrivers. In addition, an “endless” mechanism is used which eliminates the possibility of any damage being caused by turning the adjuster too far.



FX-412 can be turned by finger!

New concept

The adjuster can be turned directly by finger, without the need for a screwdriver.



Beam power greatly increased to give strong performance under adverse environments

Red LED type

The beam power has been greatly increased. This means a longer sensing distance and less trouble from problems such as dust. These sensors have ample performance for workplace needs.

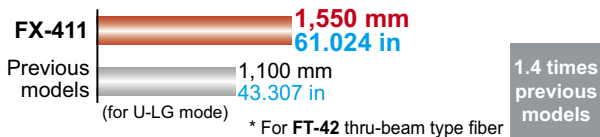

Three types are available, with red, blue and green light

Different sensors can be selected to suit the application.



Improved stability over both long and short terms

Red LED type

The red LED type sensors have a “four-chemical emitting element” which maintains stability of light emissions for long-term operation. Furthermore, all models have an “APC (Auto Power Control) circuit” which improves stability at times such as when the power is turned on. These features improve overall stability compared to previous models.

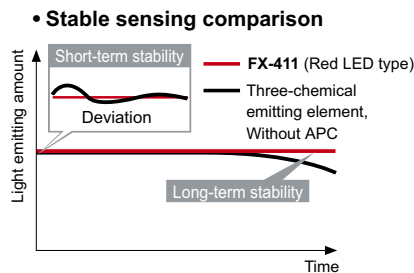

Color combinations that can be discerned during mark sensing

Mark color / Back ground color	White	Yellow	Orange	Red	Green	Blue	Black
White		●	●	●●	●●●	●●●	●●●
Yellow	●		●	●●	●●●	●●●	●●●
Orange	●	●		●●	●●●	●●●	●●●
Red	●●	●	●		●	●●	●●
Green	●●●	●●●	●●●	●		●	●
Blue	●●●	●●●	●●●	●●	●		●
Black	●●●	●●●	●●●	●●	●	●	

●: Red LED type ●: Blue LED type ●: Green LED type

Excellent workability and ease of maintenance

Connector type

The same quick-connection cable that is used for sensors such as the FX-300 series of digital fiber sensors is used. This means that they can be used together with other types of sensors such as laser sensors, and the number of power supply cables can be reduced.

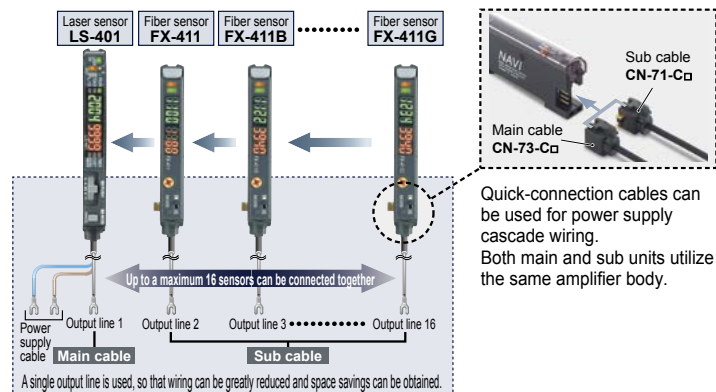

The sensors can be connected together with other sensors such as the FX-300 series of digital fiber sensors and the GA-311 of inductive proximity sensors. In addition, the SC series of sensor PLC connection units with MIL connector compatibility can also be used to further reduce the amount of wiring (P.987~).

Contributing to device miniaturization

This fiber sensor is the smallest among the dual digital display types, contributing to device miniaturization.



Equipped with 3 types timers

Equipped with OFF-delay / ON-delay / ONE SHOT timer. (Timer period: 1 ms to 3 sec. approx.)

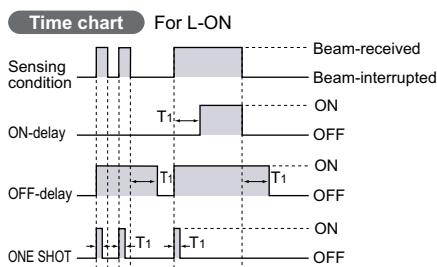

Interference prevention for up to 8 sets fiber heads (for U-LG)

The optical communication function allows up to a maximum of eight sets of fiber heads (four sets for FAST and STD settings) to be installed in contact with each other without mutual interference occurring. (Set automatically when power is turned on.)

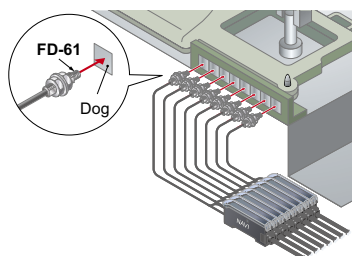

Key lock function prevents wrong operation

This prevents the operator from changing the threshold value by mistake.

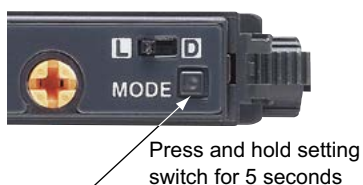

Ideal for dealing with saturation / Light-emitting amount selection function

Red LED type **New concept**

In cases where the incoming light level can become saturated, such as during close-range sensing or when sensing transparent or minute objects, the sensor's light-emitting amount can be adjusted to provide more stable sensing without changing the response time.

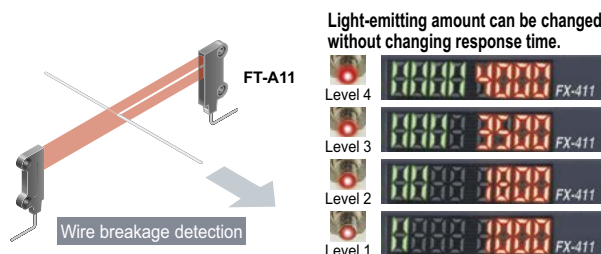

Digital display upside-down / off function

The digital display can be turned upside-down if required to suit the setup location. In addition, a stability indicator is also provided, so that the amount of light-receiving excess can be checked even when the display is turned off.



Hold function

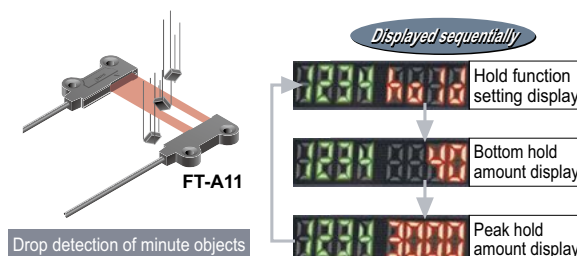

Peak and bottom hold values for the incident light intensity can be displayed. This is useful for checking the incident light intensity during tasks such as drop detection.

In addition, the peak and bottom values can be checked while looking at the threshold value, which makes adjustment much easier.



ORDER GUIDE

Amplifiers Quick-connection cable is not supplied with the amplifier. Please order it separately.

Type	Appearance	Model No.	Emitting element	Output
NPN output		FX-411	Red LED	NPN open-collector transistor
		FX-411B	Blue LED	
		FX-411G	Green LED	
PNP output		FX-411P	Red LED	PNP open-collector transistor
		FX-411BP	Blue LED	
		FX-411GP	Green LED	
NPN output		FX-412 (Note)	Red LED	NPN open-collector transistor
		FX-412B (Note)	Blue LED	
		FX-412G (Note)	Green LED	

Note: The **FX-412** has a threshold value adjuster that can be adjusted with your fingers.

Quick-connection cables Quick-connection cable is not supplied with the amplifier. Please order it separately.

Type	Model No.	Description	
Main cable (3-core)	CN-73-C1	Length: 1 m 3.281 ft	0.2 mm ² 3-core cabtyre cable, with connector on one end Cable outer diameter: \varnothing 3.3 mm \varnothing 0.130 in
	CN-73-C2	Length: 2 m 6.562 ft	
	CN-73-C5	Length: 5 m 16.404 ft	
Sub cable (1-core)	CN-71-C1	Length: 1 m 3.281 ft	0.2 mm ² 1-core cabtyre cable, with connector on one end Cable outer diameter: \varnothing 3.3 mm \varnothing 0.130 in
	CN-71-C2	Length: 2 m 6.562 ft	
	CN-71-C5	Length: 5 m 16.404 ft	

Main cable

- **CN-73-C**

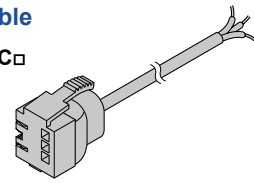

Sub cable

- **CN-71-C**

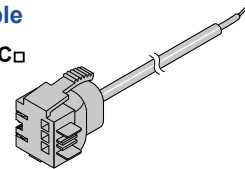

End plates End plates are not supplied with the amplifier. Please order them separately when the amplifiers are mounted in cascade.

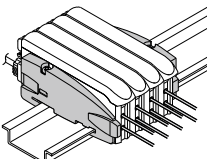
Appearance	Model No.	Description
	MS-DIN-E	When amplifiers are mounted in cascade, or when an amplifier moves depending on the way it is installed on a DIN rail, these end plates clamp amplifiers into place on both sides. Make sure to use end plates when cascading multiple amplifiers together. 2 pcs. per set

OPTIONS

Designation	Model No.	Description
Amplifier mounting bracket	MS-DIN-2	Mounting bracket for amplifier
Fiber amplifier protection seal	FX-MB1	10 sets of 2 communication window seals and 1 connector seal Communication window seal: It prevents malfunction due to transmission signal from another amplifier, as well as, prevents effect on another amplifier. Connector seal: It prevents contact of any metal, etc., with the pins of the quick-connection cable.

Amplifier mounting bracket

- **MS-DIN-2**

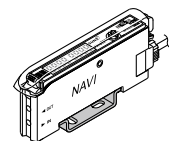

Fiber amplifier protection seal

- **FX-MB1**

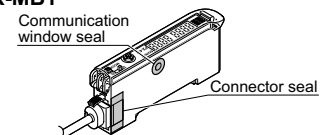

LIST OF FIBERS

Thru-beam type (one pair set)



Fibers are listed in alphabetic order.

Model No.	Sensing range (mm in) (Note 1)									Dimensions
	Red LED			Blue LED			Green LED			
	U-LG	STD	FAST	U-LG	STD	FAST	U-LG	STD	FAST	
FT-140	19,600 771.654 (Note 2)	16,000 629.921	15,000 590.551	14,000 551.181	3,300 129.921	2,200 86.614	9,500 374.016	2,500 98.425	1,800 70.866	P.63
FT-30	600 23.622	145 5.709	95 3.740	90 3.543	24 0.945	15 0.591	45 1.772	12 0.472	8 0.315	P.63
FT-31	540 21.260	140 5.512	85 3.346	85 3.346	20 0.787	14 0.551	38 1.496	10 0.394	7 0.276	P.63
FT-31S	540 21.260	140 5.512	85 3.346	85 3.346	20 0.787	14 0.551	38 1.496	10 0.394	7 0.276	P.63
FT-31W	380 14.961	80 3.150	55 2.165	53 2.087	16 0.630	9 0.354	28 1.102	7 0.276	4 0.157	P.63
FT-32	3,600 141.732 (Note 2)	1,190 46.850	870 34.252	860 33.858	220 8.661	145 5.709	450 17.717	120 4.724	80 3.150	P.63
FT-40	1,600 62.922	345 13.583	245 9.646	250 9.843	65 2.559	45 1.772	140 5.512	40 1.575	25 0.984	P.63
FT-42	1,550 61.024	340 13.386	240 9.449	230 9.055	60 2.362	40 1.575	125 4.921	33 1.299	22 0.866	P.63
FT-42S	1,550 61.024	340 13.386	240 9.449	230 9.055	60 2.362	40 1.575	125 4.921	33 1.299	22 0.866	P.63
FT-42W	1,300 51.181	290 11.417	210 8.268	220 8.661	57 2.244	33 1.299	110 4.331	32 1.260	19 0.748	P.63
FT-43	2,200 86.614	450 17.717	310 12.205	460 18.110	120 4.724	75 2.953	250 9.843	62 2.441	44 1.732	P.64
FT-45X	1,600 62.992	370 14.567	280 11.024	260 10.236	64 2.520	45 1.772	130 5.118	34 1.339	23 0.906	P.64
FT-A11	3,600 141.732 (Note 2)	2,400 94.488	1,800 70.866	1,300 51.181	350 13.780	220 8.661	770 30.315	190 7.480	120 4.724	P.64
FT-A11W	3,600 141.732 (Note 2)	2,500 98.425	2,000 78.740	1,300 51.181	350 13.780	220 8.661	550 21.654	150 5.906	130 5.118	P.64
FT-A32	3,600 141.732 (Note 2)	3,600 141.732 (Note 2)	3,600 141.732 (Note 2)	2,500 98.425	750 29.528	380 14.961	1,500 59.055	220 8.661	130 5.118	P.64
FT-A32W	3,600 141.732 (Note 2)	3,600 141.732 (Note 2)	3,600 141.732 (Note 2)	3,400 133.858	800 31.496	470 18.504	2,100 82.677	330 12.992	140 5.512	P.64
FT-AL05	1,100 43.307	240 9.449	180 7.087	220 8.661	55 2.165	35 1.378	125 4.921	30 1.181	20 0.787	P.64
FT-E13	30 1.181	7 0.276	5 0.197	2.5 0.098	—	—	1 0.039	—	—	P.64
FT-E23	110 4.331	20 0.787	15 0.591	12 0.472	3 0.118	2 0.079	6 0.236	1 0.039	—	P.64
FT-H13-FM2	1,100 43.307	280 11.024	200 7.874	50 1.969	13 0.512	9 0.354	150 5.906	16 0.630	10 0.394	P.65
FT-H20-J20-S (Note 3)	700 27.559	160 6.299	110 4.331	120 4.724	20 0.787	—	60 2.362	—	—	P.65
FT-H20-J30-S (Note 3)	700 27.559	160 6.299	110 4.331	120 4.724	20 0.787	—	60 2.362	—	—	P.65
FT-H20-J50-S (Note 3)	700 27.559	160 6.299	110 4.331	120 4.724	20 0.787	—	60 2.362	—	—	P.65
FT-H20-M1	550 21.654	150 5.906	100 3.937	100 3.937	25 0.984	20 0.787	65 2.559	17 0.669	12 0.472	P.65
FT-H20-VJ50-S (Note 3)	1,100 43.307	240 9.449	170 6.693	170 6.693	35 1.378	—	90 3.543	—	—	P.65
FT-H20-VJ80-S (Note 3)	1,100 43.307	240 9.449	170 6.693	170 6.693	35 1.378	—	90 3.543	—	—	P.65
FT-H20W-M1	400 15.748	110 4.331	80 3.15	75 2.953	19 0.748	13 0.512	58 2.283	13 0.512	9 0.354	P.65
FT-H30-M1V-S (Note 4)	390 15.354	100 3.937	70 2.756	75 2.953	20 0.787	15 0.591	55 2.165	13 0.512	10 0.394	P.65
FT-H35-M2	600 23.622	150 5.906	110 4.331	115 4.528	28 1.102	20 0.787	90 3.543	20 0.787	14 0.551	P.65
FT-H35-M2S6	600 23.622	150 5.906	110 4.331	115 4.528	28 1.102	20 0.787	90 3.543	20 0.787	14 0.551	P.65
FT-HL80Y	3,500 137.795 (Note 2)	800 31.496	550 21.654	150 5.906	35 1.378	20 0.787	200 7.874	55 2.165	35 1.378	P.66
FT-KS40	3,600 141.732 (Note 2)	2,000 78.740	1,900 74.803	1,000 39.370	270 10.630	190 7.480	590 23.228	130 5.118	53 2.087	P.66
FT-KV26	880 34.646	170 6.693	120 4.724	130 5.118	31 1.220	—	90 3.543	18 0.709	—	P.66
FT-KV26H1	790 31.102	150 5.906	100 3.937	115 4.528	28 1.102	—	80 3.150	16 0.630	—	P.66
FT-KV40	3,600 141.732 (Note 2)	1,700 66.929	1,300 51.181	1,200 47.244	310 12.205	190 7.480	800 31.496	190 7.480	120 4.724	P.66
FT-KV40W	3,600 141.732 (Note 2)	1,600 62.992	1,100 43.307	900 35.433	270 10.630	140 5.512	420 16.535	100 3.937	65 2.559	P.66
FT-L80Y	3,500 137.795 (Note 2)	900 35.433	600 23.622	250 9.843	60 2.362	40 1.575	300 11.811	70 2.756	45 1.772	P.66
FT-R31	380 14.961	79 3.110	56 2.205	80 3.150	20 0.787	13 0.512	38 1.496	10 0.394	7 0.276	P.66
FT-R40	1,200 47.244	240 9.449	170 6.693	200 7.874	50 1.969	32 1.260	100 3.937	28 1.102	19 0.748	P.66
FT-R41W	1,200 47.244	290 11.417	200 7.874	220 8.661	57 2.244	33 1.299	100 3.937	26 1.024	18 0.709	P.66
FT-R42W	3,600 141.732 (Note 2)	990 38.976	740 29.134	310 12.205	75 2.953	58 2.283	270 10.630	70 2.756	50 1.969	P.66
FT-R43	1,200 47.244	230 9.055	160 6.299	200 7.874	50 1.969	32 1.260	100 3.937	26 1.024	18 0.709	P.67
FT-R44Y	1,200 47.244	230 9.055	160 6.299	200 7.874	50 1.969	32 1.260	100 3.937	26 1.024	18 0.709	P.67
FT-R60Y	3,600 141.732 (Note 2)	750 29.528	540 21.260	560 22.047	140 5.512	90 3.543	290 11.417	75 2.953	50 1.969	P.67
FT-S11	150 5.906	30 1.181	20 0.787	21 0.827	5 0.197	3.5 0.138	12 0.472	2 0.079	1.5 0.059	P.67
FT-S20	600 23.622	145 5.709	95 3.740	90 3.543	24 0.945	15 0.591	45 1.772	12 0.472	8 0.315	P.67
FT-S21	540 21.260	140 5.512	85 3.346	85 3.346	20 0.787	14 0.551	38 1.496	10 0.394	7 0.276	P.67

Notes: 1) Note that the sensing range of the free-cut type fiber may be reduced by 20 % max. depending upon how the fiber is cut.

2) The fiber cable length practically limits the sensing range.

3) Heat-resistant joint fibers and ordinary-temperature fibers (**FT-42**) are sold as a set.

4) Sold as a set comprising vacuum type fiber + photo-terminal (**FV-BR1**) + fiber at atmospheric side (**FT-J8**).

LIST OF FIBERS

Thru-beam type (one pair set)



Fibers are listed in alphabetic order.

Model No.	Sensing range (mm in) (Note 1)									Dimensions
	Red LED			Blue LED			Green LED			
	U-LG	STD	FAST	U-LG	STD	FAST	U-LG	STD	FAST	
FT-S21W	380 14.961	80 3.150	55 2.165	53 2.087	16 0.630	9 0.354	28 1.102	7 0.276	4 0.157	P.67
FT-S22	910 35.827	190 7.480	140 5.512	110 4.331	29 1.142	17 0.669	70 2.756	18 0.709	11 0.433	P.67
FT-S30	1,600 62.992	345 13.583	245 9.646	250 9.843	65 2.559	45 1.772	140 5.512	40 1.575	25 0.984	P.67
FT-S31W	1,300 51.181	290 11.417	210 8.268	220 8.661	57 2.244	33 1.299	110 4.331	32 1.260	19 0.748	P.68
FT-S32	3,600 141.732 (Note 2)	920 36.220	670 26.378	700 27.559	180 7.087	110 4.331	400 15.748	92 3.622	62 2.441	P.68
FT-V23	720 28.346	140 5.512	100 3.937	120 4.724	30 1.181	20 0.787	65 2.559	16 0.630	9 0.354	P.68
FT-V24W	140 5.512	25 0.984	20 0.787	18 0.709	2 0.079	—	5 0.197	—	—	P.68
FT-V25	360 14.173	70 2.756	50 1.969	57 2.244	10 0.394	7 0.276	28 1.102	8 0.315	5 0.197	P.68
FT-V30	770 30.315	160 6.299	120 4.724	210 8.268	47 1.850	28 1.102	100 3.937	22 0.866	10 0.394	P.68
FT-V40	3,600 141.732 (Note 2)	950 37.402	730 28.740	810 31.890	190 7.480	130 5.118	500 19.685	115 4.528	81 3.189	P.68
FT-V80Y	1,500 59.055	350 13.780	250 9.843	240 9.449	55 2.165	35 1.378	180 7.087	38 1.496	24 0.945	P.68
FT-Z20HBW	390 15.354	80 3.150	55 2.165	64 2.520	16 0.630	10 0.394	30 1.181	7 0.276	5 0.197	P.68
FT-Z20W	1,300 51.181	270 10.630	190 7.480	170 6.693	39 1.535	23 0.906	92 3.622	19 0.748	11 0.433	P.68
FT-Z30	3,100 122.047	660 25.984	480 18.898	640 25.197	160 6.299	100 3.937	320 12.598	87 3.425	59 2.323	P.68
FT-Z30E	3,600 141.732 (Note 2)	1,200 47.244	920 36.220	960 37.795	250 9.843	160 6.299	460 18.110	120 4.724	83 3.268	P.69
FT-Z30EW	3,600 141.732 (Note 2)	590 23.228	430 16.929	940 37.008	180 7.087	110 4.331	400 15.748	85 3.346	56 2.205	P.69
FT-Z30H	3,600 141.732 (Note 2)	1,300 51.181	950 37.402	1,100 43.307	290 11.417	170 6.693	580 22.835	150 5.906	100 3.937	P.69
FT-Z30HW	3,600 141.732 (Note 2)	1,300 51.181	950 37.402	940 37.008	180 7.087	110 4.331	400 15.748	85 3.346	56 2.205	P.69
FT-Z30W	2,400 94.488	540 21.260	390 15.354	490 19.291	120 4.724	83 3.268	240 9.449	67 2.638	45 1.772	P.69
FT-Z40HBW	1,300 51.181	290 11.417	210 8.268	220 8.661	57 2.244	33 1.299	110 4.331	32 1.260	19 0.748	P.69
FT-Z40W	2,200 86.614	460 18.110	340 13.386	380 14.961	90 3.543	63 2.480	170 6.693	45 1.772	30 1.181	P.69
FT-Z802Y	3,500 137.795 (Note 2)	750 29.528	540 21.260	450 17.717	110 4.331	80 3.150	300 11.811	80 3.150	60 2.362	P.69

Notes: 1) Note that the sensing range of the free-cut type fiber may be reduced by 20 % max. depending upon how the fiber is cut.

2) The fiber cable length practically limits the sensing range.

Retroreflective type



Fibers are listed in alphabetic order.

Model No.	Sensing range (mm in) (Note 1,2)									Dimensions
	Red LED			Blue LED			Green LED			
	U-LG	STD	FAST	U-LG	STD	FAST	U-LG	STD	FAST	
FR-KZ22E	15 to 350 0.591 to 13.780	15 to 140 0.591 to 5.512	15 to 100 0.591 to 3.937	20 to 100 0.787 to 3.937	—	—	—	—	—	P.70
FR-KZ50E	20 to 400 0.787 to 15.748	20 to 200 0.787 to 7.874	20 to 200 0.787 to 7.874	20 to 200 0.787 to 7.874	20 to 84 0.787 to 3.307	20 to 45 0.787 to 1.771	20 to 180 0.787 to 7.087	20 to 55 0.787 to 1.969	—	P.70
FR-KZ50H	20 to 400 0.787 to 15.748	20 to 200 0.787 to 7.874	20 to 200 0.787 to 7.874	20 to 145 0.787 to 5.709	20 to 47 0.787 to 1.850	20 to 26 0.787 to 1.024	20 to 145 0.787 to 5.709	20 to 47 0.787 to 1.850	20 to 26 0.787 to 1.024	P.70
FR-Z50HW	100 to 1,000 3.937 to 39.370	100 to 540 3.937 to 21.260	100 to 460 3.937 to 18.110	100 to 490 3.937 to 19.291	—	—	—	—	—	P.70

Notes: 1) Note that the sensing range of the free-cut type fiber may be reduced by 20 % max. depending upon how the fiber is cut.

The sensing range of **FR-KZ22E** is specified for the attached reflector. The sensing range of **FR-KZ50E** and **FR-KZ50H** is specified for the attached reflector **RF-003**. The sensing range of **FR-Z50HW** is specified for the reflective tape **RF-13**.

2) The sensing range is the possible setting range for the attached reflector. The fiber can detect an object less than setting range for the reflector.

However, note that if there are any white or highly-reflective surfaces near the fiber head, reflected incident light may affect the fiber head. If this occurs, adjust the threshold value of the amplifier unit before use.

Sensing range when using in combination with FR-Z50HW reflector (Optional)

The sensing ranges are the value for red LED types.

Reflector Model No.	Sensing range (mm in)		
	FX-411		
	U-LG	STD	FAST
RF-230	100 to 12,000 3.937 to 47.244	100 to 1,700 3.937 to 66.929	100 to 1,300 3.937 to 51.181
RF-220	100 to 2,200 3.937 to 8.661	100 to 950 3.937 to 37.402	100 to 730 3.937 to 28.740
RF-210	100 to 2,100 3.937 to 82.677	100 to 780 3.937 to 30.709	100 to 620 3.937 to 24.409

Note: The sensing range is the possible setting range for the reflector. The fiber can detect an object less than setting range for the reflector. However, note that if there are any white or highly-reflective surfaces near the fiber head, reflected incident light may affect the fiber head. If this occurs, adjust the threshold value of the amplifier unit before use.

LIST OF FIBERS

Reflective type



Fibers are listed in alphabetic order.

Model No.	Sensing range (mm in) (Note 1, 2) / Description										Dimensions								
	Red LED			Blue LED			Green LED												
	U-LG	STD	FAST	U-LG	STD	FAST	U-LG	STD	FAST										
FD-30	200	7.874	48	1.890	35	1.378	40	1.575	9	0.354	6	0.236	18	0.709	5	0.197	3	0.118	P.71
FD-31	175	6.890	45	1.772	34	1.339	35	1.378	8	0.315	5	0.197	16	0.630	4	0.157	2	0.079	P.71
FD-31W	120	4.724	20	0.787	15	0.591	16	0.630	3	0.118	1 to 2.5	0.039 to 0.098	7	0.276	1 to 2.5	0.039 to 0.098	—	P.71	
FD-32G	240	9.449	52	2.047	38	1.496	48	1.890	11	0.433	8	0.315	24	0.945	5	0.197	4	0.157	P.71
FD-32GX	320	12.598	50	1.969	38	1.496	50	1.969	12	0.472	9	0.354	24	0.945	7	0.276	4	0.157	P.71
FD-34G	150	5.906	30	1.181	22	0.866	19	0.748	5	0.197	0.2 to 3	0.008 to 0.118	10	0.394	0.3 to 2.5	0.012 to 0.098	0.4 to 1.5	0.016 to 0.059	P.71
FD-40	200	7.874	48	1.890	35	1.378	40	1.575	9	0.354	6	0.236	18	0.709	5	0.197	3	0.118	P.71
FD-41	175	6.890	45	1.772	34	1.339	35	1.378	8	0.315	5	0.197	16	0.630	4	0.157	2	0.079	P.71
FD-41S	175	6.890	40	1.575	30	1.181	35	1.378	8	0.315	5	0.197	16	0.630	4	0.157	2	0.079	P.71
FD-41SW	120	4.724	20	0.787	15	0.591	18	0.709	1 to 4	0.039 to 0.157	1 to 2.5	0.039 to 0.098	12	0.472	1 to 2.5	0.039 to 0.098	—	P.71	
FD-41W	330	12.992	70	2.756	50	1.969	54	2.126	0.5 to 13	0.020 to 0.512	1 to 8	0.039 to 0.315	29	1.142	1.5 to 7	0.059 to 0.276	1.5 to 4.5	0.059 to 0.177	P.72
FD-42G	240	9.449	52	2.047	38	1.496	48	1.890	11	0.433	8	0.315	24	0.945	5	0.197	4	0.157	P.72
FD-42GW	240	9.449	40	1.575	30	1.181	30	1.181	7	0.276	5	0.197	15	0.591	4	0.157	2	0.079	P.72
FD-60	600	23.622	150	5.906	100	3.937	130	5.118	30	1.181	20	0.787	70	2.756	20	0.787	13	0.512	P.72
FD-61	510	20.079	140	5.512	90	3.543	105	4.134	27	1.063	18	0.709	65	2.559	16	0.630	11	0.433	P.72
FD-61G	460	18.110	110	4.331	80	3.150	105	4.134	27	1.063	18	0.709	55	2.165	15	0.591	9	0.354	P.72
FD-61S	500	19.685	140	5.512	95	3.740	105	4.134	27	1.063	18	0.709	65	2.559	16	0.630	11	0.433	P.72
FD-61W	330	12.992	70	2.756	50	1.969	54	2.126	0.5 to 13	0.020 to 0.512	1 to 8	0.039 to 0.315	29	1.142	1.5 to 7	0.059 to 0.276	1.5 to 4.5	0.059 to 0.177	P.73
FD-62	820	32.283	180	7.087	130	5.118	160	6.299	1 to 44	0.039 to 1.732	1 to 29	0.039 to 1.142	98	3.858	1 to 26	0.039 to 1.024	1 to 18	0.039 to 0.709	P.73
FD-64X	380	14.961	80	3.150	55	2.165	54	2.126	0.5 to 14	0.020 to 0.551	0.5 to 9	0.020 to 0.354	27	1.063	0.5 to 7	0.020 to 0.276	0.5 to 4.5	0.020 to 0.177	P.73
FD-A16	200	7.874	100	3.937	75	2.953	30	1.181	13	0.512	13	0.512	57	2.244	14	0.551	—	P.73	
FD-AL11	460	18.110	100	3.937	70	2.756	70	2.756	17	0.669	10	0.394	45	1.772	9	0.354	6	0.236	P.73
FD-E13	20	0.787	4	0.157	3	0.118	2.5	0.098	0.7	0.028	—	—	1.5	0.059	—	—	—	P.73	
FD-E23	75	2.953	15	0.591	10	0.394	10	0.394	2.5	0.098	1.5	0.059	5	0.197	1.3	0.051	0.9	0.035	P.73
FD-EG30	90	3.543	15	0.591	10	0.394	10	0.394	2.5	0.098	1.5	0.059	5	0.197	1.3	0.051	0.9	0.035	P.73
FD-EG30S	85	3.346	15	0.591	10	0.394	10	0.394	2.5	0.098	1.5	0.059	5	0.197	1.3	0.051	0.9	0.035	P.74
FD-EG31	25	0.984	5	0.197	4	0.157	4	0.157	1	0.039	0.5	0.020	2	0.079	—	—	—	P.74	
FD-F4	Applicable pipe diameter: Outer dia. $\phi 6$ to $\phi 26$ mm $\phi 0.236$ to $\phi 1.024$ in transparent pipe [PFA (fluorine resin) or equivalently transparent pipe, wall thickness 1 mm 0.039 in] Liquid absent: Beam received, Liquid present: Beam not received										P.74								
FD-F41	Applicable pipe diameter: Outer dia. $\phi 6$ to $\phi 26$ mm $\phi 0.236$ to $\phi 1.024$ in transparent pipe [PVC (vinyl chloride), fluorine resin, polycarbonate, acrylic, glass, wall thickness 1 to 3 mm 0.039 to 0.118 in] Liquid absent: Beam received, Liquid present: Beam not received										P.74								
FD-F41Y	$\phi 4$ mm $\phi 0.157$ in Protective tube: Fluorine resin, length 500 mm 19.685 in (cuttable) Liquid surface not contacted: Beam received, Liquid surface contacted: Beam not received										P.74								
FD-F8Y	—	—	—	—	—	—	—	—	—	—	—	—	—	—	—	—	—	—	P.74
FD-FA93	Applicable pipe diameter: Outer dia. $\phi 8$ mm $\phi 0.315$ in or more transparent pipe (When used with the tying bands: $\phi 8$ to $\phi 80$ mm $\phi 0.315$ to $\phi 3.150$ in) [PFA (fluorine resin), including translucent] Liquid absent: Beam received, Liquid present: Beam not received										P.74								
FD-H13-FM2	430	16.929	100	3.937	70	2.756	40	1.575	10	0.394	7	0.276	40	1.575	10	0.394	7	0.276	P.75
FD-H18-L31	0 to 25	0 to 0.984	0 to 10	0 to 0.394	0 to 8	0 to 0.315	—	—	—	—	—	—	—	—	—	—	—	—	P.75
FD-H20-21	350	13.780	90	3.543	65	2.559	65	2.559	13	0.512	9	0.354	45	1.772	10	0.394	7	0.276	P.75
FD-H20-M1	270	10.630	85	3.346	60	2.362	60	2.362	14	0.551	10	0.394	58	2.283	10	0.394	7	0.276	P.75
FD-H25-L43	2.5 to 29	0.098 to 1.142	4 to 20	0.157 to 0.787	4 to 16	0.157 to 0.630	—	—	—	—	—	—	—	—	—	—	—	—	P.75
FD-H25-L45	5 to 42	0.197 to 1.654	7 to 38	0.276 to 1.496	7 to 35	0.276 to 1.437	—	—	—	—	—	—	—	—	—	—	—	—	P.75

Notes: 1) The standard sensing objects of the sensing ranges vary depending on the fibers.

2) Note that the sensing range of the free-cut type fiber may be reduced by 20 % max. depending upon how the fiber is cut.

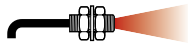
LIST OF FIBERS**Reflective type**

Fibers are listed in alphabetic order.

Model No.	Sensing range (mm in) (Note 1, 2) / Description									Dimensions
	Red LED			Blue LED			Green LED			
	U-LG	STD	FAST	U-LG	STD	FAST	U-LG	STD	FAST	
FD-H30-KZ1V-S (Note 3)	20 to 300 0.787 to 11.811	25 to 100 0.984 to 3.937	25 to 45 0.984 to 1.772	—	—	—	—	—	—	P.76
FD-H30-L32	0 to 20 0 to 0.787	1 to 8 0.039 to 0.315	1 to 6 0.039 to 0.236	—	—	—	—	—	—	P.76
FD-H30-L32V-S (Note 3)	0 to 11 0 to 0.433	1.5 to 5 0.059 to 0.197	2 to 4 0.079 to 0.157	—	—	—	—	—	—	P.76
FD-H35-20S	210 8.268	50 1.969	35 1.378	45 1.772	10 0.394	7 0.276	20 0.787	6 0.236	4 0.157	P.76
FD-H35-M2	300 11.811	83 3.268	60 2.362	50 1.969	12 0.472	9 0.354	50 1.969	10 0.394	7 0.276	P.76
FD-H35-M2S6	300 11.811	80 3.150	50 1.969	50 1.969	14 0.551	10 0.394	40 1.575	10 0.394	7 0.276	P.76
FD-HF40Y	ø4 mm ø0.157 in Protective tube: fluorine resin, length:500 mm 19.685 in (allowable cutting) Liquid surface not contacted: Beam received, Liquid surface contacted: Beam not received									P.76
FD-L10	0 to 4.4 0 to 0.173	0 to 4 0 to 0.157	0 to 3.8 0 to 0.150	3.5 0.138	2.5 0.098	2 0.079	0 to 3 0 to 0.118	1 to 2 0.039 to 0.079	—	P.77
FD-L11	0 to 10 0 to 0.394	0 to 7 0 to 0.276	0 to 7 0 to 0.276	8.5 0.335	6 0.236	5.5 0.217	8 0.315	5 0.197	—	P.77
FD-L12W	0.5 to 10 0.020 to 0.394	1 to 4.5 0.039 to 0.177	1 to 3.5 0.039 to 0.137	—	—	—	—	—	—	P.77
FD-L20H	1 to 32 0.039 to 1.260	4 to 10 0.157 to 0.394	4.5 to 10 0.177 to 0.394	4 to 13 0.157 to 0.512	5 to 9 0.197 to 0.354	5.5 to 8.5 0.217 to 0.334	5 to 11 0.197 to 0.433	6 to 8.5 0.236 to 0.335	—	P.77
FD-L21	1 to 18 0.039 to 0.709	3 to 14 0.118 to 0.551	3 to 13 0.118 to 0.512	—	—	—	—	—	—	P.77
FD-L21W	3 to 16 0.118 to 0.630	7 to 12 0.276 to 0.472	7 to 11 0.276 to 0.433	—	—	—	—	—	—	P.77
FD-L22A	0 to 26 0 to 1.024	0 to 23 0 to 0.906	0 to 19 0 to 0.748	—	—	—	—	—	—	P.77
FD-L23	0 to 30 0 to 1.181	0 to 30 0 to 1.181	0 to 28 0 to 1.102	—	—	—	—	—	—	P.77
FD-L30A	0 to 50 0 to 1.969	0 to 36 0 to 1.417	0 to 30 0 to 1.181	—	—	—	—	—	—	P.77
FD-L31A	4 to 33 0.157 to 1.299	5 to 32 0.197 to 1.260	5 to 30 0.197 to 1.181	4 to 31 0.157 to 1.220	—	—	—	—	—	P.77
FD-L32H	0 to 65 0 to 2.559	15 to 30 0.591 to 1.181	20 to 25 0.787 to 0.984	15 to 30 0.591 to 1.181	—	—	—	—	—	P.78
FD-R31G	240 9.449	42 1.654	30 1.181	41 1.614	9 0.354	6 0.236	21 0.827	5 0.197	2 0.079	P.78
FD-R32EG	90 3.543	15 0.591	10 0.394	10 0.394	2.5 0.098	1.5 0.059	5 0.197	1.3 0.051	—	P.78
FD-R33EG	25 0.984	5 0.197	3 0.118	4 0.157	0.8 0.031	—	2 0.079	—	—	P.78
FD-R34EG	75 2.953	13 0.512	8 0.315	9 0.354	2 0.079	1 0.039	5 0.197	0.9 0.035	—	P.78
FD-R41	330 12.992	65 2.559	47 1.850	51 2.008	10 0.394	1 to 8 0.039 to 0.315	25 0.984	1 to 6 0.039 to 0.236	1 to 5 0.039 to 0.197	P.78
FD-R60	420 16.535	110 4.331	80 3.150	82 3.228	23 0.906	15 0.591	59 2.323	15 0.591	10 0.394	P.78
FD-R61Y	340 13.386	65 2.559	47 1.850	60 2.362	0.5 to 15 0.020 to 0.591	0.5 to 10 0.020 to 0.394	30 1.181	0.5 to 7 0.020 to 0.276	1 to 5 0.039 to 0.197	P.78
FD-S21	80 3.150	18 0.709	13 0.512	12 0.472	2.5 0.098	2 0.079	6.5 0.256	1.5 0.059	1 0.039	P.78
FD-S30	200 7.874	48 0.890	35 1.378	40 1.575	9 0.354	6 0.236	18 0.709	5 0.197	3 0.118	P.79
FD-S31	175 6.890	45 1.772	34 1.339	35 1.378	8 0.315	5 0.197	16 0.630	4 0.157	2 0.079	P.79
FD-S32	510 20.079	120 4.724	90 3.543	105 4.134	27 1.063	18 0.709	65 2.559	16 0.630	11 0.433	P.79
FD-S32W	330 12.992	70 2.756	50 1.969	54 2.126	0.5 to 13 0.020 to 0.512	1 to 8 0.039 to 0.315	29 1.142	1.5 to 7 0.059 to 0.276	1.5 to 4.5 0.059 to 0.177	P.79
FD-S33GW	240 9.449	40 1.575	30 1.181	30 1.181	7 0.276	5 0.197	15 0.591	4 0.157	2 0.079	P.79
FD-S34G	150 5.906	30 1.181	22 0.866	19 0.748	5 0.197	0.2 to 3 0.008 to 0.118	10 0.394	0.3 to 2.5 0.012 to 0.098	0.4 to 1.5 0.016 to 0.059	P.79
FD-S60Y	410 16.142	130 5.118	100 3.937	120 4.724	25 0.984	17 0.669	65 2.559	10 0.394	—	P.79
FD-V30	110 4.331	19 0.748	14 0.551	18 0.709	—	—	10 0.394	—	—	P.79
FD-V30W	30 1.181	5 0.197	3 0.118	—	—	—	—	—	—	P.80
FD-V50	160 6.299	35 1.378	25 0.984	27 1.063	7 0.276	—	16 0.630	—	—	P.80
FD-Z20HBW	1 to 100 0.039 to 3.937	3 to 20 0.118 to 0.787	3 to 15 0.118 to 0.591	3 to 16 0.118 to 0.630	—	—	3 to 8 0.118 to 0.315	—	—	P.80
FD-Z20W	140 5.512	3 to 26 0.118 to 1.024	3 to 17 0.118 to 0.669	4 to 12 0.157 to 0.472	—	—	—	—	—	P.80
FD-Z40HBW	420 16.535	1 to 80 0.039 to 3.150	1 to 60 0.039 to 2.362	1 to 89 0.039 to 3.504	3 to 20 1.181 to 0.787	3 to 13 1.181 to 0.512	1 to 42 0.039 to 1.654	3 to 11 0.118 to 0.433	3 to 7 0.118 to 0.276	P.80
FD-Z40W	340 13.386	1 to 67 0.039 to 2.638	1 to 48 0.039 to 1.890	1 to 55 0.039 to 2.165	5 to 10 0.197 to 0.394	—	3 to 25 0.118 to 0.984	—	—	P.80
FD-Z50HW	10 to 890 0.394 to 35.039	15 to 210 0.591 to 8.268	15 to 160 0.591 to 6.299	20 to 100 0.787 to 3.937	—	—	20 to 55 0.787 to 2.165	—	—	P.80

Notes: 1) The standard sensing objects of the sensing ranges vary depending on the fibers.

2) Note that the sensing range of the free-cut type fiber may be reduced by 20 % max. depending upon how the fiber is cut.

3) Sold as a set comprising vacuum type fiber + photo-terminal (FV-BR1) + fiber at atmospheric side (FT-J8).

FIBER OPTIONS

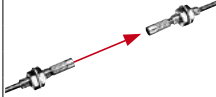
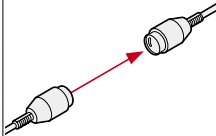
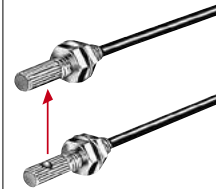
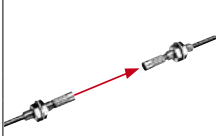
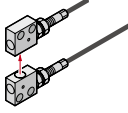

Lens (For thru-beam type fiber)

Designation	Model No.	Description																																													
For thru-beam type fiber	Expansion lens (Note 1)	FX-LE1	 <p>Increases the sensing range by 5 times or more.</p> <ul style="list-style-type: none"> Ambient temperature: -60 to +350 °C -76 to +662 °F (Note 5) Beam dia: ø3.6 mm ø0.142 in 																																												
			<p>Sensing range for red LED type (mm in) [Lens on both sides] (Note 2)</p> <table border="1"> <thead> <tr> <th>Fiber \ Mode</th> <th>U-LG</th> <th>STD</th> <th>FAST</th> </tr> </thead> <tbody> <tr> <td>FT-43</td> <td>3,600 141.732 (Note 3)</td> <td>2,300 90.551</td> <td>1,700 66.929</td> </tr> <tr> <td>FT-42</td> <td>3,600 141.732 (Note 3)</td> <td>3,200 125.984</td> <td>2,300 90.551</td> </tr> <tr> <td>FT-42W</td> <td>3,600 141.732 (Note 3)</td> <td>3,600 141.732 (Note 3)</td> <td>2,600 102.362</td> </tr> <tr> <td>FT-45X</td> <td>1,600 62.992 (Note 3)</td> <td>1,600 62.992 (Note 3)</td> <td>1,600 62.992 (Note 3)</td> </tr> <tr> <td>FT-R40</td> <td>3,600 141.732 (Note 3)</td> <td>2,900 114.173</td> <td>2,300 90.551</td> </tr> <tr> <td>FT-R43</td> <td>3,600 141.732 (Note 3)</td> <td>2,600 102.362</td> <td>1,900 74.803</td> </tr> <tr> <td>FT-R44Y</td> <td>3,600 141.732 (Note 3)</td> <td>2,600 102.362</td> <td>1,900 74.803</td> </tr> <tr> <td>FT-H35-M2</td> <td>3,500 137.795 (Note 3)</td> <td>1,100 43.307</td> <td>800 31.496</td> </tr> <tr> <td>FT-H20W-M1</td> <td>1,600 62.992 (Note 3)</td> <td>1,200 47.244</td> <td>800 31.496</td> </tr> <tr> <td>FT-H20-M1</td> <td>1,600 62.992 (Note 3)</td> <td>800 31.496</td> <td>600 23.622</td> </tr> </tbody> </table>	Fiber \ Mode	U-LG	STD	FAST	FT-43	3,600 141.732 (Note 3)	2,300 90.551	1,700 66.929	FT-42	3,600 141.732 (Note 3)	3,200 125.984	2,300 90.551	FT-42W	3,600 141.732 (Note 3)	3,600 141.732 (Note 3)	2,600 102.362	FT-45X	1,600 62.992 (Note 3)	1,600 62.992 (Note 3)	1,600 62.992 (Note 3)	FT-R40	3,600 141.732 (Note 3)	2,900 114.173	2,300 90.551	FT-R43	3,600 141.732 (Note 3)	2,600 102.362	1,900 74.803	FT-R44Y	3,600 141.732 (Note 3)	2,600 102.362	1,900 74.803	FT-H35-M2	3,500 137.795 (Note 3)	1,100 43.307	800 31.496	FT-H20W-M1	1,600 62.992 (Note 3)	1,200 47.244	800 31.496	FT-H20-M1	1,600 62.992 (Note 3)	800 31.496	600 23.622
	Fiber \ Mode	U-LG	STD	FAST																																											
	FT-43	3,600 141.732 (Note 3)	2,300 90.551	1,700 66.929																																											
	FT-42	3,600 141.732 (Note 3)	3,200 125.984	2,300 90.551																																											
FT-42W	3,600 141.732 (Note 3)	3,600 141.732 (Note 3)	2,600 102.362																																												
FT-45X	1,600 62.992 (Note 3)	1,600 62.992 (Note 3)	1,600 62.992 (Note 3)																																												
FT-R40	3,600 141.732 (Note 3)	2,900 114.173	2,300 90.551																																												
FT-R43	3,600 141.732 (Note 3)	2,600 102.362	1,900 74.803																																												
FT-R44Y	3,600 141.732 (Note 3)	2,600 102.362	1,900 74.803																																												
FT-H35-M2	3,500 137.795 (Note 3)	1,100 43.307	800 31.496																																												
FT-H20W-M1	1,600 62.992 (Note 3)	1,200 47.244	800 31.496																																												
FT-H20-M1	1,600 62.992 (Note 3)	800 31.496	600 23.622																																												
Super-expansion lens (Note 1)	FX-LE2	 <p>Tremendously increases the sensing range with large diameter lenses.</p> <ul style="list-style-type: none"> Ambient temperature: -60 to +350 °C -76 to +662 °F (Note 5) Beam dia: ø9.8 mm ø0.386 in 																																													
Side-view lens	FX-SV1	 <p>Beam axis is bent by 90°.</p> <ul style="list-style-type: none"> Ambient temperature: -60 to +300 °C -76 to +572 °F (Note 5) Beam dia: ø2.8 mm ø0.110 in 																																													
Expansion lens for vacuum fiber (Note 1)	FV-LE1	 <p>Sensing range increases by 4 times or more.</p> <ul style="list-style-type: none"> Ambient temperature: -60 to +350 °C -76 to +662 °F (Note 5) Beam dia: ø3.6 mm ø0.142 in 																																													
Vacuum resistant side-view lens (Note 1)	FV-SV2	 <p>Beam axis is bent by 90°.</p> <ul style="list-style-type: none"> Ambient temperature: -60 to +300 °C -76 to +572 °F (Note 5) Beam dia: ø3.7 mm ø0.146 in 																																													

Notes: 1) Be careful sure to use it only after you have adjusted it sufficiently when installing the thru-beam type fiber equipped with the expansion lens, as the beam envelope becomes narrow and alignment is difficult.
 2) The sensing ranges are the values for red LED type amplifier. Please contact our office for details on sensing ranges for other types of amplifiers.
 3) The fiber cable length practically limits the sensing range.
 4) The fiber cable length for the **FT-H30-M1V-S** is 1 m 3.281 ft. The sensing ranges in U-LG mode take into account the length of the **FT-J8** atmospheric side fiber.
 5) Refer to "Fiber Selection" for the ambient temperatures of fibers to be used in combination.

FIBER OPTIONS

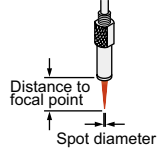
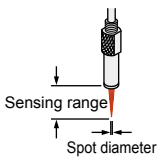
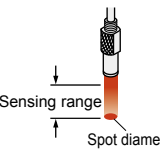
Lens (For reflective type fiber)

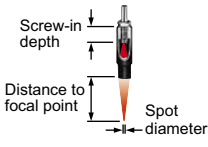
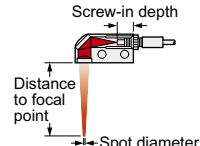
Designation	Model No.	Description																	
Pinpoint spot lens	FX-MR7		Extremely fine spot of $\phi 0.1$ mm $\phi 0.004$ in approx. achieved. <ul style="list-style-type: none"> Applicable fibers: FD-R33EG, FD-EG31, FD-R34EG, FD-R32EG, FD-EG30, FD-R31G, FD-42G, FD-42GW, FD-32G, FD-32GX Ambient temperature: -55 to $+70$ °C -67 to $+158$ °F (Note 2) 	Sensing range for red LED type (mm in) (Note 1) <table border="1"> <thead> <tr> <th>Fiber</th> <th>Distance to focal point</th> <th>Spot diameter</th> </tr> </thead> <tbody> <tr> <td>FD-R33EG FD-EG31</td> <td>7 ± 0.5 0.276 \pm 0.020</td> <td>$\phi 0.1$ $\phi 0.004$ approx.</td> </tr> <tr> <td>FD-R34EG</td> <td>7 ± 0.5 0.276 \pm 0.020</td> <td>$\phi 0.15$ $\phi 0.006$ approx.</td> </tr> <tr> <td>FD-R32EG FD-EG30</td> <td>7 ± 0.5 0.276 \pm 0.020</td> <td>$\phi 0.2$ $\phi 0.008$ approx.</td> </tr> <tr> <td>FD-R31G FD-42G/42GW FD-32G/32GX</td> <td>7 ± 0.5 0.276 \pm 0.020</td> <td>$\phi 0.4$ $\phi 0.016$ approx.</td> </tr> </tbody> </table>	Fiber	Distance to focal point	Spot diameter	FD-R33EG FD-EG31	7 ± 0.5 0.276 \pm 0.020	$\phi 0.1$ $\phi 0.004$ approx.	FD-R34EG	7 ± 0.5 0.276 \pm 0.020	$\phi 0.15$ $\phi 0.006$ approx.	FD-R32EG FD-EG30	7 ± 0.5 0.276 \pm 0.020	$\phi 0.2$ $\phi 0.008$ approx.	FD-R31G FD-42G/42GW FD-32G/32GX	7 ± 0.5 0.276 \pm 0.020	$\phi 0.4$ $\phi 0.016$ approx.
	Fiber		Distance to focal point	Spot diameter															
	FD-R33EG FD-EG31		7 ± 0.5 0.276 \pm 0.020	$\phi 0.1$ $\phi 0.004$ approx.															
FD-R34EG	7 ± 0.5 0.276 \pm 0.020	$\phi 0.15$ $\phi 0.006$ approx.																	
FD-R32EG FD-EG30	7 ± 0.5 0.276 \pm 0.020	$\phi 0.2$ $\phi 0.008$ approx.																	
FD-R31G FD-42G/42GW FD-32G/32GX	7 ± 0.5 0.276 \pm 0.020	$\phi 0.4$ $\phi 0.016$ approx.																	
FX-MR6	Extremely fine spot of $\phi 0.1$ mm $\phi 0.004$ in approx. achieved. <ul style="list-style-type: none"> Applicable fibers: FD-EG31, FD-EG30, FD-42G, FD-42GW, FD-32G, FD-32GX Ambient temperature: -20 to $+60$ °C -4 to $+140$ °F (Note 2) 	Sensing range for red LED type (mm in) (Note 1) <table border="1"> <thead> <tr> <th>Fiber</th> <th>Distance to focal point</th> <th>Spot diameter</th> </tr> </thead> <tbody> <tr> <td>FD-EG31</td> <td>7 ± 0.5 0.276 \pm 0.020</td> <td>$\phi 0.1$ $\phi 0.004$ approx.</td> </tr> <tr> <td>FD-EG30</td> <td>7 ± 0.5 0.276 \pm 0.020</td> <td>$\phi 0.2$ $\phi 0.008$ approx.</td> </tr> <tr> <td>FD-42G/42GW FD-32G/32GX</td> <td>7 ± 0.5 0.276 \pm 0.020</td> <td>$\phi 0.4$ $\phi 0.016$ approx.</td> </tr> </tbody> </table>	Fiber	Distance to focal point	Spot diameter	FD-EG31	7 ± 0.5 0.276 \pm 0.020	$\phi 0.1$ $\phi 0.004$ approx.	FD-EG30	7 ± 0.5 0.276 \pm 0.020	$\phi 0.2$ $\phi 0.008$ approx.	FD-42G/42GW FD-32G/32GX	7 ± 0.5 0.276 \pm 0.020	$\phi 0.4$ $\phi 0.016$ approx.					
Fiber	Distance to focal point	Spot diameter																	
FD-EG31	7 ± 0.5 0.276 \pm 0.020	$\phi 0.1$ $\phi 0.004$ approx.																	
FD-EG30	7 ± 0.5 0.276 \pm 0.020	$\phi 0.2$ $\phi 0.008$ approx.																	
FD-42G/42GW FD-32G/32GX	7 ± 0.5 0.276 \pm 0.020	$\phi 0.4$ $\phi 0.016$ approx.																	
FX-MR3	Extremely fine spot of $\phi 0.15$ mm $\phi 0.006$ in approx. achieved. <ul style="list-style-type: none"> Applicable fibers: FD-EG31, FD-EG30, FD-42G, FD-42GW, FD-32G, FD-32GX Ambient temperature: -40 to $+70$ °C -40 to $+158$ °F (Note 2) 	Sensing range for red LED type (mm in) (Note 1) <table border="1"> <thead> <tr> <th>Fiber</th> <th>Distance to focal point</th> <th>Spot diameter</th> </tr> </thead> <tbody> <tr> <td>FD-EG31</td> <td>7.5 ± 0.5 0.295 \pm 0.020</td> <td>$\phi 0.15$ $\phi 0.006$ approx.</td> </tr> <tr> <td>FD-EG30</td> <td>7.5 ± 0.5 0.295 \pm 0.020</td> <td>$\phi 0.3$ $\phi 0.012$ approx.</td> </tr> <tr> <td>FD-42G/42GW FD-32G/32GX</td> <td>7.5 ± 0.5 0.295 \pm 0.020</td> <td>$\phi 0.5$ $\phi 0.020$ approx.</td> </tr> </tbody> </table>	Fiber	Distance to focal point	Spot diameter	FD-EG31	7.5 ± 0.5 0.295 \pm 0.020	$\phi 0.15$ $\phi 0.006$ approx.	FD-EG30	7.5 ± 0.5 0.295 \pm 0.020	$\phi 0.3$ $\phi 0.012$ approx.	FD-42G/42GW FD-32G/32GX	7.5 ± 0.5 0.295 \pm 0.020	$\phi 0.5$ $\phi 0.020$ approx.					
Fiber	Distance to focal point	Spot diameter																	
FD-EG31	7.5 ± 0.5 0.295 \pm 0.020	$\phi 0.15$ $\phi 0.006$ approx.																	
FD-EG30	7.5 ± 0.5 0.295 \pm 0.020	$\phi 0.3$ $\phi 0.012$ approx.																	
FD-42G/42GW FD-32G/32GX	7.5 ± 0.5 0.295 \pm 0.020	$\phi 0.5$ $\phi 0.020$ approx.																	
Zoom lens	FX-MR8		The spot diameter is adjustable according to how much the fiber is screwed in. <ul style="list-style-type: none"> Applicable fibers: FD-R33EG, FD-EG31, FD-R34EG, FD-R32EG, FD-EG30, FD-R31G, FD-42G, FD-42GW, FD-32G, FD-32GX Ambient temperature: -55 to $+70$ °C -67 to $+158$ °F (Note 2) 	Sensing range for red LED type (mm in) (Note 1) <table border="1"> <thead> <tr> <th>Fiber</th> <th>Sensing range</th> <th>Spot diameter</th> </tr> </thead> <tbody> <tr> <td>FD-R33EG FD-EG31</td> <td>10 to 30 0.394 to 1.181</td> <td>$\phi 0.4$ to $\phi 2.0$ $\phi 0.016$ to $\phi 0.079$ approx.</td> </tr> <tr> <td>FD-R34EG</td> <td>10 to 30 0.394 to 1.181</td> <td>$\phi 0.4$ to $\phi 2.2$ $\phi 0.016$ to $\phi 0.087$ approx.</td> </tr> <tr> <td>FD-R32EG FD-EG30</td> <td>10 to 30 0.394 to 1.181</td> <td>$\phi 0.5$ to $\phi 2.5$ $\phi 0.020$ to $\phi 0.098$ approx.</td> </tr> <tr> <td>FD-R31G FD-42G/42GW FD-32G/32GX</td> <td>10 to 30 0.394 to 1.181</td> <td>$\phi 0.8$ to $\phi 3.5$ $\phi 0.031$ to $\phi 0.138$ approx.</td> </tr> </tbody> </table>	Fiber	Sensing range	Spot diameter	FD-R33EG FD-EG31	10 to 30 0.394 to 1.181	$\phi 0.4$ to $\phi 2.0$ $\phi 0.016$ to $\phi 0.079$ approx.	FD-R34EG	10 to 30 0.394 to 1.181	$\phi 0.4$ to $\phi 2.2$ $\phi 0.016$ to $\phi 0.087$ approx.	FD-R32EG FD-EG30	10 to 30 0.394 to 1.181	$\phi 0.5$ to $\phi 2.5$ $\phi 0.020$ to $\phi 0.098$ approx.	FD-R31G FD-42G/42GW FD-32G/32GX	10 to 30 0.394 to 1.181	$\phi 0.8$ to $\phi 3.5$ $\phi 0.031$ to $\phi 0.138$ approx.
Fiber	Sensing range	Spot diameter																	
FD-R33EG FD-EG31	10 to 30 0.394 to 1.181	$\phi 0.4$ to $\phi 2.0$ $\phi 0.016$ to $\phi 0.079$ approx.																	
FD-R34EG	10 to 30 0.394 to 1.181	$\phi 0.4$ to $\phi 2.2$ $\phi 0.016$ to $\phi 0.087$ approx.																	
FD-R32EG FD-EG30	10 to 30 0.394 to 1.181	$\phi 0.5$ to $\phi 2.5$ $\phi 0.020$ to $\phi 0.098$ approx.																	
FD-R31G FD-42G/42GW FD-32G/32GX	10 to 30 0.394 to 1.181	$\phi 0.8$ to $\phi 3.5$ $\phi 0.031$ to $\phi 0.138$ approx.																	
Parallel light lens	FX-MR9		Long-range parallel light <ul style="list-style-type: none"> Applicable fibers: FD-R33EG, FD-EG31, FD-R34EG, FD-R32EG, FD-EG30, FD-R31G, FD-42G, FD-42GW, FD-32G, FD-32GX Ambient temperature: -55 to $+70$ °C -67 to $+158$ °F (Note 2) 	Sensing range for red LED type (mm in) (Note 1) <table border="1"> <thead> <tr> <th>Fiber</th> <th>Sensing range</th> <th>Spot diameter</th> </tr> </thead> <tbody> <tr> <td>FD-R33EG FD-EG31</td> <td>0 to 30 0 to 1.181</td> <td>$\phi 4.0$ $\phi 0.016$ approx.</td> </tr> <tr> <td>FD-R34EG</td> <td>0 to 30 0 to 1.181</td> <td>$\phi 4.0$ $\phi 0.016$ approx.</td> </tr> <tr> <td>FD-R32EG FD-EG30</td> <td>0 to 30 0 to 1.181</td> <td>$\phi 4.0$ $\phi 0.016$ approx.</td> </tr> <tr> <td>FD-R31G FD-42G/42GW FD-32G/32GX</td> <td>0 to 30 0 to 1.181</td> <td>$\phi 4.0$ $\phi 0.016$ approx.</td> </tr> </tbody> </table>	Fiber	Sensing range	Spot diameter	FD-R33EG FD-EG31	0 to 30 0 to 1.181	$\phi 4.0$ $\phi 0.016$ approx.	FD-R34EG	0 to 30 0 to 1.181	$\phi 4.0$ $\phi 0.016$ approx.	FD-R32EG FD-EG30	0 to 30 0 to 1.181	$\phi 4.0$ $\phi 0.016$ approx.	FD-R31G FD-42G/42GW FD-32G/32GX	0 to 30 0 to 1.181	$\phi 4.0$ $\phi 0.016$ approx.
Fiber	Sensing range	Spot diameter																	
FD-R33EG FD-EG31	0 to 30 0 to 1.181	$\phi 4.0$ $\phi 0.016$ approx.																	
FD-R34EG	0 to 30 0 to 1.181	$\phi 4.0$ $\phi 0.016$ approx.																	
FD-R32EG FD-EG30	0 to 30 0 to 1.181	$\phi 4.0$ $\phi 0.016$ approx.																	
FD-R31G FD-42G/42GW FD-32G/32GX	0 to 30 0 to 1.181	$\phi 4.0$ $\phi 0.016$ approx.																	
Pinpoint spot lens	FX-MR1		Pinpoint spot of $\phi 0.5$ mm $\phi 0.020$ in. Enables detection of minute objects or small marks. <ul style="list-style-type: none"> Distance to focal point: 6 ± 1 mm 0.236 \pm 0.039 in Applicable fibers: FD-42G, FD-42GW Ambient temperature: -40 to $+70$ °C -40 to $+158$ °F (Note 2) 																
Zoom lens	FX-MR2		The spot diameter is adjustable from $\phi 0.7$ to $\phi 2$ mm $\phi 0.028$ to $\phi 0.079$ in according to how much the fiber is screwed in. <ul style="list-style-type: none"> Applicable fibers: FD-42G, FD-42GW Ambient temperature: -40 to $+70$ °C -40 to $+158$ °F (Note 1) Accessory: MS-EX3 (mounting bracket) 	Sensing range for red LED type (mm in) (Note 1) <table border="1"> <thead> <tr> <th>Screw-in depth</th> <th>Distance to focal point</th> <th>Spot diameter</th> </tr> </thead> <tbody> <tr> <td>7 0.276</td> <td>$\phi 18.5$ $\phi 0.728$ approx.</td> <td>$\phi 0.7$ $\phi 0.028$</td> </tr> <tr> <td>12 0.472</td> <td>$\phi 27$ $\phi 1.063$ approx.</td> <td>$\phi 1.2$ $\phi 0.047$</td> </tr> <tr> <td>14 0.551</td> <td>$\phi 43$ $\phi 1.693$ approx.</td> <td>$\phi 2.0$ $\phi 0.079$</td> </tr> </tbody> </table>	Screw-in depth	Distance to focal point	Spot diameter	7 0.276	$\phi 18.5$ $\phi 0.728$ approx.	$\phi 0.7$ $\phi 0.028$	12 0.472	$\phi 27$ $\phi 1.063$ approx.	$\phi 1.2$ $\phi 0.047$	14 0.551	$\phi 43$ $\phi 1.693$ approx.	$\phi 2.0$ $\phi 0.079$			
Screw-in depth	Distance to focal point	Spot diameter																	
7 0.276	$\phi 18.5$ $\phi 0.728$ approx.	$\phi 0.7$ $\phi 0.028$																	
12 0.472	$\phi 27$ $\phi 1.063$ approx.	$\phi 1.2$ $\phi 0.047$																	
14 0.551	$\phi 43$ $\phi 1.693$ approx.	$\phi 2.0$ $\phi 0.079$																	
Zoom lens (Side-view type)	FX-MR5		FX-MR2 is converted into a side-view type and can be mounted in a very small space. <ul style="list-style-type: none"> Applicable fibers: FD-42G, FD-42GW Ambient temperature: -40 to $+60$ °C -40 to $+140$ °F (Note 2) 	Sensing range for red LED type (mm in) (Note 1) <table border="1"> <thead> <tr> <th>Screw-in depth</th> <th>Distance to focal point</th> <th>Spot diameter</th> </tr> </thead> <tbody> <tr> <td>8 0.315</td> <td>13 0.512 approx.</td> <td>$\phi 0.5$ $\phi 0.020$</td> </tr> <tr> <td>10 0.394</td> <td>15 0.591 approx.</td> <td>$\phi 0.8$ $\phi 0.031$</td> </tr> <tr> <td>14 0.551</td> <td>30 1.181 approx.</td> <td>$\phi 3.0$ $\phi 0.118$</td> </tr> </tbody> </table>	Screw-in depth	Distance to focal point	Spot diameter	8 0.315	13 0.512 approx.	$\phi 0.5$ $\phi 0.020$	10 0.394	15 0.591 approx.	$\phi 0.8$ $\phi 0.031$	14 0.551	30 1.181 approx.	$\phi 3.0$ $\phi 0.118$			
Screw-in depth	Distance to focal point	Spot diameter																	
8 0.315	13 0.512 approx.	$\phi 0.5$ $\phi 0.020$																	
10 0.394	15 0.591 approx.	$\phi 0.8$ $\phi 0.031$																	
14 0.551	30 1.181 approx.	$\phi 3.0$ $\phi 0.118$																	

Notes: 1) The sensing ranges are the values when used in combination with red LED type amplifier. Please contact our office for details on sensing ranges for other types of amplifier.
 2) Refer to "Fiber Selection" for the ambient temperatures of fibers to be used in combination.

FIBER OPTIONS

Model No. when ordering heat-resistant fibers individually as replacement parts

- Heat-resistant side fiber
FT-H20-J20 (one pair set), **FT-H20-J30** (one pair set), **FT-H20-J50** (one pair set), **FT-H20-VJ50** (one pair set), **FT-H20-VJ80** (one pair set)
- Ordinary temperature side fiber
FT-42 (one pair set)

Model No. when ordering vacuum-resistant fibers individually as replacement parts

- Vacuum-resistant fiber
FT-H30-M1V (one pair set)
FD-H30-KZ1V
FD-H30-L32V
- Photo-terminal
FV-BR1 (one pair set)
- Fiber at atmospheric side
FT-J8 (one pair set)

- Mounting bracket for **FD-H30-KZ1V(-S)**
MS-FD-2

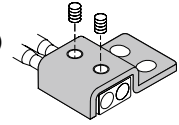

Model No. when ordering accessories additionally

- **RF-003** (Reflector for **FR-KZ50E/KZ50H**)
- **RF-13** (Reflective tape for **FR-Z50HW**)
- **FX-CT2** (Fiber cutter)
- **FX-CT3** (Fiber cutter for $\varnothing 1$ mm $\varnothing 0.039$ in / $\varnothing 1.3$ mm $\varnothing 0.051$ in fiber cable / $\varnothing 4$ mm $\varnothing 0.157$ in protective tube)
- **FX-CT4** (Fiber cutter for $\varnothing 2$ mm $\varnothing 0.079$ in fiber cable / $\varnothing 4$ mm $\varnothing 0.157$ in protective tube)
- **FX-AT2** (Attachment for fixed-length fiber, Orange)
- **FX-AT3** (Attachment for $\varnothing 2.2$ mm $\varnothing 0.087$ in fiber, Clear orange)
- **FX-AT4** (Attachment for $\varnothing 1$ mm $\varnothing 0.039$ in fiber, Black)
- **FX-AT5** (Attachment for $\varnothing 1.3$ mm $\varnothing 0.051$ in fiber, Gray)
- **FX-AT6** (Attachment for $\varnothing 1$ mm $\varnothing 0.039$ in / $\varnothing 1.3$ mm $\varnothing 0.051$ in mixed fiber, Black / Gray)
- **FX-AT4G1** (Gland single for $\varnothing 1$ mm $\varnothing 0.039$ in fiber, Black)
- **FX-AT5G1** (Gland single for $\varnothing 1.3$ mm $\varnothing 0.051$ in fiber, Gray)
- **FX-AT6G1** (Gland single for $\varnothing 1$ mm $\varnothing 0.039$ in / $\varnothing 1.3$ mm $\varnothing 0.051$ in mixed fiber, Black / Gray)
- **FX-SL1** (one pair set) Slit mask for **FT-A11 / FT-A11W**, slit size: 0.5×12 mm 0.020×0.472 in
- **FX-SL2** (one pair set) Slit mask for **FT-A11 / FT-A11W**, slit size: 1×12 mm 0.039×0.472 in
- **FX-SL3** (one pair set) Slit mask for **FT-A11 / FT-A11W**, slit size: 0.5×33 mm 0.020×1.299 in
- **MS-FD-2** (Fiber mounting bracket)

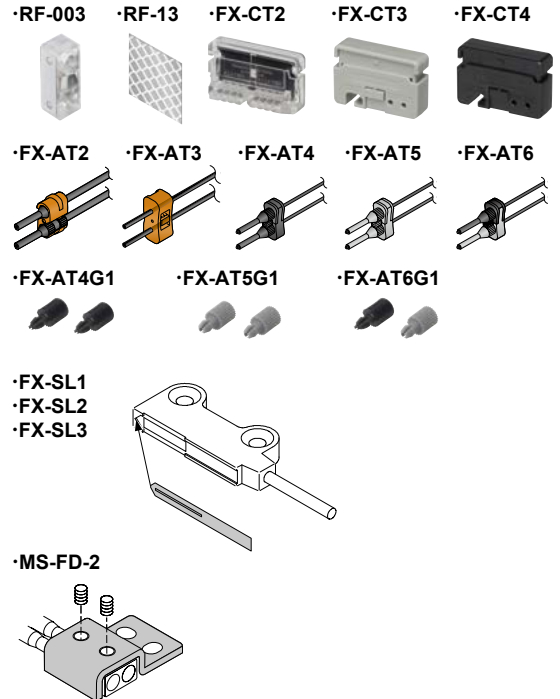

Others

Designation	Model No.	Description	
Protective tube (For thru-beam type fiber)	FTP-500 (0.5 m 1.641 ft)	For M4 thread	The protective tube, made of noncorrosive stainless steel, protects the inner fiber cable from any external forces.
	FTP-1000 (1 m 3.281 ft)		
	FTP-1500 (1.5 m 4.922 ft)		
	FTP-N500 (0.5 m 1.641 ft)	For M3 thread	
	FTP-N1000 (1 m 3.281 ft)		
	FTP-N1500 (1.5 m 4.922 ft)		
Protective tube (For reflective type fiber)	FDP-500 (0.5 m 1.641 ft)	For M6 thread	
	FDP-1000 (1 m 3.281 ft)		
	FDP-1500 (1.5 m 4.922 ft)		
	FDP-N500 (0.5 m 1.641 ft)	For M4 thread	
	FDP-N1000 (1 m 3.281 ft)		
	FDP-N1500 (1.5 m 4.922 ft)		
Fiber bender	FB-1	The fiber bender bends the sleeve part of the fiber head at the proper radius. (Note 1)	
Universal sensor mounting stand	MS-AJ1-F	Horizontal mounting type	Mounting stand assembly for fiber (For M3, M4 or M6 threaded head fiber)
	MS-AJ2-F	Vertical mounting type	
Single-core holder	FX-AT15A	The incident light intensity may vary when using a multi-core fiber or a thin type sharp bending fiber. This holder suppresses the variation in the incident light intensity. Brown.	

Note: 1) Do not bend the sleeve part of any side-view type fiber or ultra-small diameter head type fiber.

Protective tube

- **FTP-□**
- **FDP-□**

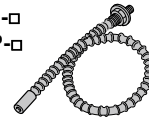

Fiber bender

- **FB-1**



Universal sensor mounting stand

Using the arm which enables adjustment in the horizontal direction, sensing can also be done from above an assembly line.

- **MS-AJ1-F** Swivel: 360° rotation

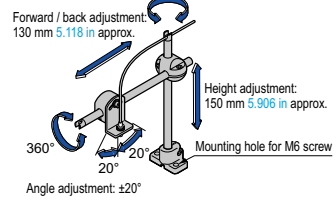

- **MS-AJ2-F** Swivel: 360° rotation

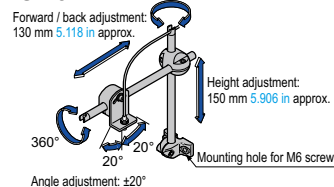

Single-core holder

- **FX-AT15A**



SPECIFICATIONS

Item	Type	NPN output			PNP output			
		Red LED	Blue LED	Green LED	Red LED	Blue LED	Green LED	
Model No.		FX-411	FX-411B	FX-411G	FX-411P	FX-411BP	FX-411GP	
		FX-412 (Note 2)	FX-412B (Note 2)	FX-412G (Note 2)				
CE marking directive compliance	EMC Directive, RoHS Directive							
Supply voltage	12 to 24 V DC $\pm 10\%$ Ripple P-P 10% or less							
Power consumption	<p><Red LED type> Normal operation: 960 mW or less (Current consumption 40 mA or less at 24 V supply voltage) ECO mode: 840 mW or less (Current consumption 35 mA or less at 24 V supply voltage)</p> <p><Blue LED / Green LED type> Normal operation: 720 mW or less (Current consumption 30 mA or less at 24 V supply voltage) ECO mode: 580 mW or less (Current consumption 24 mA or less at 24 V supply voltage)</p>							
Output	<p><NPN output type> NPN open-collector transistor</p> <ul style="list-style-type: none"> Maximum sink current: 100 mA (50 mA, if five, or more, amplifiers are connected in cascade) Applied voltage: 30 V DC or less (between output and 0 V) Residual voltage: 1.5 V or less [at 100 mA sink current (50 mA, if five, or more, amplifiers are connected in cascade)] 			<p><PNP output type> PNP open-collector transistor</p> <ul style="list-style-type: none"> Maximum source current: 100 mA (50 mA, if five, or more, amplifiers are connected in cascade) Applied voltage: 30 V DC or less (between output and +V) Residual voltage: 1.5 V or less [at 100 mA sink current (50 mA, if five, or more, amplifiers are connected in cascade)] 				
	Utilization category	DC-12 or DC-13						
	Output operation	Switchable either Light-ON or Dark-ON						
	Short-circuit protection	Incorporated						
Response time	150 μ s or less (FAST), 500 μ s or less (STD), 4.5 ms or less (U-LG) selectable with setting switch							
Operation indicator	Orange LED (lights up when the output is ON)							
Stability indicator	Green LED (lights up under stable light received condition or stable dark condition)							
Timer function	Incorporated with variable ON-delay / OFF-delay / ONE SHOT timer, switchable either effective or ineffective. [Timer period (Note 3): 1 ms to 3 sec. approx. (1 to 10 ms: Setting possible in units of 1 ms, 10 to 100 ms: Setting possible in units of 10 ms, 100 to 500 ms: Setting possible in units of 50 ms, 500 ms to 1 sec.: Setting possible in units of 100 ms, 1 to 3 sec.: Setting possible in units of 500 ms)]							
Automatic interference prevention function	Incorporated (Up to four sets of fiber heads can be mounted close together. However, U-LG mode is 8 fiber heads.)(Note 4)							
Environmental resistance	Pollution degree	3 (Industrial environment)						
	Ambient temperature	-10 to +55 °C -14 to +131 °F (If 4 to 7 units are connected in cascade: -10 to +50 °C +14 to +122 °F, if 8 to 16 units are connected in cascade: -10 to +45 °C +14 to +113 °F) (No dew condensation or icing allowed), Storage: -20 to +70 °C -4 to +158 °F						
	Ambient humidity	35 to 85 % RH, Storage: 35 to 85 % RH						
	Ambient illuminance	Incandescent light: 3,000 lx or less at the light-receiving face						
	Voltage withstandability	1,000 V AC for one min. between all supply terminals connected together and enclosure (Note 5)						
	Insulation resistance	20 M Ω , or more, with 250 V DC megger between all supply terminals connected together and enclosure (Note 5)						
	Vibration resistance	10 to 150 Hz frequency, 0.75 mm 0.030 in double amplitude in X, Y and Z directions for two hours each						
	Shock resistance	98 m/s ² acceleration (10 G approx.) in X, Y and Z directions five times each						
Emitting element (modulated)	Red LED	Blue LED	Green LED	Red LED	Blue LED	Green LED		
Peak emission wavelength	650 nm 0.026 mil	470 nm 0.019 mil	525 nm 0.021 mil	650 nm 0.026 mil	470 nm 0.019 mil	525 nm 0.021 mil		
Material	Enclosure: Heat-resistant ABS, Case cover: Polycarbonate							
Cable length	Total length up to 100 m 328.084 ft (50 m 164.042 ft for 5 to 8 units, 20 m 65.617 ft for 9 to 16 units) is possible with 0.3 mm ² , or more, cable.							
Weight	Net weight: 20 g approx., Gross weight: 30 g approx.							

Notes: 1) Where measurement conditions have not been specified precisely, the conditions used were an ambient temperature of +23 °C **+73.4 °F**.

2) The **FX-412** has a threshold value adjuster that can be adjusted with your fingers.

3) For models manufactured up until June 2005, the timer period is approx. 1 to 500 ms.

4) When the power supply is switched on, the light emission timing is automatically set for interference prevention.

5) The voltage withstandability and the insulation resistance values given in the above table are for the amplifier only.

I/O CIRCUIT DIAGRAMS**FX-41□**

NPN output type

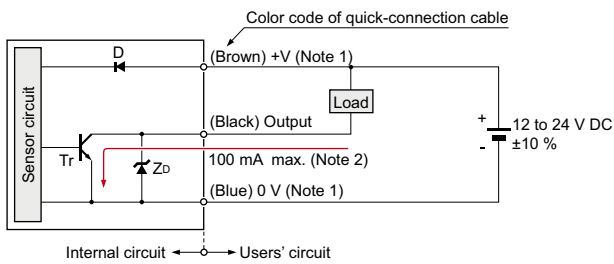

Notes: 1) The quick-connection sub cable does not have +V (brown) and 0 V (blue). The power is supplied from the connector of the main cable.
2) 50 mA max., if five amplifiers, or more, are connected together.

Symbols ... D : Reverse supply polarity protection diode
Zd: Surge absorption zener diode
Tr : NPN output transistor

FX-41□P

PNP output type

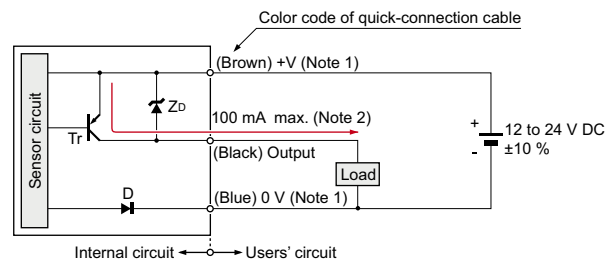

Notes: 1) The quick-connection sub cable does not have +V (brown) and 0 V (blue). The power is supplied from the connector of the main cable.
2) 50 mA max., if five amplifiers, or more, are connected together.

Symbols ... D : Reverse supply polarity protection diode
Zd: Surge absorption zener diode
Tr : PNP output transistor

PRECAUTIONS FOR PROPER USE

- Never use this product as a sensing device for personnel protection.
- In case of using sensing devices for personnel protection, use products which meet laws and standards, such as OSHA, ANSI or IEC etc., for personnel protection applicable in each region or country.

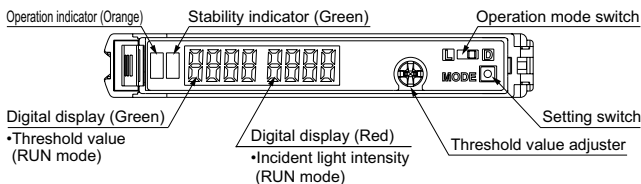
Part description**Wiring**

- Make sure that the power supply is off while wiring.
- Verify that the supply voltage variation is within the rating.
- Take care that if a voltage exceeding the rated range is applied, or if an AC power supply is directly connected, the product may get burnt or damaged.
- In case noise generating equipment (switching regulator, inverter motor, etc.) is used in the vicinity of this product, connect the frame ground (F.G.) terminal of the equipment to an actual ground.
- If power is supplied from a commercial switching regulator, ensure that the frame ground (F.G.) terminal of the power supply is connected to an actual ground.
- Take care that short circuit of the load wrong wiring may burn or damage the product.
- Do not run the wires together with high-voltage lines or power lines or put them in the same raceway. This can cause malfunction due to induction.
- Extension up to total 100 m **328.084 ft** (if 5 to 8 units are connected in cascade: 50 m **164.042 ft**, if 9 to 16 units are connected in cascade: 20 m **65.617 ft**) is possible with 0.3 mm², or more, cable. However, in order to reduce noise, make the wiring as short as possible.
- Take care that cable extension increases the residual voltage.

Mounting

- Make sure that the power supply is off while connecting/disconnecting the amplifiers and the quick-connection cables.

How to mount the amplifier

- ① Fit the rear part of the mounting section of the amplifier on a width DIN rail.
- ② Press down the rear part of the mounting section of the unit on the width DIN rail and fit the front part of the mounting section to the DIN rail.

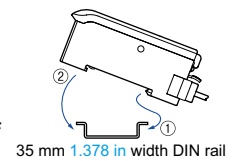
**How to remove the amplifier**

- ① Push the amplifier forward.
- ② Lift up the front part of the amplifier to remove it.

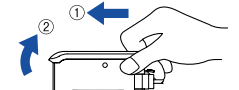

Note: Take care that if the front part is lifted without pushing the amplifier forward, the hook on the rear portion of the mounting section is likely to break.

Fiber installation

- Insert the fiber into the amplifier after attaching the attachment. Refer to the "Instruction Manual" included with the fiber for details.

- ① Push the fiber lock lever down.
- ② Slowly insert the fiber into the insertion slot until it stops. (Note 1)
- ③ Push the fiber lock lever back up until it stops.

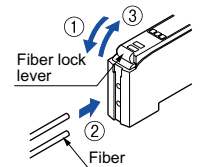

Notes: 1) Note that if the fiber is not fully inserted, the sensing distance will decrease. Also note that the bending-resistant fiber may bend during insertion.

- 2) In case of coaxial reflective type fibers, mount the central fiber (single-core) to the emitter part and the peripheral fiber (multi-core) to the receiver. Note that sensing precision will deteriorate when done in reverse.

PRECAUTIONS FOR PROPER USE

Cascading

- Make sure that the power supply is off while adding or removing the amplifiers.
- Make sure to check the allowable ambient temperature, as it depends on the number of amplifiers connected in cascade.
- In case two, or more, amplifiers are connected in cascade, make sure to mount them on a DIN rail.
- When the amplifiers move on the DIN rail depending on the attaching condition or the amplifiers are mounted close to each other in cascade, fit them between the optional end plates (**MS-DIN-E**) mounted at the two ends.
- Up to maximum 15 amplifiers can be added (total 16 amplifiers connected in cascade.)
- When connecting more than two amplifiers in cascade, use the sub cable (**CN-71-C**) as the quick-connection cable for the second amplifier onwards.
- When connecting amplifiers not close to each other in parallel, be sure to mount the optional end plate (**MS-DIN-E**) at both sides of each amplifier or affix the communication window seal of the optional fiber amplifier protection seal (**FX-MB1**) to the communication windows. For details, refer to the instruction manual enclosed with the **FX-MB1**.
- When the different LED (red / blue / green) types are connected in cascade, mount the identical models together.
- When this product is used with the other digital fiber amplifiers, be sure to place this product to the left most position (When you look from the connector side). If this product is not placed to the leftmost position, this product may not operate properly.

Cascading method

- ① Mount the amplifiers, one by one, on the DIN rail.
- ② Slide the amplifiers next to each other, and connect the quick-connection cables.
- ③ Mount the optional end plates (**MS-DIN-E**) at both the ends to hold the amplifiers between their flat sides.
- ④ Tighten the screws to fix the end plates.

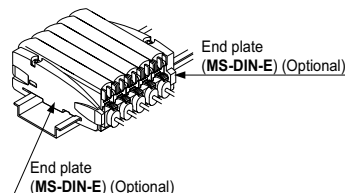
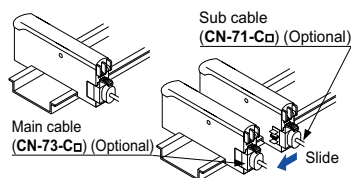

Dismantling

- ① Loosen the screws of the end plates.
- ② Remove the end plates.
- ③ Slide the amplifiers and remove them one by one.

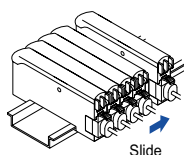

Switching output operation

- The operation selection switch can be used to display different output operations (L-ON / D-ON) on the digital display.

When set to Dark-ON (D-ON)



When set to Light-ON (L-ON)



Threshold value (sensitivity) adjustment

- ① Check the incident light intensity [in the digital display (red)] when a sensing object is placed in the sensing position. (Incident light intensity)
- ② Check the incident light intensity [in the digital display (red)] when the sensing object is removed from the sensing position. (Incident light intensity)
- ③ Turn the threshold value adjuster to the threshold value [in the digital display (green)] that is the value in between ① and ②. (The threshold value is automatically written to the EEPROM.) (Threshold value)

Threshold value setting method

- When the threshold value adjuster is turned clockwise, the threshold value increases. When the threshold value adjuster is turned counterclockwise, the threshold value decreases.



- If there is a sufficient level of margin in the incident light intensity, the stability indicator (green) will light up.

Mode selection

- When the setting switch is pressed and held for 2 sec. or more, "SET" mode (mode setting screen) is activated.
- If the setting switch is pressed while in "SET" mode, the mode will change.
- If the threshold value adjuster is turned while a mode is active, the setting item will change and blink.
- When the setting switch is pressed at the item you would like to set, it blinks 3 times and then the setting is confirmed and the mode switches to the next mode.
- If the setting switch is pressed and held for 2 sec. or more or do not press any key for 15 sec. while "SET" mode is active, the mode will switch automatically to "RUN" mode.

PRECAUTIONS FOR PROPER USE

Mode table

Mode	Factory setting	Description
Response time change mode	SPEd 5td	The response time can be set.
Light-emitting amount selection mode (Note 1)	PEL 0000	The light-emitting amount can be switched among four levels.
Timer setting mode	delY non	Timer settings can be selected; Without timer / OFF-delay timer / ON-delay timer / ONE SHOT timer. Also the timer period can be set.
Digital display inversion mode	turn off	The display on the digital display can be inverted.
Eco mode (Note 2)	Eco off	If no key is pressed for 20 sec. approx. while in "RUN" mode, the digital display turns off automatically. Press the setting switch or move the operation mode switch to make the display light up again. The digital display will light up when the threshold value adjuster is turned, but note that this will also cause the threshold value to change.
Peak / Bottom hold mode	Hold off	If the setting switch is pressed while "RUN" mode is active, the display will alternate between the peak hold value and the bottom hold value. (The display will refresh every 2 sec.) The display will return to normal if any operation other than threshold value setting is carried out.

Notes: 1) This mode is not incorporated in the blue LED type and green LED type.
 2) While the peak / bottom hold mode is ON, the digital display is not turned off even if the Eco mode is set to ON.

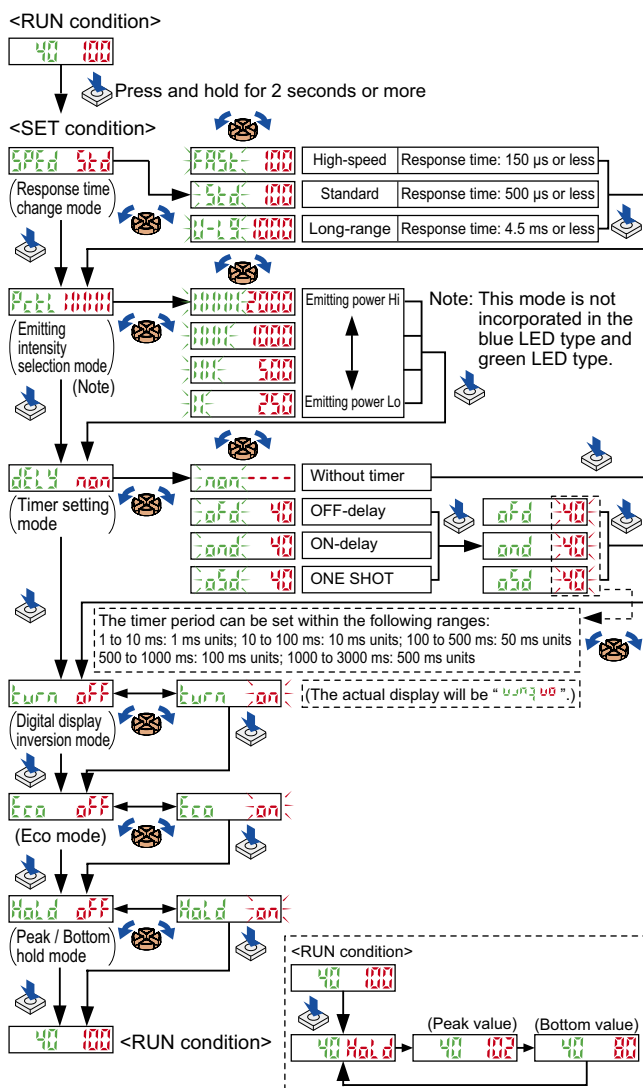

Key lock function

- When the setting switch is pressed and held for 5 sec. while in 'RUN' mode, the key lock function can be set / canceled.
- When the key lock function is set to ON, even if the threshold value adjuster or the setting switch is operated, "Loc" is displayed and the key operation cannot be carried out.

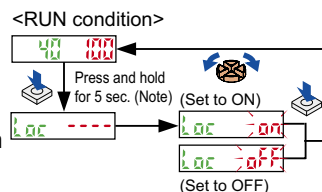

Note: Although the display changes to the indication of 'SET' condition 2 sec. after pressing the setting switch, keep pressing the switch. Furthermore, the sensor does not go into the key lock setting from 'SET' condition.

Factory setting

- When the setting switch is pressed and held for 10 sec., until "----" is displayed while in 'RUN' mode, the all settings are returned to the factory setting. (For the factory setting, refer to 'Mode table' in 'Mode selection'.)

Error display indicator readings

Display	Error description	Measures
Er-1	The load has short-circuited and excess current is flowing.	Turn off the power, then check the load.
Er-5	Communication error has occurred at time of connection.	Check if the mounted amplifiers are in close contact with each other.

Others

- This product has been developed / produced for industrial use only.
- Do not use during the initial transient time (0.5 sec.) after the power supply is switched on.
- This sensor is suitable for indoor use only.
- Do not use this sensor in places having excessive vapor, dust, etc., or where it may come in contact with corrosive gas.
- Take care that the sensor does not come in direct contact with oil, grease, organic solvents, such as, thinner etc., or strong acid, and alkaline.
- This sensor cannot be used in an environment containing inflammable or explosive gases.
- Never disassemble or modify the sensor.
- The changes to the settings are written to the EEPROM, but because the EEPROM has a limited service life, you should avoid changing the settings any more than 1 million times.

DIMENSIONS (Unit: mm in)

The CAD data can be downloaded from our website.

FX-411□ FX-411□P Amplifier

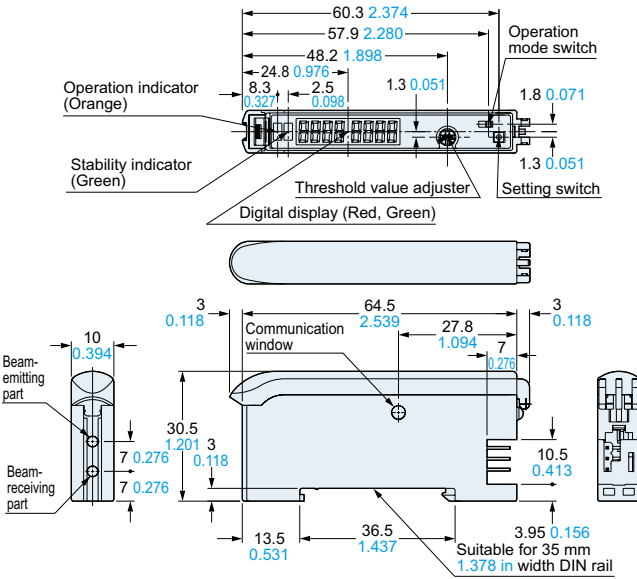

FX-412□ Amplifier

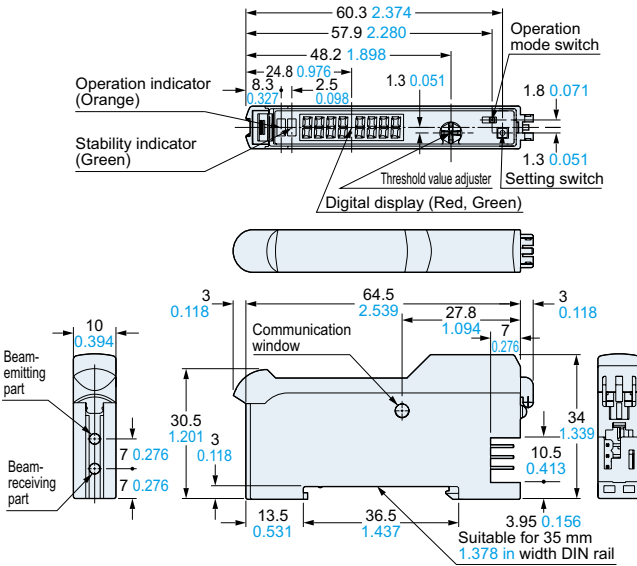

CN-71-C1 CN-71-C2 CN-71-C5 Sub cable (Optional)

• Length L

Model No.	Length L
CN-71-C1	1,000 39.370
CN-71-C2	2,000 78.740
CN-71-C5	5,000 196.850

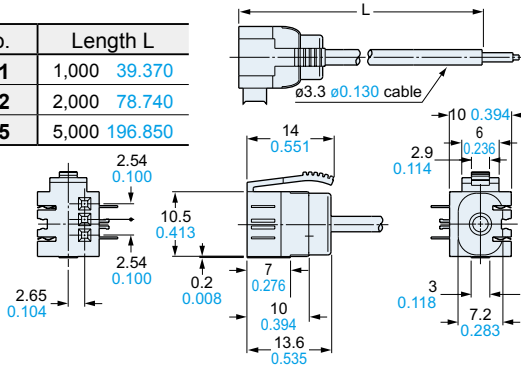

CN-73-C1 CN-73-C2 CN-73-C5 Main cable (Optional)

• Length L

Model No.	Length L
CN-73-C1	1,000 39.370
CN-73-C2	2,000 78.740
CN-73-C5	5,000 196.850

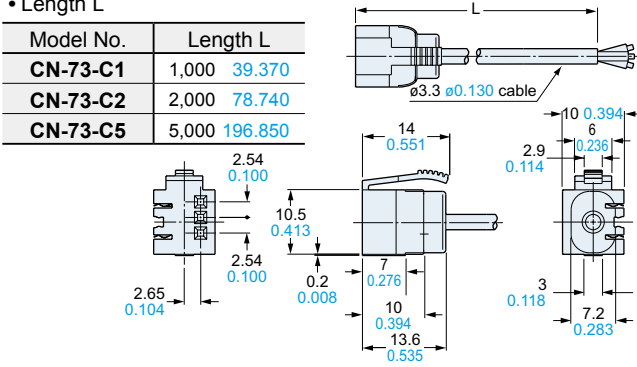

MS-DIN-E End plate (Optional)

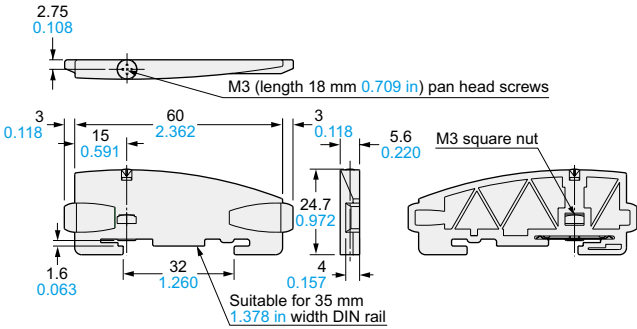

Material: Polycarbonate

MS-DIN-2 Amplifier mounting bracket (Optional)

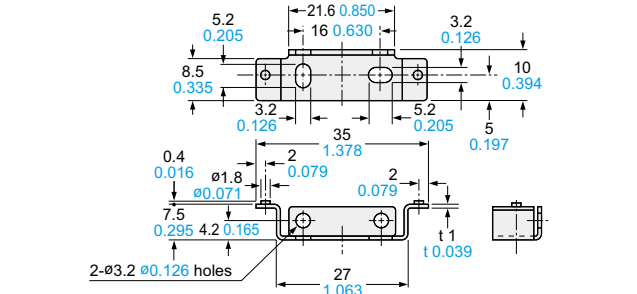

Material: Cold rolled carbon steel (SPCC) (Uni-chrome plated)

Disclaimer

The applications described in the catalog are all intended for examples only. The purchase of our products described in the catalog shall not be regarded as granting of a license to use our products in the described applications. We do NOT warrant that we have obtained some intellectual properties, such as patent rights, with respect to such applications, or that the described applications may not infringe any intellectual property rights, such as patent rights, of a third party.

Panasonic
INDUSTRY

Panasonic Industry Co., Ltd.

Industrial Device Business Division

7-1-1, Morofuku, Daito-shi, Osaka 574-0044, Japan

industrial.panasonic.com/ac/e/