

LM2825 Integrated Power Supply 1A DC-DC Converter

Check for Samples: [LM2825](#)

FEATURES

- Minimum Design Time Required
- 3.3V, 5V and 12V Fixed Output Versions
- Two Adjustable Versions Allow 1.23V to 15V Outputs
- Wide Input Voltage Range, up to 40V
- Low-Power Standby Mode, I_Q Typically 65 μ A
- High Efficiency, Typically 80%
- $\pm 4\%$ Output Voltage Tolerance
- Excellent Line and Load Regulation
- TTL Shutdown Capability/Programmable Soft-Start
- Thermal Shutdown and Current Limit Protection
- -40°C to $+85^\circ\text{C}$ Ambient Temperature Range

APPLICATIONS

- Simple High-Efficiency Step-Down (Buck) Regulator
- On-Card Switching Regulators
- Efficient Pre-Regulator for Linear Regulators
- Distributed Power Systems
- DC/DC Module Replacement

HIGHLIGHTS

- No External Components Required (Fixed Output Voltage Versions)
- Integrated Circuit Reliability
- MTBF Over 20 Million Hours
- Radiated EMI Meets Class B Stipulated by CISPR 22
- High Power Density, 35 W/in³
- 24-pin PDIP Package Profile (1.25 x 0.54 x 0.26 Inches)

DESCRIPTION

The LM2825 is a complete 1A DC-DC Buck converter packaged in a 24-lead molded Dual-In-Line integrated circuit package.

Contained within the package are all the active and passive components for a high efficiency step-down (buck) switching regulator. Available in fixed output voltages of 3.3V, 5V and 12V, as well as two adjustable versions, these devices can provide up to 1A of load current with fully ensured electrical specifications.

Self-contained, this converter is also fully protected from output fault conditions, such as excessive load current, short circuits, or excessive temperatures.

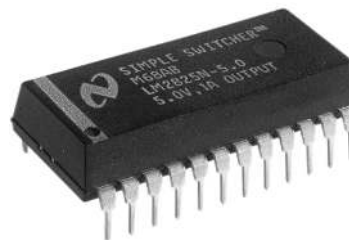

Standard Application

(Fixed output voltage versions)

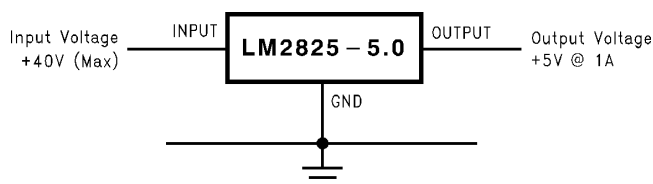

Radiated EMI

Radiated emission of electromagnetic fields is measured at 10m distance. The emission levels are within the Class B limits stipulated by CISPR 22.

30. . . 230 MHz	30 dB μ V/m
230. . . 1000 MHz	37 dB μ V/m
1. . . 10 GHz	46 dB μ V/m



Please be aware that an important notice concerning availability, standard warranty, and use in critical applications of Texas Instruments semiconductor products and disclaimers thereto appears at the end of this data sheet.

Connection Diagram

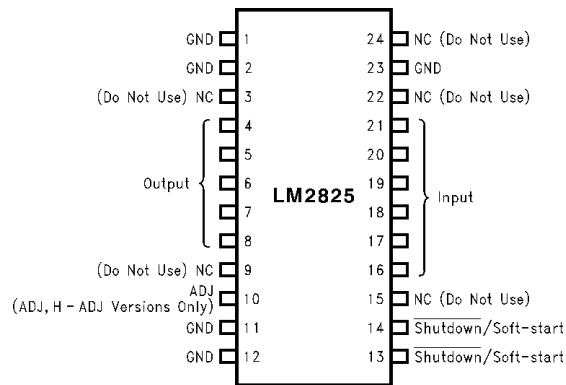

“NC (Do not use)” pins: See [Figure 25](#)

**Figure 1. PDIP Package
Top View
See Package Number NFL**



These devices have limited built-in ESD protection. The leads should be shorted together or the device placed in conductive foam during storage or handling to prevent electrostatic damage to the MOS gates.

Absolute Maximum Ratings⁽¹⁾⁽²⁾

Maximum Input Supply (V_{IN})		+45V
SD/SS Pin Input Voltage ⁽³⁾		6V
Output Pin Voltage	(3.3V, 5.0V and ADJ)	$-1V \leq V \leq 9V$
	(12V and H-ADJ)	$-1V \leq V \leq 16V$
ADJ Pin Voltage (ADJ, H-ADJ only)		$-0.3V \leq V \leq 25V$
Power Dissipation		Internally Limited
Storage Temperature Range		-40°C to $+125^{\circ}\text{C}$
ESD Susceptibility	Human Body Model ⁽⁴⁾	2 kV
Lead Temperature (Soldering 10 sec.)		260°C

- (1) Absolute Maximum Ratings indicate limits beyond which damage to the device may occur. Operating Ratings indicate conditions for which the device is intended to be functional, but do not ensure specific performance limits. For ensured specifications and test conditions, see the [Electrical Characteristics](#).
- (2) If Military/Aerospace specified devices are required, please contact the Texas Instruments Sales Office/Distributors for availability and specifications.
- (3) Voltage internally clamped. If clamp voltage is exceeded, limit current to a maximum of 5 mA.
- (4) The human body model is a 100 pF capacitor discharged through a 1.5k resistor into each pin.

Operating Ratings

Ambient Temperature Range	$-40^{\circ}\text{C} \leq T_A \leq +85^{\circ}\text{C}$
Junction Temperature Range	$-40^{\circ}\text{C} \leq T_J \leq +125^{\circ}\text{C}$
Input Supply Voltage (3.3V version)	4.75V to 40V
Input Supply Voltage (5V version)	7V to 40V
Input Supply Voltage (12V version)	15V to 40V
Input Supply Voltage (-ADJ, H-ADJ)	4.5V to 40V

LM2825-3.3 Electrical Characteristics⁽¹⁾

Specifications with standard type face are for $T_A = 25^\circ\text{C}$, and those with **boldface type** apply over **full Operating Temperature Range**. Test Circuit, see [Figure 17](#).

Symbol	Parameter	Conditions	LM2825-3.3		Units (Limits)
			Typical ⁽²⁾	Limit ⁽³⁾	
V_{OUT}	Output Voltage	$4.75\text{V} \leq V_{\text{IN}} \leq 40\text{V}$, $0.1\text{A} \leq I_{\text{LOAD}} \leq 1\text{A}$	3.3	3.168/ 3.135 3.432/ 3.465	V V(min) V(max)
	Line Regulation	$4.75\text{V} \leq V_{\text{IN}} \leq 40\text{V}$ $I_{\text{LOAD}} = 100\text{ mA}$	1.5		mV
	Load Regulation	$0.1\text{A} \leq I_{\text{LOAD}} \leq 1\text{A}$ $V_{\text{IN}} = 12\text{V}$	8		mV
	Output Ripple Voltage	$V_{\text{IN}} = 12\text{V}$, $I_{\text{LOAD}} = 1\text{A}$	40		mV p-p
η	Efficiency	$V_{\text{IN}} = 12\text{V}$, $I_{\text{LOAD}} = 0.5\text{A}$	75		%

- (1) When the LM2825 is used as shown in [Figure 17](#) test circuit, system performance will be as shown in [Electrical Characteristics](#).
- (2) Typical numbers are at 25°C and represent the most likely norm.
- (3) All limits ensured at room temperature (standard type face) and at temperature extremes (bold type face) when output current is limited to the value given in the temperature derating curves. See the [Application Information](#) section for curves. All limits at temperature extremes are ensured using standard Statistical Quality Control (SQC) methods. All limits are used to calculate Average Outgoing Quality Level (AOQL).

LM2825-5.0 Electrical Characteristics⁽¹⁾

Specifications with standard type face are for $T_A = 25^\circ\text{C}$, and those with **boldface type** apply over **full Operating Temperature Range**. Test Circuit, see [Figure 17](#).

Symbol	Parameter	Conditions	LM2825-5.0		Units (Limits)
			Typical ⁽²⁾	Limit ⁽³⁾	
V_{OUT}	Output Voltage	$7\text{V} \leq V_{\text{IN}} \leq 40\text{V}$, $0.1\text{A} \leq I_{\text{LOAD}} \leq 1\text{A}$	5.0	4.800/ 4.750 5.200/ 5.250	V V(min) V(max)
	Line Regulation	$7\text{V} \leq V_{\text{IN}} \leq 40\text{V}$ $I_{\text{LOAD}} = 100\text{ mA}$	2.7		mV
	Load Regulation	$0.1\text{A} \leq I_{\text{LOAD}} \leq 1\text{A}$ $V_{\text{IN}} = 12\text{V}$	8		mV
	Output Ripple Voltage	$V_{\text{IN}} = 12\text{V}$, $I_{\text{LOAD}} = 1\text{A}$	40		mV p-p
η	Efficiency	$V_{\text{IN}} = 12\text{V}$, $I_{\text{LOAD}} = 0.5\text{A}$	80		%

- (1) When the LM2825 is used as shown in [Figure 17](#) test circuit, system performance will be as shown in [Electrical Characteristics](#).
- (2) Typical numbers are at 25°C and represent the most likely norm.
- (3) All limits ensured at room temperature (standard type face) and at temperature extremes (bold type face) when output current is limited to the value given in the temperature derating curves. See the [Application Information](#) section for curves. All limits at temperature extremes are ensured using standard Statistical Quality Control (SQC) methods. All limits are used to calculate Average Outgoing Quality Level (AOQL).

LM2825-12 Electrical Characteristics⁽¹⁾

Specifications with standard type face are for $T_A = 25^\circ\text{C}$, and those with **boldface type** apply over **full Operating Temperature Range**. Test Circuit, see [Figure 17](#).

Symbol	Parameter	Conditions	LM2825-12		Units (Limits)
			Typical ⁽²⁾	Limit ⁽³⁾	
V_{OUT}	Output Voltage	$15\text{V} \leq V_{\text{IN}} \leq 40\text{V}$, $0.1\text{A} \leq I_{\text{LOAD}} \leq 0.75\text{A}$	12.0	11.52/ 11.40 12.48/ 12.60	V V(min) V(max)
	Line Regulation	$15\text{V} \leq V_{\text{IN}} \leq 40\text{V}$ $I_{\text{LOAD}} = 100\text{ mA}$	8.5		mV
	Load Regulation	$0.1\text{A} \leq I_{\text{LOAD}} \leq 0.75\text{A}$ $V_{\text{IN}} = 24\text{V}$	12		mV
	Output Ripple Voltage	$V_{\text{IN}} = 24\text{V}$, $I_{\text{LOAD}} = 1\text{A}$	100		mV p-p
η	Efficiency	$V_{\text{IN}} = 24\text{V}$, $I_{\text{LOAD}} = 0.5\text{A}$	87		%

- (1) When the LM2825 is used as shown in [Figure 17](#) test circuit, system performance will be as shown in [Electrical Characteristics](#).
- (2) Typical numbers are at 25°C and represent the most likely norm.
- (3) All limits ensured at room temperature (standard type face) and at temperature extremes (bold type face) when output current is limited to the value given in the temperature derating curves. See the [Application Information](#) section for curves. All limits at temperature extremes are ensured using standard Statistical Quality Control (SQC) methods. All limits are used to calculate Average Outgoing Quality Level (AOQL).

LM2825-ADJ Electrical Characteristics⁽¹⁾

Specifications with standard type face are for $T_A = 25^\circ\text{C}$, and those with **boldface type** apply over **full Operating Temperature Range**. Test Circuit, see [Figure 18](#).

Symbol	Parameter	Conditions	LM2825-ADJ		Units (Limits)
			Typical ⁽²⁾	Limit ⁽³⁾	
V_{ADJ}	Adjust Pin Voltage	$4.5\text{V} \leq V_{\text{IN}} \leq 40\text{V}$, $0.1\text{A} \leq I_{\text{LOAD}} \leq 1\text{A}$ $1.23\text{V} \leq V_{\text{OUT}} \leq 8\text{V}$	1.230	1.193/ 1.180 1.267/ 1.280	V V(min) V(max)
η	Efficiency	$V_{\text{IN}} = 12\text{V}$, $I_{\text{LOAD}} = 0.5\text{A}$ V_{OUT} Programmed for 3V. See Circuit of Figure 18	74		%

- (1) When the LM2825 is used as shown in [Figure 18](#) test circuit, system performance will be as shown in [Electrical Characteristics](#).
- (2) Typical numbers are at 25°C and represent the most likely norm.
- (3) All limits ensured at room temperature (standard type face) and at temperature extremes (bold type face) when output current is limited to the value given in the temperature derating curves. See the [Application Information](#) section for curves. All limits at temperature extremes are ensured using standard Statistical Quality Control (SQC) methods. All limits are used to calculate Average Outgoing Quality Level (AOQL).

LM2825H-ADJ Electrical Characteristics⁽¹⁾

Specifications with standard type face are for $T_A = 25^\circ\text{C}$, and those with **boldface type** apply over **full Operating Temperature Range**. Test Circuit, see [Figure 18](#).

Symbol	Parameter	Conditions	LM2825H-ADJ		Units (Limits)
			Typical ⁽²⁾	Limit ⁽³⁾	
V_{ADJ}	Adjust Pin Voltage	$9\text{V} \leq V_{\text{IN}} \leq 40\text{V}$, $0.1\text{A} \leq I_{\text{LOAD}} \leq 0.55\text{A}$ $7\text{V} \leq V_{\text{OUT}} \leq 15\text{V}$	1.230	1.193/ 1.180 1.267/ 1.280	V V(min) V(max)
η	Efficiency	$V_{\text{IN}} = 24\text{V}$, $I_{\text{LOAD}} = 0.5\text{A}$ V_{OUT} Programmed for 12V. See Circuit of Figure 18	87		%

- (1) When the LM2825 is used as shown in [Figure 18](#) test circuit, system performance will be as shown in [Electrical Characteristics](#).
- (2) Typical numbers are at 25°C and represent the most likely norm.
- (3) All limits ensured at room temperature (standard type face) and at temperature extremes (bold type face) when output current is limited to the value given in the temperature derating curves. See the [Application Information](#) section for curves. All limits at temperature extremes are ensured using standard Statistical Quality Control (SQC) methods. All limits are used to calculate Average Outgoing Quality Level (AOQL).

All Output Voltage Versions Electrical Characteristics

Specifications with standard type face are for $T_A = 25^\circ\text{C}$, and those with **boldface type** apply over **full Operating Range**. Unless otherwise specified, $V_{IN} = 12\text{V}$ for 3.3V, 5.0V and ADJ versions, $V_{IN} = 24\text{V}$ for 12V and H-ADJ versions, $I_{LOAD} = 100\text{ mA}$.

Symbol	Parameter	Conditions	LM2825-XX		Units (Limits)
			Typical ⁽¹⁾	Limit ⁽²⁾	
I_{CL}	DC Output Current Limit	$R_L = 0\Omega$	1.4	1.2 2.4	A A(min) A(max)
I_Q	Operating Quiescent Current	SD/SS Pin = 3.1V ⁽³⁾	5	10	mA mA(max)
I_{STBY}	Standby Quiescent Current	SD/SS Pin = 0V ⁽³⁾	65	200	μA $\mu\text{A(max)}$
I_{ADJ}	Adjust Pin Bias Current	Adjustable Versions Only, $V_{FB} = 1.3\text{V}$	6	50/100	nA nA(max)
f_O	Oscillator Frequency	See ⁽⁴⁾	150		kHz
θ_{JA}	Thermal Resistance	Junction to Ambient ⁽⁵⁾	30		$^\circ\text{C/W}$
SHUTDOWN/SOFT-START CONTROL Test Circuit, see Figure 17					
V_{SD}	Shutdown Threshold Voltage	Low (Shutdown Mode) High (Soft-start Mode)	1.3	0.6 2.0	V V(max) V(min)
V_{SS}	Soft-start Voltage	$V_{OUT} = 20\%$ of Nominal Output Voltage $V_{OUT} = 100\%$ of Nominal Output Voltage	2 3		V
I_{SD}	Shutdown Current	$V_{SHUTDOWN} = 0.5\text{V}$ ⁽³⁾	5	10	μA $\mu\text{A(max)}$
I_{SS}	Soft-start Current	$V_{SOFT-START} = 2.5\text{V}$ ⁽³⁾	1.6	5	μA $\mu\text{A(max)}$

- (1) Typical numbers are at 25°C and represent the most likely norm.
- (2) All limits ensured at room temperature (standard type face) and at temperature extremes (bold type face) when output current is limited to the value given in the temperature derating curves. See the [Application Information](#) section for curves. All limits at temperature extremes are ensured using standard Statistical Quality Control (SQC) methods. All limits are used to calculate Average Outgoing Quality Level (AOQL).
- (3) $I_{LOAD} = 0\text{A}$.
- (4) The switching frequency is reduced when the second stage current limit is activated. The amount of reduction is determined by the severity of current overload.
- (5) Junction to ambient thermal resistance (no external heat sink) for the PDIP package with the leads soldered to a printed circuit board with (1 oz.) copper area of approximately 2 in^2 .

Typical Performance Characteristics

(Circuits of [Figure 17](#) and [Figure 18](#)) Unless otherwise specified, $V_{IN} = 12V$ for 3.3V, 5.0V and ADJ versions, $V_{IN} = 24V$ for 12V and H-ADJ versions, $I_{LOAD} = 100\text{ mA}$, $T_A = 25^\circ\text{C}$

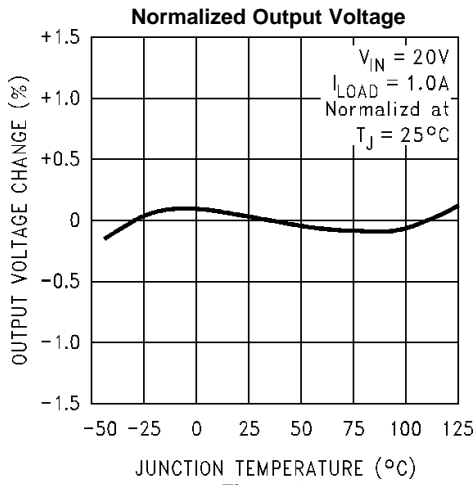

Figure 2.

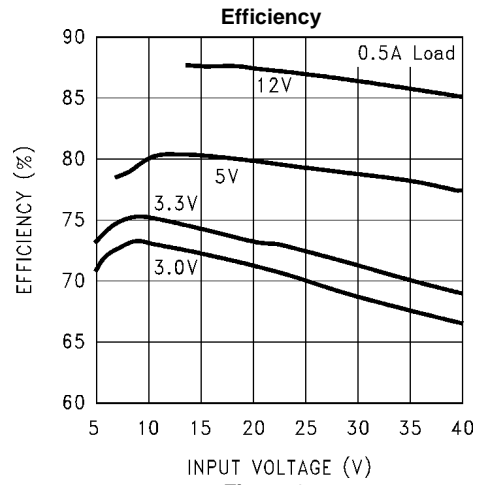

Figure 3.

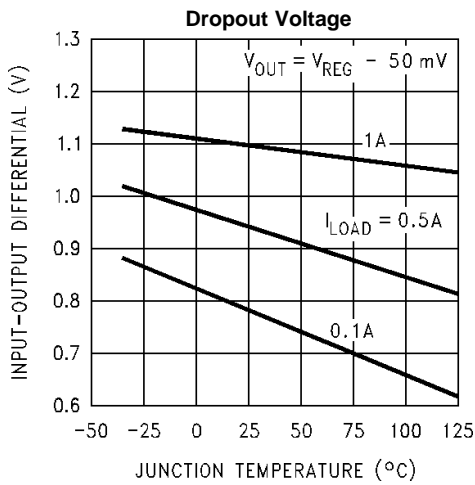

Figure 4.

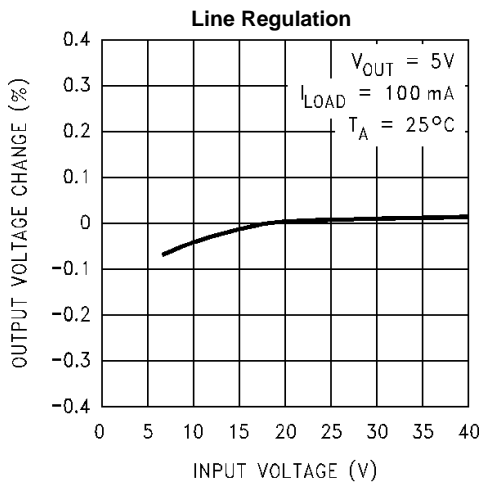

Figure 5.

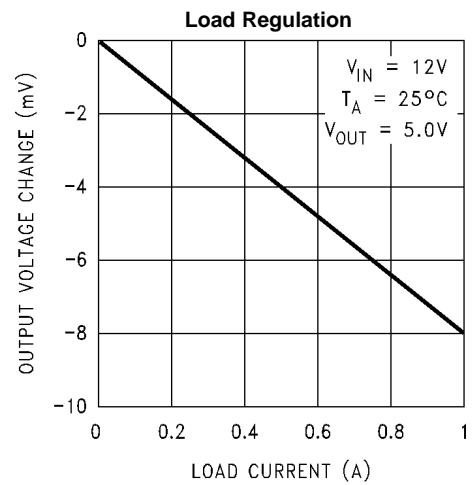

Figure 6.

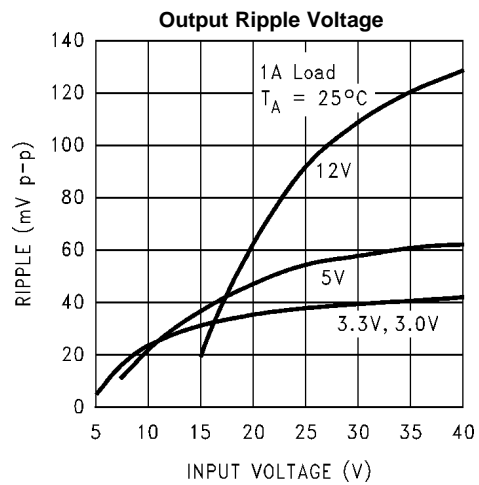

Figure 7.

Typical Performance Characteristics (continued)

(Circuits of Figure 17 and Figure 18) Unless otherwise specified, $V_{IN} = 12V$ for 3.3V, 5.0V and ADJ versions, $V_{IN} = 24V$ for 12V and H-ADJ versions, $I_{LOAD} = 100\text{ mA}$, $T_A = 25^\circ\text{C}$

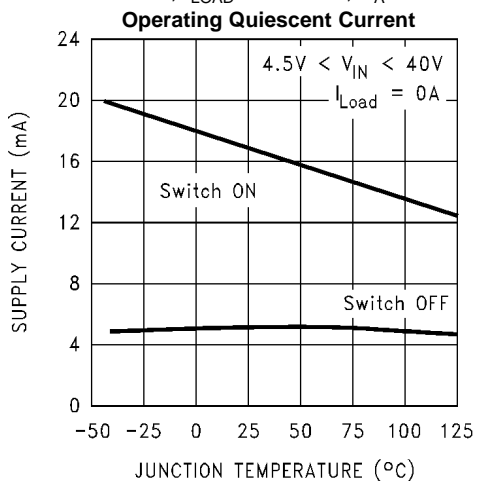

Figure 8.

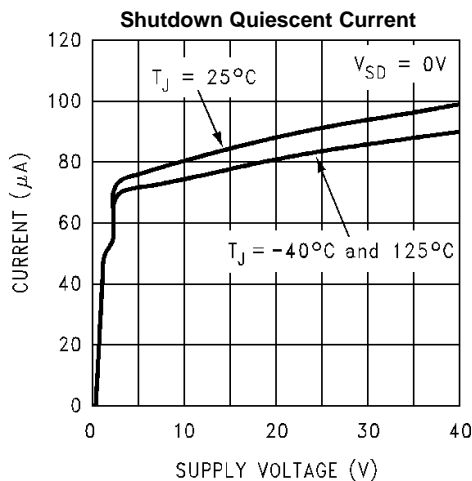

Figure 9.

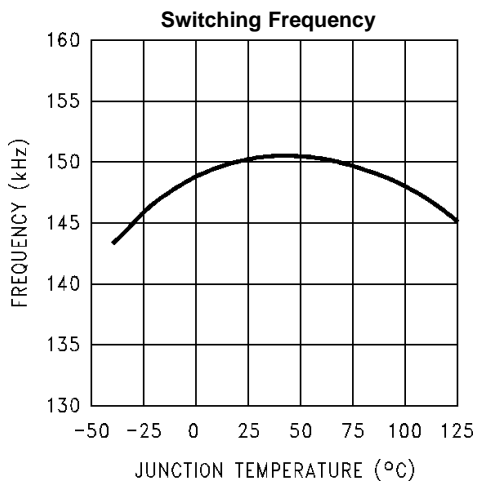

Figure 10.

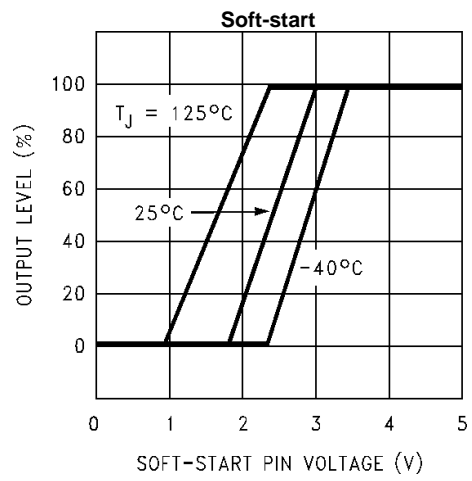

Figure 11.

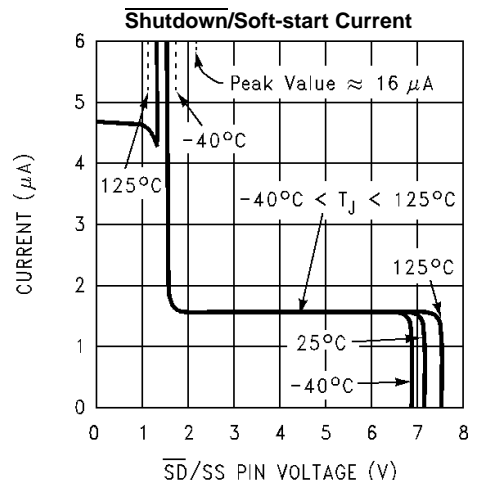

Figure 12.

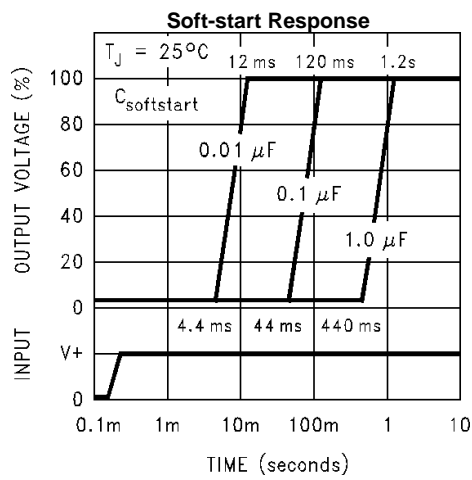

Figure 13.

Typical Performance Characteristics (continued)

(Circuits of [Figure 17](#) and [Figure 18](#)) Unless otherwise specified, $V_{IN} = 12V$ for 3.3V, 5.0V and ADJ versions, $V_{IN} = 24V$ for 12V and H-ADJ versions, $I_{LOAD} = 100\text{ mA}$, $T_A = 25^\circ C$

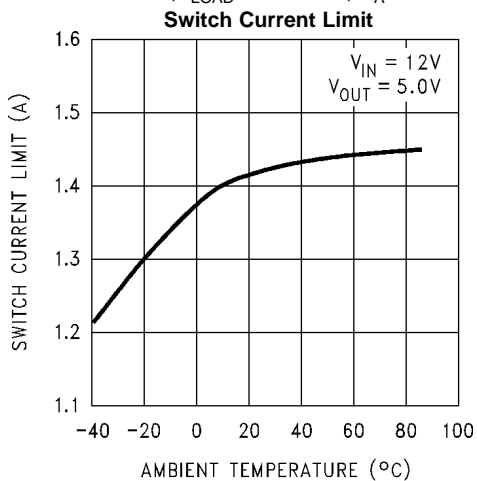

Figure 14.

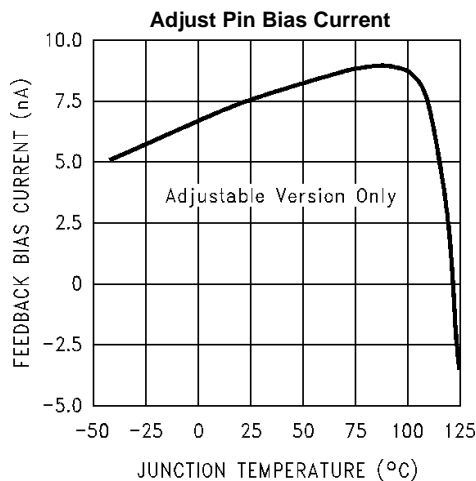
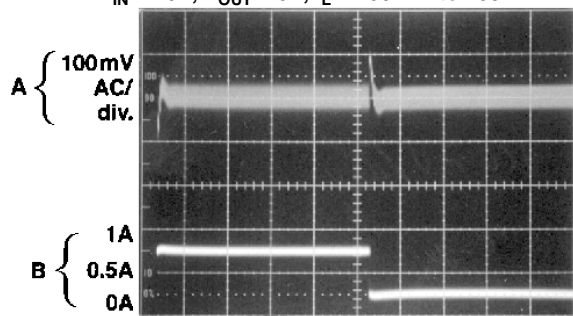

Figure 15.

Load Transient Response for Continuous Mode
 $V_{IN} = 20V$, $V_{OUT} = 5V$, $I_L = 250\text{ mA}$ to 750 mA



A: Output Voltage 100 mV/div (AC)
 B: 250 mA to 750 mA Load Pulse
 Horizontal Time Base: 200 μs /div

Load Transient Response for Discontinuous Mode
 $V_{IN} = 20V$, $V_{OUT} = 5V$, $I_L = 40\text{ mA}$ to 140 mA

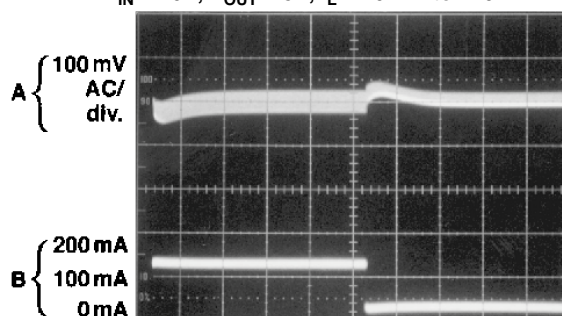

A: Output Voltage 100 mV/div (AC)
 B: 40 mA to 140 mA Load Pulse
 Horizontal Time Base: 200 μs /div

Figure 16. Typical Load Transient Response

Test Circuit

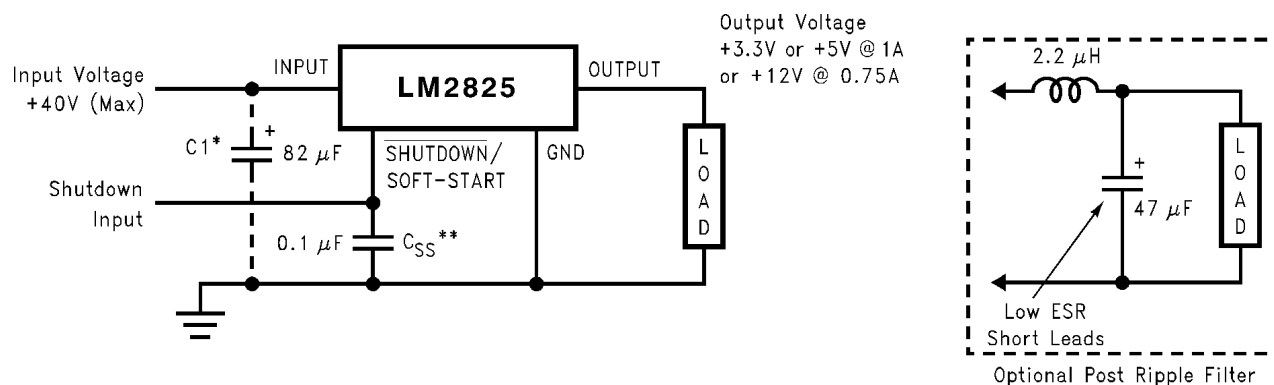

*Optional—Required if package is more than 6" away from main filter or bypass capacitor.

**Optional Soft-start Capacitor

$V_{IN} = 40V$ (max)

$V_{OUT} = 3.3V$ or $5V @ 1A$ or $12V @ 0.75A$

Figure 17. Standard Test Circuit (Fixed Output Voltage Versions)

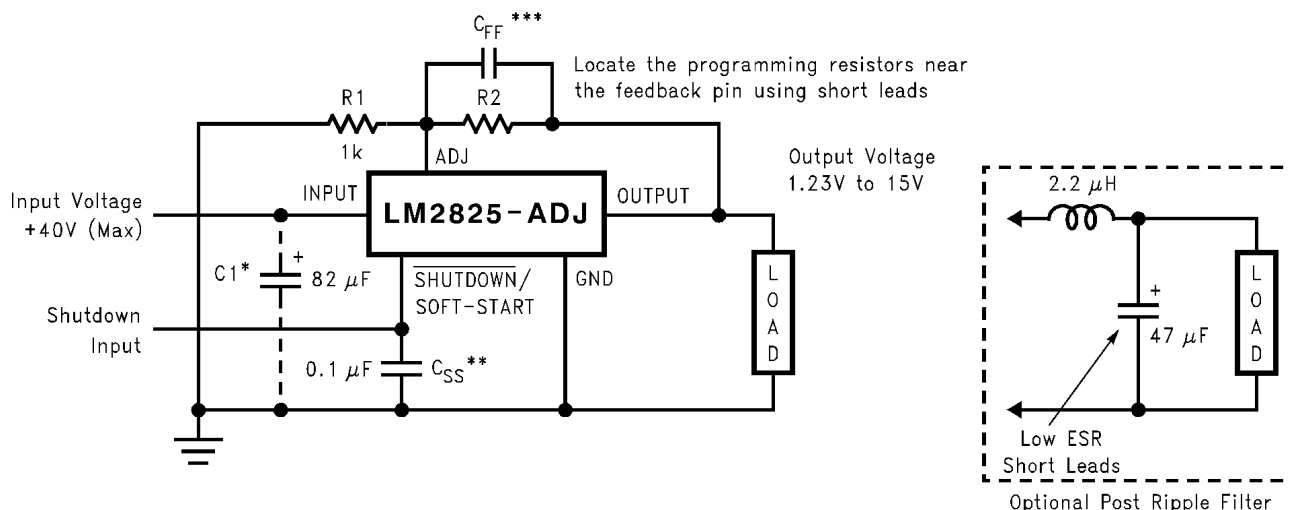

*Optional—Required if package is more than 6" away from main filter or bypass capacitor.

**Optional Soft-start Capacitor

***Optional—See [Application Information](#).

$V_{IN} = 40V$ (max)

$V_{OUT} = 1.23V$ to $8V$ (LM2825-ADJ)

$7V$ to $15V$ (LM2825H-ADJ)

$I_{LOAD} = I_{MAX}$ (See derating curves in [Application Information](#))

Figure 18. Standard Test Circuit (Adjustable Output Voltage Versions)

APPLICATION INFORMATION

PROGRAMMING OUTPUT VOLTAGE

(Selecting R1 and R2 as shown in [Figure 18](#))

The LM2825 is available in two adjustable output versions. The LM2825-ADJ has been optimized for output voltages between 1.23V and 8V, while the LM2825H-ADJ covers the output voltage range of 7V to 15V. Both adjustable versions are set in the following way.

$$V_{OUT} = V_{REF} \left(1 + \frac{R2}{R1} \right) \text{ where } V_{REF} = 1.23V \quad (1)$$

Select a value for R1 between 240Ω and 1.5 kΩ. The lower resistor values minimize noise pickup at the sensitive adjust pin. (For lowest temperature coefficient and the best stability with time, use 1% metal film resistors.)

Select R2 with the following equation.

$$R2 = R1 \left(\frac{V_{OUT}}{V_{REF}} - 1 \right) \quad (2)$$

When programming V_{OUT} , keep in mind that V_{IN} must be greater than $V_{OUT} + 2V$ for proper operation.

OPTIONAL EXTERNAL COMPONENTS

SOFT-START CAPACITOR

C_{SS}: A capacitor on this pin provides the regulator with a Soft-start feature (slow start-up). The current drawn from the source starts out at a low average level with narrow pulses, and ramps up in a controlled manner as the pulses expand to their steady-state width. This reduces the startup current considerably, and delays and slows down the output voltage rise time.

It is especially useful in situations where the input power source is limited in the amount of current it can deliver, since you avoid loading down this type of power supply.

Under some operating conditions, a Soft-start capacitor is required for proper operation. [Figure 19](#) indicates the input voltage and ambient temperature conditions for which a Soft-start capacitor may be required.

This curve is typical for full ensured output current and can be used as a guideline. As the output current decreases, the operating area requiring a Soft-start capacitor decreases. Capacitor values between 0.1 μF and 1 μF are recommended. Tantalum or ceramic capacitors are appropriate for this application.

INPUT CAPACITOR

C_{IN}: An optional input capacitor is required if the package is more than 6" away from the main filter or bypass capacitor. A low ESR aluminum or tantalum bypass capacitor is recommended between the input pin and ground to prevent large voltage transients from appearing at the input. In addition, to be conservative, the RMS current rating of the input capacitor should be selected to be at least ½ the DC load current. With a 1A load, a capacitor with a RMS current rating of at least 500 mA is recommended.

The voltage rating should be approximately 1.25 times the maximum input voltage. With a nominal input voltage of 12V, an aluminum electrolytic capacitor (Panasonic HFQ series or Nichicon PL series or equivalent) with a voltage rating greater than 15V ($1.25 \times V_{IN}$) would be needed.

Solid tantalum input capacitors should only be used where the input source is impedance current limited. High dV/dt applied at the input can cause excessive charge current through low ESR tantalum capacitors. This high charge current can result in shorting within the capacitor. It is recommended that they be surge current tested by the manufacturer. The TPS series available from AVX, and the 593D series from Sprague are both surge current tested.

Use caution when using ceramic capacitors for input bypassing, because it may cause ringing at the V_{IN} pin.

LOWERING OUTPUT RIPPLE

When using the adjustable parts, one can achieve lower output ripple voltage by shorting a resistor internal to the LM2825. However, if this resistor is shorted, a feed forward capacitor must be used to keep the regulator stable. For this reason, this resistor must be left open on all of the fixed output voltage versions or instability will result. See the [FEED FORWARD CAPACITOR SELECTION \(\$C_{FF}\$ \)](#) selection below. Shorting the internal resistor is accomplished by shorting pins 8 and 9 on the LM2825, and will typically reduce output ripple by 25 to 33%.

FEED FORWARD CAPACITOR SELECTION (C_{FF})

When using an adjustable part and pins 8 and 9 are shorted to reduce output ripple, a feed forward capacitor is required. This capacitor is typically between 680 pF and 2700 pF. [Table 1](#) shows the value for C_{FF} for a given output voltage and feedback resistor R_2 ($R_1 = 1 \text{ k}\Omega$).

Table 1. C_{FF} Selection Table

V_{OUT}	R_2	C_{FF}
LM2825-ADJ		
2	630	N/A
3	1.43k	N/A
4	2.26k	2700 pF
5	3.09k	2700 pF
6	3.92k	2200 pF
7	4.75k	1800 pF
8	5.49k	1500 pF
LM2825H-ADJ		
7	4.75k	2700 pF
8	5.49k	2200 pF
9	6.34k	1800 pF
10	7.15k	1500 pF
11	8.06k	1000 pF
12	8.87k	820 pF
13	9.53k	680 pF
14	10.5k	680 pF
15	11.3k	680 pF

SHUTDOWN

The circuit shown in [Figure 24](#) shows 2 circuits for the Shutdown/Soft-start feature using different logic signals for shutdown and using a 0.1 μF Soft-start capacitor.

THERMAL CONSIDERATIONS

The LM2825 is available in a 24-pin through hole PDIP. The package is molded plastic with a copper lead frame. When the package is soldered to the PC board, the copper and the board are the heat sink for the LM2825.

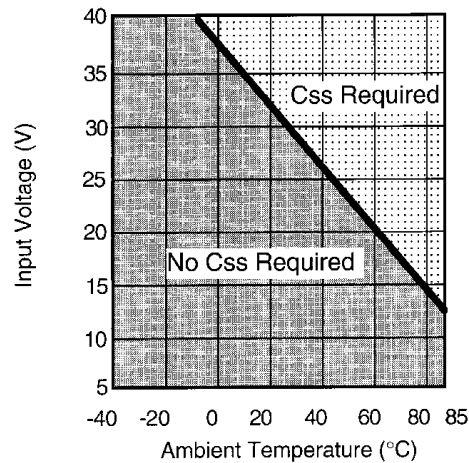

Figure 19. Usage of the Soft-start Capacitor

OUTPUT CURRENT DERATING FOR $T_J = -40^{\circ}\text{C}$ to -25°C AND $T_J = -25^{\circ}\text{C}$ to 0°C

At the lower temperature extremes, the switch current limit drops off sharply. As a result, a lower output current is available in this temperature range. See Figure 20 and Figure 21 for the typical available output current at these temperature ranges.

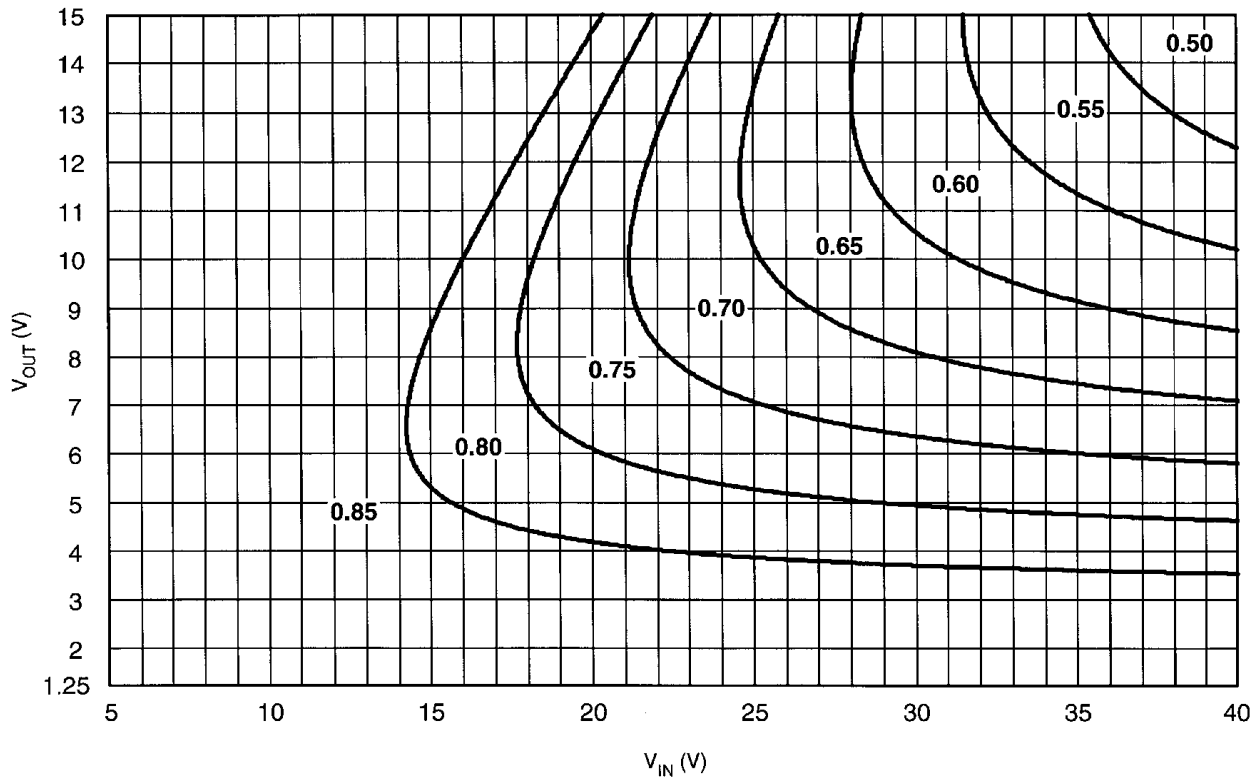

Figure 20. LM2825 Output Current Derating for $T_J = -40^{\circ}\text{C}$ to -25°C

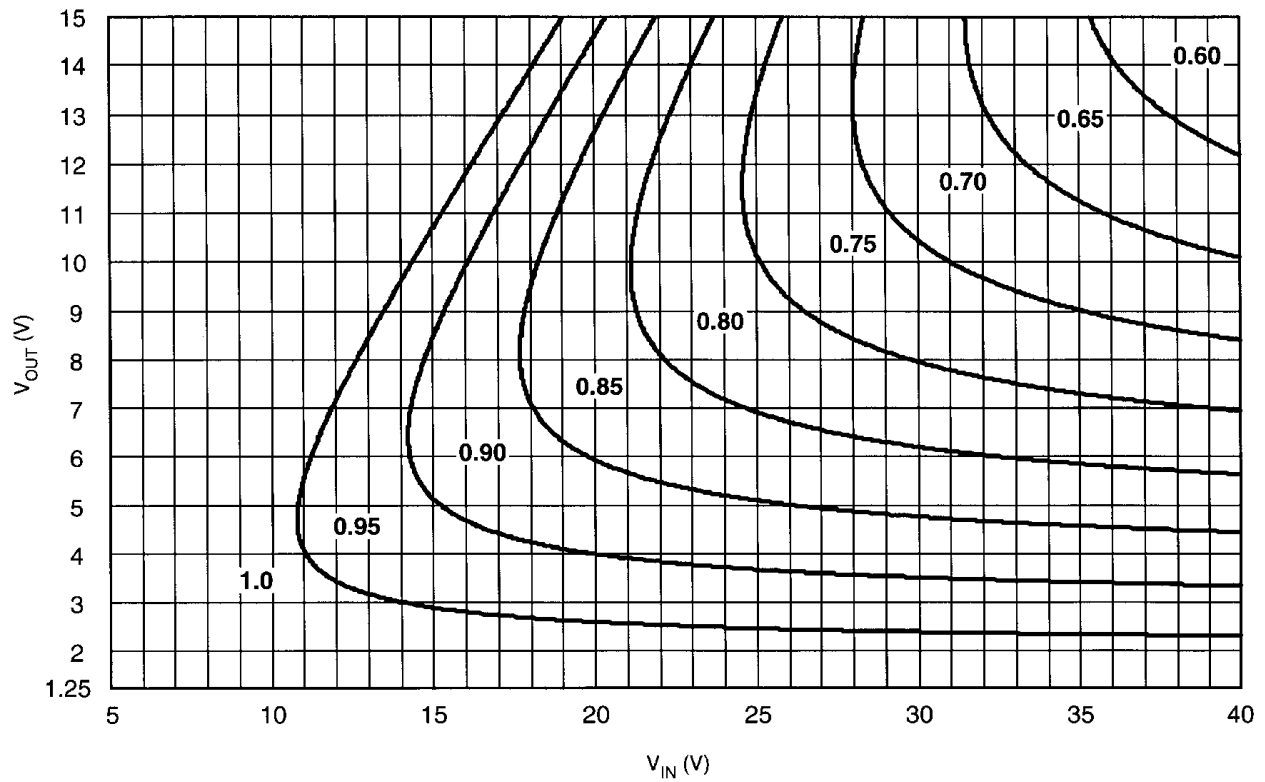

Figure 21. LM2825 Output Current Derating for $T_J = -25^\circ\text{C}$ to 0°C

OUTPUT CURRENT DERATING FOR $T_A = 0^\circ\text{C}$ to 70°C

Due to the limited switch current, the LM2825 cannot supply the full one ampere output current over the entire input and output voltage range. Figure 22 shows the typical available output current for any input and output voltage combination. This applies for all output voltage versions.

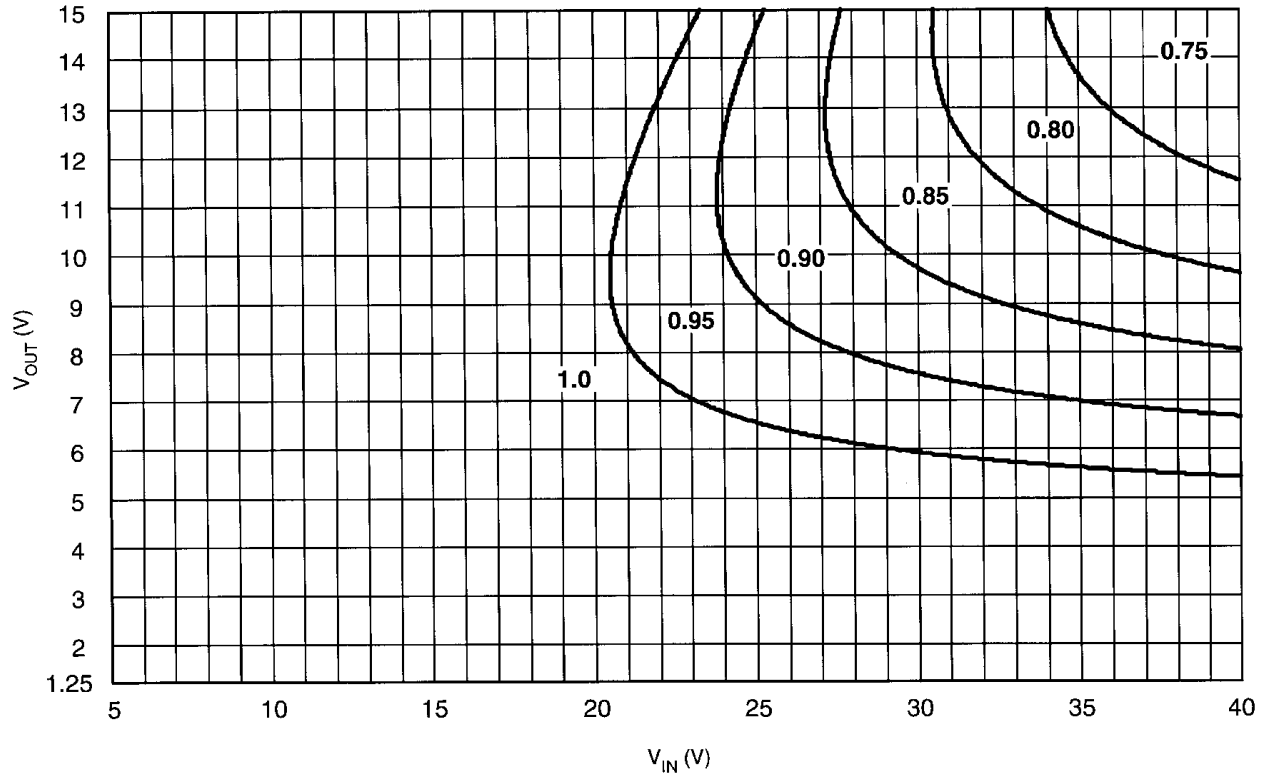

Figure 22. LM2825 Output Current Derating for $T_A = 0^\circ\text{C}$ to 70°C

OUTPUT CURRENT DERATING FOR $T_A = 70^\circ\text{C}$ to 85°C

At high these high ambient temperatures, the LM2825 cannot supply the full one ampere over the entire input and output voltage range. This is due to thermal reasons and Figure 23 shows the typical available output current for any input and output voltage combination. This applies for all output voltage versions.

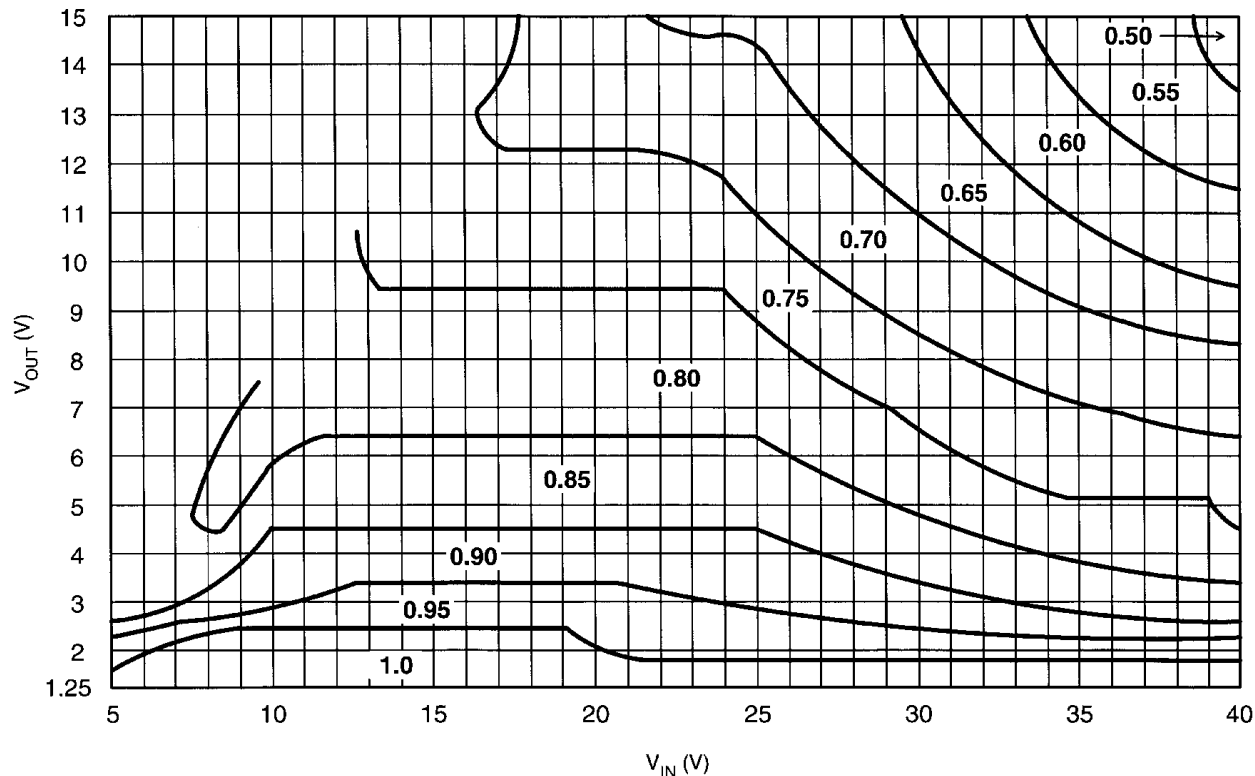

Figure 23. LM2825 Output Current Derating for $T_A = 70^\circ\text{C}$ to 85°C

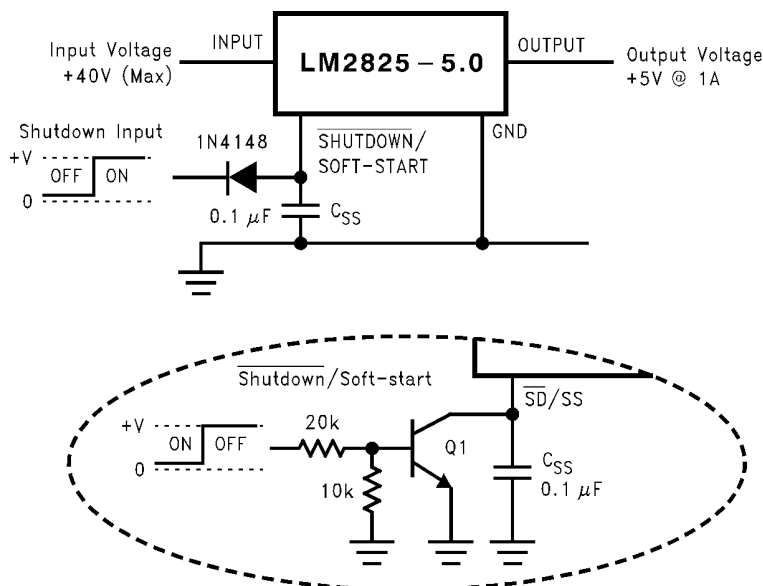
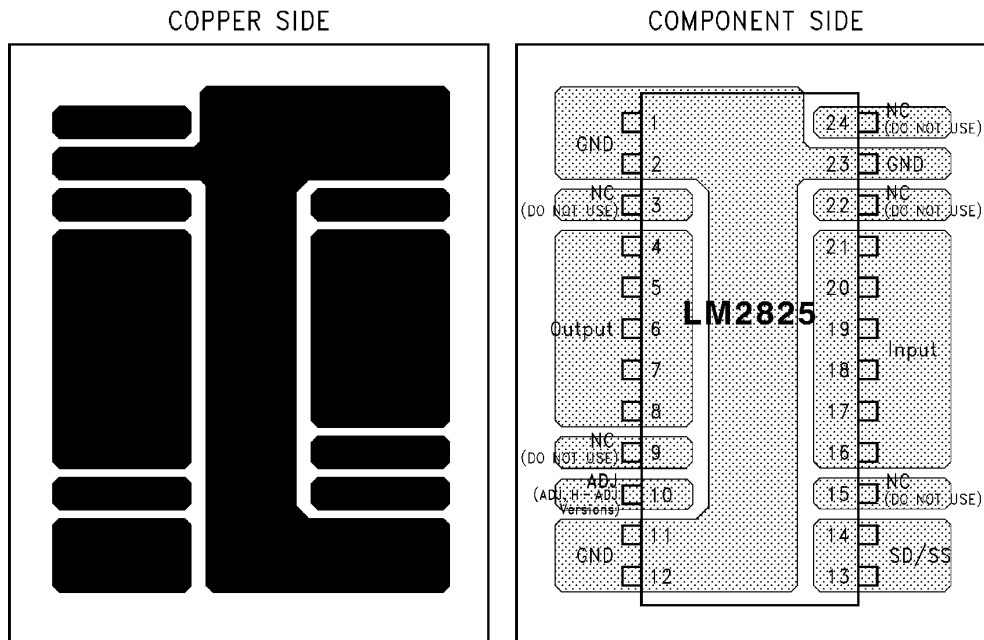

Figure 24. Typical Circuits Using Shutdown/Soft-start Features

**TYPICAL THROUGH HOLE PC BOARD LAYOUT (2X SIZE),
SINGLE SIDED, THROUGH HOLE PLATED**



Note: Holes are not shown.

"No Connect Pins" are connected to copper pads for thermal reasons only and must remain electrically isolated.

Figure 25. 2X Printed Circuit Board Layout

REVISION HISTORY

Changes from Revision B (April 2013) to Revision C	Page
• Changed layout of National Data Sheet to TI format	16

PACKAGING INFORMATION

Orderable Device	Status (1)	Package Type	Package Drawing	Pins	Package Qty	Eco Plan (2)	Lead/Ball Finish	MSL Peak Temp (3)	Op Temp (°C)	Device Marking (4/5)	Samples
LM2825HN-ADJ	ACTIVE	PDIP	NFL	24	12	TBD	Call TI	Call TI	-40 to 125	LM2825HN-ADJ ADJ, 1A OUTPUT	Samples
LM2825HN-ADJ/NOPB	ACTIVE	PDIP	NFL	24	12	Green (RoHS & no Sb/Br)	CU SN	Level-1-NA-UNLIM	-40 to 125	LM2825HN-ADJ ADJ, 1A OUTPUT	Samples
LM2825N-12	ACTIVE	PDIP	NFL	24		TBD	Call TI	Call TI	-40 to 125	LM2825N-12 12V, 1A OUTPUT	Samples
LM2825N-12/NOPB	ACTIVE	PDIP	NFL	24	12	Green (RoHS & no Sb/Br)	CU SN	Level-1-NA-UNLIM	-40 to 125	LM2825N-12 12V, 1A OUTPUT	Samples
LM2825N-3.3	ACTIVE	PDIP	NFL	24		TBD	Call TI	Call TI	-40 to 125	LM2825N-3.3 3.3V, 1A OUTPUT	Samples
LM2825N-3.3/NOPB	ACTIVE	PDIP	NFL	24	12	Green (RoHS & no Sb/Br)	CU SN	Level-1-NA-UNLIM	-40 to 125	LM2825N-3.3 3.3V, 1A OUTPUT	Samples
LM2825N-5.0	ACTIVE	PDIP	NFL	24	12	TBD	Call TI	Call TI	-40 to 125	LM2825N-5.0 5.0V, 1A OUTPUT	Samples
LM2825N-5.0/NOPB	ACTIVE	PDIP	NFL	24	12	Green (RoHS & no Sb/Br)	CU SN	Level-1-NA-UNLIM	-40 to 125	LM2825N-5.0 5.0V, 1A OUTPUT	Samples
LM2825N-ADJ	ACTIVE	PDIP	NFL	24	12	TBD	Call TI	Call TI	-40 to 125	LM2825N-ADJ ADJ, 1A OUTPUT	Samples
LM2825N-ADJ/NOPB	ACTIVE	PDIP	NFL	24	12	Green (RoHS & no Sb/Br)	CU SN	Level-1-NA-UNLIM	-40 to 125	LM2825N-ADJ ADJ, 1A OUTPUT	Samples

(1) The marketing status values are defined as follows:

ACTIVE: Product device recommended for new designs.

LIFEBUY: TI has announced that the device will be discontinued, and a lifetime-buy period is in effect.

NRND: Not recommended for new designs. Device is in production to support existing customers, but TI does not recommend using this part in a new design.

PREVIEW: Device has been announced but is not in production. Samples may or may not be available.

OBSOLETE: TI has discontinued the production of the device.

(2) Eco Plan - The planned eco-friendly classification: Pb-Free (RoHS), Pb-Free (RoHS Exempt), or Green (RoHS & no Sb/Br) - please check <http://www.ti.com/productcontent> for the latest availability information and additional product content details.

TBD: The Pb-Free/Green conversion plan has not been defined.

Pb-Free (RoHS): TI's terms "Lead-Free" or "Pb-Free" mean semiconductor products that are compatible with the current RoHS requirements for all 6 substances, including the requirement that lead not exceed 0.1% by weight in homogeneous materials. Where designed to be soldered at high temperatures, TI Pb-Free products are suitable for use in specified lead-free processes.

Pb-Free (RoHS Exempt): This component has a RoHS exemption for either 1) lead-based flip-chip solder bumps used between the die and package, or 2) lead-based die adhesive used between the die and leadframe. The component is otherwise considered Pb-Free (RoHS compatible) as defined above.

Green (RoHS & no Sb/Br): TI defines "Green" to mean Pb-Free (RoHS compatible), and free of Bromine (Br) and Antimony (Sb) based flame retardants (Br or Sb do not exceed 0.1% by weight in homogeneous material)

(3) MSL, Peak Temp. -- The Moisture Sensitivity Level rating according to the JEDEC industry standard classifications, and peak solder temperature.

(4) There may be additional marking, which relates to the logo, the lot trace code information, or the environmental category on the device.

(5) Multiple Device Markings will be inside parentheses. Only one Device Marking contained in parentheses and separated by a "~" will appear on a device. If a line is indented then it is a continuation of the previous line and the two combined represent the entire Device Marking for that device.

Important Information and Disclaimer:The information provided on this page represents TI's knowledge and belief as of the date that it is provided. TI bases its knowledge and belief on information provided by third parties, and makes no representation or warranty as to the accuracy of such information. Efforts are underway to better integrate information from third parties. TI has taken and continues to take reasonable steps to provide representative and accurate information but may not have conducted destructive testing or chemical analysis on incoming materials and chemicals. TI and TI suppliers consider certain information to be proprietary, and thus CAS numbers and other limited information may not be available for release.

In no event shall TI's liability arising out of such information exceed the total purchase price of the TI part(s) at issue in this document sold by TI to Customer on an annual basis.

NFL0024F

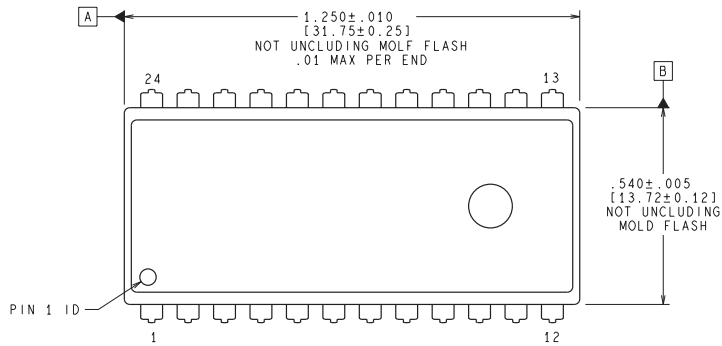

CONTROLLING DIMENSION IS INCH
 VALUES IN [] ARE MILLIMETERS
 DIMENSIONS IN () FOR REFERENCE ONLY

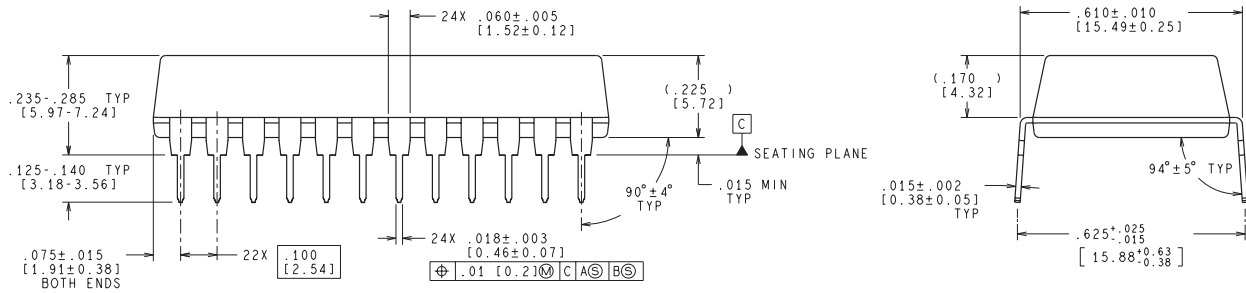

NA24F (Rev D)

IMPORTANT NOTICE

Texas Instruments Incorporated and its subsidiaries (TI) reserve the right to make corrections, enhancements, improvements and other changes to its semiconductor products and services per JESD46, latest issue, and to discontinue any product or service per JESD48, latest issue. Buyers should obtain the latest relevant information before placing orders and should verify that such information is current and complete. All semiconductor products (also referred to herein as "components") are sold subject to TI's terms and conditions of sale supplied at the time of order acknowledgment.

TI warrants performance of its components to the specifications applicable at the time of sale, in accordance with the warranty in TI's terms and conditions of sale of semiconductor products. Testing and other quality control techniques are used to the extent TI deems necessary to support this warranty. Except where mandated by applicable law, testing of all parameters of each component is not necessarily performed.

TI assumes no liability for applications assistance or the design of Buyers' products. Buyers are responsible for their products and applications using TI components. To minimize the risks associated with Buyers' products and applications, Buyers should provide adequate design and operating safeguards.

TI does not warrant or represent that any license, either express or implied, is granted under any patent right, copyright, mask work right, or other intellectual property right relating to any combination, machine, or process in which TI components or services are used. Information published by TI regarding third-party products or services does not constitute a license to use such products or services or a warranty or endorsement thereof. Use of such information may require a license from a third party under the patents or other intellectual property of the third party, or a license from TI under the patents or other intellectual property of TI.

Reproduction of significant portions of TI information in TI data books or data sheets is permissible only if reproduction is without alteration and is accompanied by all associated warranties, conditions, limitations, and notices. TI is not responsible or liable for such altered documentation. Information of third parties may be subject to additional restrictions.

Resale of TI components or services with statements different from or beyond the parameters stated by TI for that component or service voids all express and any implied warranties for the associated TI component or service and is an unfair and deceptive business practice. TI is not responsible or liable for any such statements.

Buyer acknowledges and agrees that it is solely responsible for compliance with all legal, regulatory and safety-related requirements concerning its products, and any use of TI components in its applications, notwithstanding any applications-related information or support that may be provided by TI. Buyer represents and agrees that it has all the necessary expertise to create and implement safeguards which anticipate dangerous consequences of failures, monitor failures and their consequences, lessen the likelihood of failures that might cause harm and take appropriate remedial actions. Buyer will fully indemnify TI and its representatives against any damages arising out of the use of any TI components in safety-critical applications.

In some cases, TI components may be promoted specifically to facilitate safety-related applications. With such components, TI's goal is to help enable customers to design and create their own end-product solutions that meet applicable functional safety standards and requirements. Nonetheless, such components are subject to these terms.

No TI components are authorized for use in FDA Class III (or similar life-critical medical equipment) unless authorized officers of the parties have executed a special agreement specifically governing such use.

Only those TI components which TI has specifically designated as military grade or "enhanced plastic" are designed and intended for use in military/aerospace applications or environments. Buyer acknowledges and agrees that any military or aerospace use of TI components which have **not** been so designated is solely at the Buyer's risk, and that Buyer is solely responsible for compliance with all legal and regulatory requirements in connection with such use.

TI has specifically designated certain components as meeting ISO/TS16949 requirements, mainly for automotive use. In any case of use of non-designated products, TI will not be responsible for any failure to meet ISO/TS16949.

Products

Audio	www.ti.com/audio
Amplifiers	amplifier.ti.com
Data Converters	dataconverter.ti.com
DLP® Products	www.dlp.com
DSP	dsp.ti.com
Clocks and Timers	www.ti.com/clocks
Interface	interface.ti.com
Logic	logic.ti.com
Power Mgmt	power.ti.com
Microcontrollers	microcontroller.ti.com
RFID	www.ti-rfid.com
OMAP Applications Processors	www.ti.com/omap
Wireless Connectivity	www.ti.com/wirelessconnectivity

Applications

Automotive and Transportation	www.ti.com/automotive
Communications and Telecom	www.ti.com/communications
Computers and Peripherals	www.ti.com/computers
Consumer Electronics	www.ti.com/consumer-apps
Energy and Lighting	www.ti.com/energy
Industrial	www.ti.com/industrial
Medical	www.ti.com/medical
Security	www.ti.com/security
Space, Avionics and Defense	www.ti.com/space-avionics-defense
Video and Imaging	www.ti.com/video

TI E2E Community

e2e.ti.com