

XLamp® XM-L2 EasyWhite® LEDs

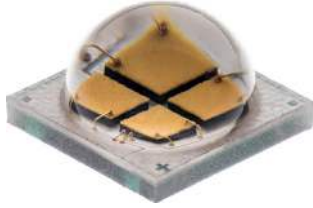

PRODUCT DESCRIPTION

The XLamp® XM-L2 EasyWhite® LED eliminates chromaticity binning and enables luminaire and bulb manufacturers to deliver the consistent color and high efficacy light output of a multi-die LED in the compact XM-L footprint. XLamp XM-L2 EasyWhite LEDs can reduce LED-to-LED color variation to within a 2-step MacAdam ellipse, 94% smaller than the total area of the corresponding ANSI C78.377 color region.

The XLamp XM-L2 EasyWhite LED is the perfect choice for lighting applications where high luminous flux output is required from a single, small point source. Example applications include LED retrofit bulbs, commercial/retail display spotlights, and other indoor general-illumination applications.

FEATURES

- Available in 4-step and 2-step EasyWhite bins at 2700 K, 3000 K, 3500 K, 4000 K, 5000 K CCT, ANSI white bins at 5700 K, 6500 K
- Wide range of operating current – up to 2 A @ 6 V or 1 A @ 12 V
- 85 °C binning and characterization
- Available in 6-V and 12-V versions
- Low thermal resistance: 1 °C/W
- Wide viewing angle: 115°
- Wide variety of CRI choices: standard CRI as well as 80- & 90-minimum CRI
- Electrically neutral thermal path
- Unlimited floor life at ≤ 30 °C/85% RH
- Reflow solderable - JEDEC J-STD-020C
- RoHS and REACH compliant
- UL® recognized component (E349212)

TABLE OF CONTENTS

Characteristics	2
Flux Characteristics, Standard Order Codes and Bins, 6-V XM-L2 EZW	3
Flux Characteristics, ANSI Order Codes and Bins, 6-V XM-L2 EZW	5
Flux Characteristics, Standard Order Codes and Bins, 12-V XM-L2 EZW	6
Flux Characteristics, ANSI Order Codes and Bins, 12-V XM-L2 EZW	8
Relative Spectral Power Distribution	9
Relative Flux vs. Junction Temperature.....	9
Electrical Characteristics.....	10
Relative Flux vs. Current	11
Relative Chromaticity vs. Current and Temperature	12
Typical Spatial Distribution.....	13
Thermal Design	13
Performance Groups – Brightness	14
Performance Groups – Chromaticity.....	14
EasyWhite® Bins Plotted on the 1931 CIE Color Space	15
Standard Cool White Kits Plotted on ANSI Standard Chromaticity Regions	16
ANSI White Bins Plotted on the 1931 CIE Color Space	16
Bin and Order Code Formats	17
Reflow Soldering Characteristics.....	18
Notes	19
Mechanical Dimensions	21
Tape and Reel.....	22
Packaging.....	24



CHARACTERISTICS

Characteristics	Unit	Minimum	Typical	Maximum
Thermal resistance, junction to solder point [⊠]	°C/W		1	
Viewing angle (FWHM)	degrees		115	
Temperature coefficient of voltage (6 V)	mV/°C		-3	
Temperature coefficient of voltage (12 V)	mV/°C		-6	
ESD withstand voltage (HBM per Mil-Std-883D)	V			8000
DC forward current (6 V)	mA			2000
DC forward current (12 V)	mA			1000
Reverse current (6 V, 12 V)	mA			1
Forward voltage (@ 700 mA, 85 °C, 6 V)	V		5.7	6.2
Forward voltage (@ 350 mA, 85 °C, 12 V)	V		11.3	12.4
LED junction temperature	°C			150

Note:

- ⊠ Thermal resistance measurement was performed per the JEDEC JESD51-14 standard. See the [Thermal Resistance Measurement application note](#) for more details.

FLUX CHARACTERISTICS, STANDARD ORDER CODES AND BINS, 6-V XM-L2 EZW (700 mA, T_J = 85 °C)

The following table provides the order codes for 6-volt XLamp XM-L2 EZW LEDs. For a complete description of the order code nomenclature, please see the Bin and Order Code Formats section (page 17).

Color	CCT Range	Minimum Luminous Flux @ 700 mA			2-Step		4-Step	
		Group	Flux (lm) @ 85 °C	Flux (lm) @ 25 °C*	Chromaticity Region	Order Code	Chromaticity Region	Order Code
Standard CRI EasyWhite	5000 K	V2	400	466	50H	XMLBEZ-00-0000-0B00V250H	50F	XMLBEZ-00-0000-0B00V250F
		V3	420	486		XMLBEZ-00-0000-0B00V350H		XMLBEZ-00-0000-0B00V350F
		V4	440	513		XMLBEZ-00-0000-0B00V450H		XMLBEZ-00-0000-0B00V450F
	4000 K	U6	380	443	40H	XMLBEZ-00-0000-0B00U640H	40F	XMLBEZ-00-0000-0B00U640F
		V2	400	466		XMLBEZ-00-0000-0B00V240H		XMLBEZ-00-0000-0B00V240F
		V3	420	486		XMLBEZ-00-0000-0B00V340H		XMLBEZ-00-0000-0B00V340F
		V4	440	513		XMLBEZ-00-0000-0B00V440H		XMLBEZ-00-0000-0B00V440F
	3500 K	U5	360	420	35H	XMLBEZ-00-0000-0B00U535H	35F	XMLBEZ-00-0000-0B00U535F
		U6	380	443		XMLBEZ-00-0000-0B00U635H		XMLBEZ-00-0000-0B00U635F
		V2	400	466		XMLBEZ-00-0000-0B00V235H		XMLBEZ-00-0000-0B00V235F
		V3	420	486		XMLBEZ-00-0000-0B00V335H		XMLBEZ-00-0000-0B00V335F
	3000 K	U5	360	420	30H	XMLBEZ-00-0000-0B00U530H	30F	XMLBEZ-00-0000-0B00U530F
		U6	380	443		XMLBEZ-00-0000-0B00U630H		XMLBEZ-00-0000-0B00U630F
		V2	400	466		XMLBEZ-00-0000-0B00V230H		XMLBEZ-00-0000-0B00V230F
	2700 K	U5	360	420	27H	XMLBEZ-00-0000-0B00U527H	27F	XMLBEZ-00-0000-0B00U527F
		U6	380	443		XMLBEZ-00-0000-0B00U627H		XMLBEZ-00-0000-0B00U627F

Notes

- Cree LED maintains a tolerance of ±7% on flux and power measurements, ±0.005 on chromaticity (CCx, CCy) measurements and a tolerance of ±2 on CRI measurements. See the Measurements section (page 19).
- For Standard CRI parts, typical CRI is 75 for 5000 - 4000-K CCT parts, 80 for 4000 - 3500-K CCT parts and 82 for 3000 - 2700-K CCT parts.
- * Flux values @ 25 °C are calculated and for reference only.

FLUX CHARACTERISTICS, STANDARD ORDER CODES AND BINS, 6-V XM-L2 EZW (700 mA, T_j = 85 °C) - CONTINUED

Color	CCT Range	Minimum Luminous Flux @ 700 mA			2-Step		4-Step		
		Group	Flux (lm) @ 85 °C	Flux (lm) @ 25 °C*	Chromaticity Region	Order Code	Chromaticity Region	Order Code	
80-CRI Minimum EasyWhite	5000 K	U6	380	443	50H	XMLBEZ-00-0000-0B0HU650H	50F	XMLBEZ-00-0000-0B0HU650F	
		V2	400	466		XMLBEZ-00-0000-0B0HV250H		XMLBEZ-00-0000-0B0HV250F	
		V3	420	486		XMLBEZ-00-0000-0B0HV350H		XMLBEZ-00-0000-0B0HV350F	
	4000 K	U6	380	443	40H	XMLBEZ-00-0000-0B0HU640H	40F	XMLBEZ-00-0000-0B0HU640F	
		V2	400	466		XMLBEZ-00-0000-0B0HV240H		XMLBEZ-00-0000-0B0HV240F	
		V3	420	486		XMLBEZ-00-0000-0B0HV340H		XMLBEZ-00-0000-0B0HV340F	
	3500 K	U5	360	420	35H	XMLBEZ-00-0000-0B0HU535H	35F	XMLBEZ-00-0000-0B0HU535F	
		U6	380	443		XMLBEZ-00-0000-0B0HU635H		XMLBEZ-00-0000-0B0HU635F	
		V2	400	466		XMLBEZ-00-0000-0B0HV235H		XMLBEZ-00-0000-0B0HV235F	
		V3	420	486		XMLBEZ-00-0000-0B0HV335H		XMLBEZ-00-0000-0B0HV335F	
	3000 K	U4	340	396	30H	XMLBEZ-00-0000-0B0HU430H	30F	XMLBEZ-00-0000-0B0HU430F	
		U5	380	443		XMLBEZ-00-0000-0B0HU530H		XMLBEZ-00-0000-0B0HU530F	
		U6	380	443		XMLBEZ-00-0000-0B0HU630H		XMLBEZ-00-0000-0B0HU630F	
		V2	400	466		XMLBEZ-00-0000-0B0HV230H		XMLBEZ-00-0000-0B0HV230F	
	2700 K	U4	340	396	27H	XMLBEZ-00-0000-0B0HU427H	27F	XMLBEZ-00-0000-0B0HU427F	
		U5	380	443		XMLBEZ-00-0000-0B0HU527H		XMLBEZ-00-0000-0B0HU527F	
		U6	380	443		XMLBEZ-00-0000-0B0HU627H		XMLBEZ-00-0000-0B0HU627F	
	90-CRI Minimum EasyWhite	3000 K	T4	240	280	30H	XMLBEZ-00-0000-0B0UT430H	30F	XMLBEZ-00-0000-0B0UT430F
			T5	260	303		XMLBEZ-00-0000-0B0UT530H		XMLBEZ-00-0000-0B0UT530F
			T6	280	326		XMLBEZ-00-0000-0B0UT630H		XMLBEZ-00-0000-0B0UT630F
		2700 K	T4	240	280	27H	XMLBEZ-00-0000-0B0UT427H	27F	XMLBEZ-00-0000-0B0UT427F
T5			260	303	XMLBEZ-00-0000-0B0UT527H		XMLBEZ-00-0000-0B0UT527F		
T6			280	326	XMLBEZ-00-0000-0B0UT627H		XMLBEZ-00-0000-0B0UT627F		

Notes

- Cree LED maintains a tolerance of ±7% on flux and power measurements, ±0.005 on chromaticity (CCx, CCy) measurements and a tolerance of ±2 on CRI measurements. See the Measurements section (page 19).
- For Standard CRI parts, typical CRI is 75 for 5000 - 4000-K CCT parts, 80 for 4000 - 3500-K CCT parts and 82 for 3000 - 2700-K CCT parts.
- * Flux values @ 25 °C are calculated and for reference only.

FLUX CHARACTERISTICS, ANSI ORDER CODES AND BINS, 6-V XM-L2 EZW (700 mA, T_j = 85 °C)

Color	CCT Range	Minimum Luminous Flux @ 700 mA			Chromaticity Regions	Order Code
		Group	Flux (lm) @ 85 °C	Flux (lm) @ 25 °C*		
Standard CRI ANSI White	6500 K	V2	400	466	0E1	XMLBEZ-00-0000-0B00V20E1
		V3	420	486		XMLBEZ-00-0000-0B00V30E1
		V4	440	513		XMLBEZ-00-0000-0B00V40E1
	5700 K	V2	400	466	0E2	XMLBEZ-00-0000-0B00V20E2
		V3	420	486		XMLBEZ-00-0000-0B00V30E2
		V4	440	513		XMLBEZ-00-0000-0B00V40E2
80-CRI Minimum ANSI White	6500 K	U6	380	443	0E1	XMLBEZ-00-0000-0B0HU60E1
		V2	400	466		XMLBEZ-00-0000-0B0HV20E1
		V3	420	486		XMLBEZ-00-0000-0B0HV30E1
	5700 K	U6	380	443	0E2	XMLBEZ-00-0000-0B0HU60E2
		V2	400	466		XMLBEZ-00-0000-0B0HV20E2
		V3	420	486		XMLBEZ-00-0000-0B0HV30E2

Notes

- Cree LED maintains a tolerance of ±7% on flux and power measurements, ±0.005 on chromaticity (CCx, CCy) measurements and a tolerance of ±2 on CRI measurements. See the Measurements section (page 19).
- For Standard CRI parts, typical CRI is 75 for 5000 - 4000-K CCT parts, 80 for 4000 - 3500-K CCT parts and 82 for 3000 - 2700-K CCT parts.
- * Flux values @ 25 °C are calculated and for reference only.

FLUX CHARACTERISTICS, STANDARD ORDER CODES AND BINS, 12-V XM-L2 EZW (350 mA, T_j = 85 °C)

The following table provides the order codes for 12-volt XLamp XM-L2 EZW LEDs. For a complete description of the order code nomenclature, please see the Bin and Order Code Formats section (page 17).

Color	CCT Range	Minimum Luminous Flux @ 350 mA			2-Step		4-Step	
		Group	Flux (lm) @ 85 °C	Flux (lm) @ 25 °C*	Chromaticity Region	Order Code	Chromaticity Region	Order Code
Standard CRI EasyWhite	5000 K	V2	400	466	50H	XMLBEZ-00-0000-0D00V250H	50F	XMLBEZ-00-0000-0D00V250F
		V3	420	486		XMLBEZ-00-0000-0D00V350H		XMLBEZ-00-0000-0D00V350F
		V4	440	513		XMLBEZ-00-0000-0D00V450H		XMLBEZ-00-0000-0D00V450F
	4000 K	U6	380	443	40H	XMLBEZ-00-0000-0D00U640H	40F	XMLBEZ-00-0000-0D00U640F
		V2	400	466		XMLBEZ-00-0000-0D00V240H		XMLBEZ-00-0000-0D00V240F
		V3	420	486		XMLBEZ-00-0000-0D00V340H		XMLBEZ-00-0000-0D00V340F
		V4	440	513		XMLBEZ-00-0000-0D00V440H		XMLBEZ-00-0000-0D00V440F
	3500 K	U5	360	420	35H	XMLBEZ-00-0000-0D00U535H	35F	XMLBEZ-00-0000-0D00U535F
		U6	380	443		XMLBEZ-00-0000-0D00U635H		XMLBEZ-00-0000-0D00U635F
		V2	400	466		XMLBEZ-00-0000-0D00V235H		XMLBEZ-00-0000-0D00V235F
		V3	420	486		XMLBEZ-00-0000-0D00V335H		XMLBEZ-00-0000-0D00V335F
	3000 K	U5	360	420	30H	XMLBEZ-00-0000-0D00U530H	30F	XMLBEZ-00-0000-0D00U530F
		U6	380	443		XMLBEZ-00-0000-0D00U630H		XMLBEZ-00-0000-0D00U630F
		V2	400	466		XMLBEZ-00-0000-0D00V230H		XMLBEZ-00-0000-0D00V230F
	2700 K	U5	360	420	27H	XMLBEZ-00-0000-0D00U527H	27F	XMLBEZ-00-0000-0D00U527F
		U6	380	443		XMLBEZ-00-0000-0D00U627H		XMLBEZ-00-0000-0D00U627F

Notes

- Cree LED maintains a tolerance of ±7% on flux and power measurements, ±0.005 on chromaticity (CCx, CCy) measurements and a tolerance of ±2 on CRI measurements. See the Measurements section (page 19).
- For Standard CRI parts, typical CRI is 75 for 5000 - 4000-K CCT parts, 80 for 4000 - 3500-K CCT parts and 82 for 3000 - 2700-K CCT parts.
- * Flux values @ 25 °C are calculated and for reference only.

FLUX CHARACTERISTICS, STANDARD ORDER CODES AND BINS, 12-V XM-L2 EZW (350 mA, T_j = 85 °C) - CONTINUED

Color	CCT Range	Minimum Luminous Flux @ 350 mA			2-Step		4-Step		
		Group	Flux (lm) @ 85 °C	Flux (lm) @ 25 °C*	Chromaticity Region	Order Code	Chromaticity Region	Order Code	
80-CRI Minimum EasyWhite	5000 K	U6	380	443	50H	XMLBEZ-00-0000-0D0HU650H	50F	XMLBEZ-00-0000-0D0HU650F	
		V2	400	466		XMLBEZ-00-0000-0D0HV250H		XMLBEZ-00-0000-0D0HV250F	
		V3	420	486		XMLBEZ-00-0000-0D0HV350H		XMLBEZ-00-0000-0D0HV350F	
	4000 K	U6	380	443	40H	XMLBEZ-00-0000-0D0HU640H	40F	XMLBEZ-00-0000-0D0HU640F	
		V2	400	466		XMLBEZ-00-0000-0D0HV240H		XMLBEZ-00-0000-0D0HV240F	
		V3	420	486		XMLBEZ-00-0000-0D0HV340H		XMLBEZ-00-0000-0D0HV340F	
	3500 K	U5	360	420	35H	XMLBEZ-00-0000-0D0HU535H	35F	XMLBEZ-00-0000-0D0HU535F	
		U6	380	443		XMLBEZ-00-0000-0D0HU635H		XMLBEZ-00-0000-0D0HU635F	
		V2	400	466		XMLBEZ-00-0000-0D0HV235H		XMLBEZ-00-0000-0D0HV235F	
		V3	420	486		XMLBEZ-00-0000-0D0HV335H		XMLBEZ-00-0000-0D0HV335F	
	3000 K	U4	340	396	30H	XMLBEZ-00-0000-0D0HU430H	30F	XMLBEZ-00-0000-0D0HU430F	
		U5	380	443		XMLBEZ-00-0000-0D0HU530H		XMLBEZ-00-0000-0D0HU530F	
		U6	380	443		XMLBEZ-00-0000-0D0HU630H		XMLBEZ-00-0000-0D0HU630F	
		V2	400	466		XMLBEZ-00-0000-0D0HV230H		XMLBEZ-00-0000-0D0HV230F	
	2700 K	U4	340	396	27H	XMLBEZ-00-0000-0D0HU427H	27F	XMLBEZ-00-0000-0D0HU427F	
		U5	380	443		XMLBEZ-00-0000-0D0HU527H		XMLBEZ-00-0000-0D0HU527F	
		U6	380	443		XMLBEZ-00-0000-0D0HU627H		XMLBEZ-00-0000-0D0HU627F	
	90-CRI Minimum EasyWhite	3000 K	T4	240	280	30H	XMLBEZ-00-0000-0D0UT430H	30F	XMLBEZ-00-0000-0D0UT430F
			T5	260	303		XMLBEZ-00-0000-0D0UT530H		XMLBEZ-00-0000-0D0UT530F
			T6	280	326		XMLBEZ-00-0000-0D0UT630H		XMLBEZ-00-0000-0D0UT630F
		2700 K	T4	240	280	27H	XMLBEZ-00-0000-0D0UT427H	27F	XMLBEZ-00-0000-0D0UT427F
			T5	260	303		XMLBEZ-00-0000-0D0UT527H		XMLBEZ-00-0000-0D0UT527F
			T6	280	326		XMLBEZ-00-0000-0D0UT627H		XMLBEZ-00-0000-0D0UT627F

Notes

- Cree LED maintains a tolerance of ±7% on flux and power measurements, ±0.005 on chromaticity (CCx, CCy) measurements and a tolerance of ±2 on CRI measurements. See the Measurements section (page 19).
- For Standard CRI parts, typical CRI is 75 for 5000 - 4000-K CCT parts, 80 for 4000 - 3500-K CCT parts and 82 for 3000 - 2700-K CCT parts.
- * Flux values @ 25 °C are calculated and for reference only.

FLUX CHARACTERISTICS, ANSI ORDER CODES AND BINS, 12-V XM-L2 EZW (350 mA, T_J = 85 °C)

Color	CCT Range	Minimum Luminous Flux @ 350 mA			Chromaticity Regions	Order Code
		Group	Flux (lm) @ 85 °C	Flux (lm) @ 25 °C*		
Standard CRI ANSI White	6500 K	V2	400	466	0E1	XMLBEZ-00-0000-0D00V20E1
		V3	420	486		XMLBEZ-00-0000-0D00V30E1
		V4	440	513		XMLBEZ-00-0000-0D00V40E1
	5700 K	V2	400	466	0E2	XMLBEZ-00-0000-0D00V20E2
		V3	420	486		XMLBEZ-00-0000-0D00V30E2
		V4	440	513		XMLBEZ-00-0000-0D00V40E2
80-CRI Minimum ANSI White	6500 K	U6	380	443	0E1	XMLBEZ-00-0000-0D0HU60E1
		V2	400	466		XMLBEZ-00-0000-0D0HV20E1
		V3	420	486		XMLBEZ-00-0000-0D0HV30E1
	5700 K	U6	380	443	0E2	XMLBEZ-00-0000-0D0HU60E2
		V2	400	466		XMLBEZ-00-0000-0D0HV20E2
		V3	420	486		XMLBEZ-00-0000-0D0HV30E2

Notes

- Cree LED maintains a tolerance of $\pm 7\%$ on flux and power measurements, ± 0.005 on chromaticity (CCx, CCy) measurements and a tolerance of ± 2 on CRI measurements. See the Measurements section (page 19).
- For Standard CRI parts, typical CRI is 75 for 5000 - 4000-K CCT parts, 80 for 4000 - 3500-K CCT parts and 82 for 3000 - 2700-K CCT parts.
- * Flux values @ 25 °C are calculated and for reference only.

RELATIVE SPECTRAL POWER DISTRIBUTION

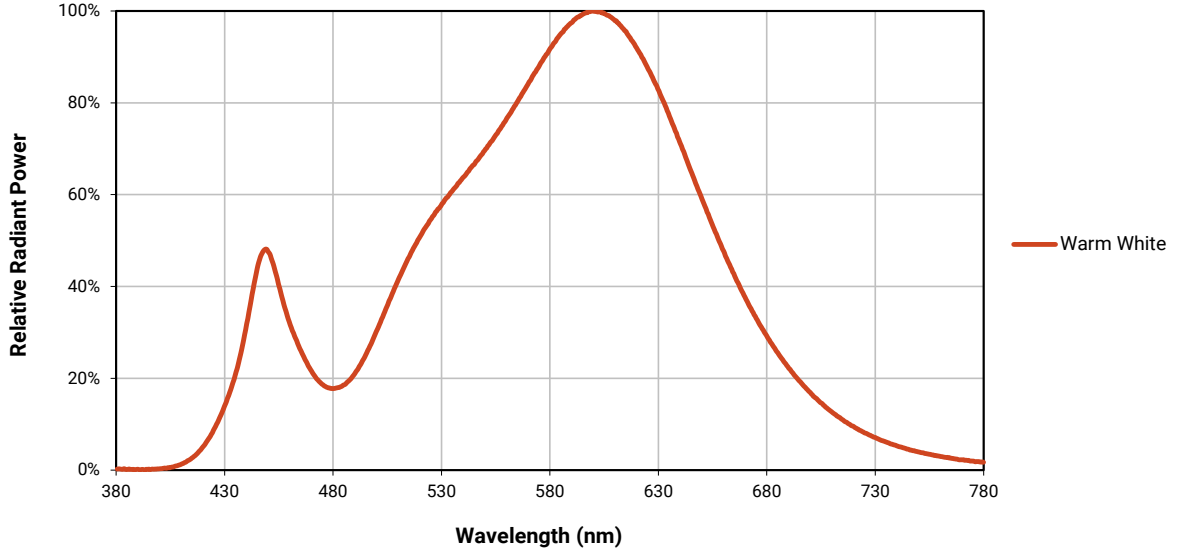

RELATIVE FLUX VS. JUNCTION TEMPERATURE (6-V - I_F = 700 mA; 12-V - I_F = 350 mA)

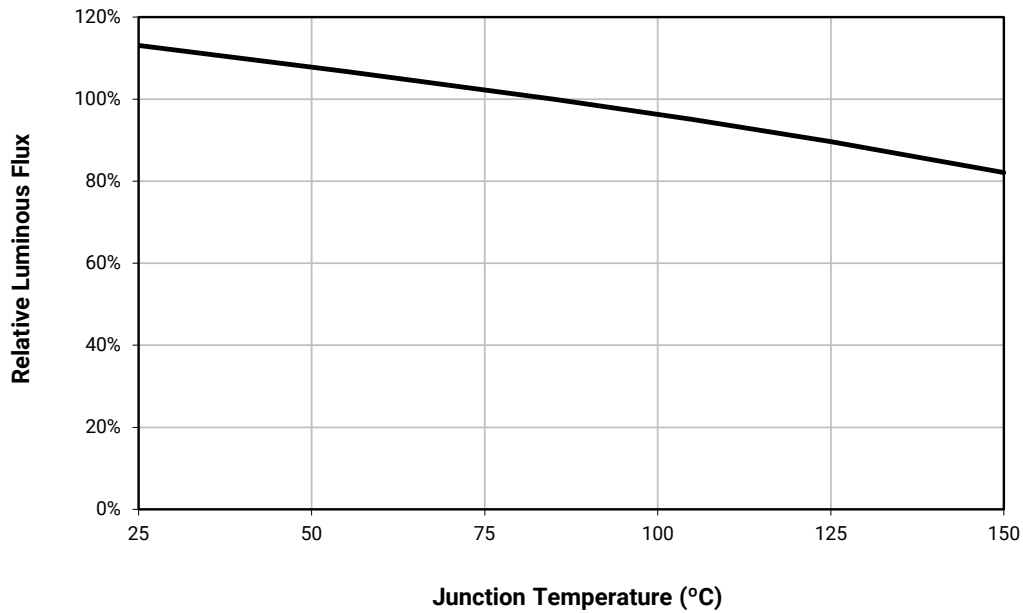

ELECTRICAL CHARACTERISTICS ($T_j = 85\text{ }^\circ\text{C}$)

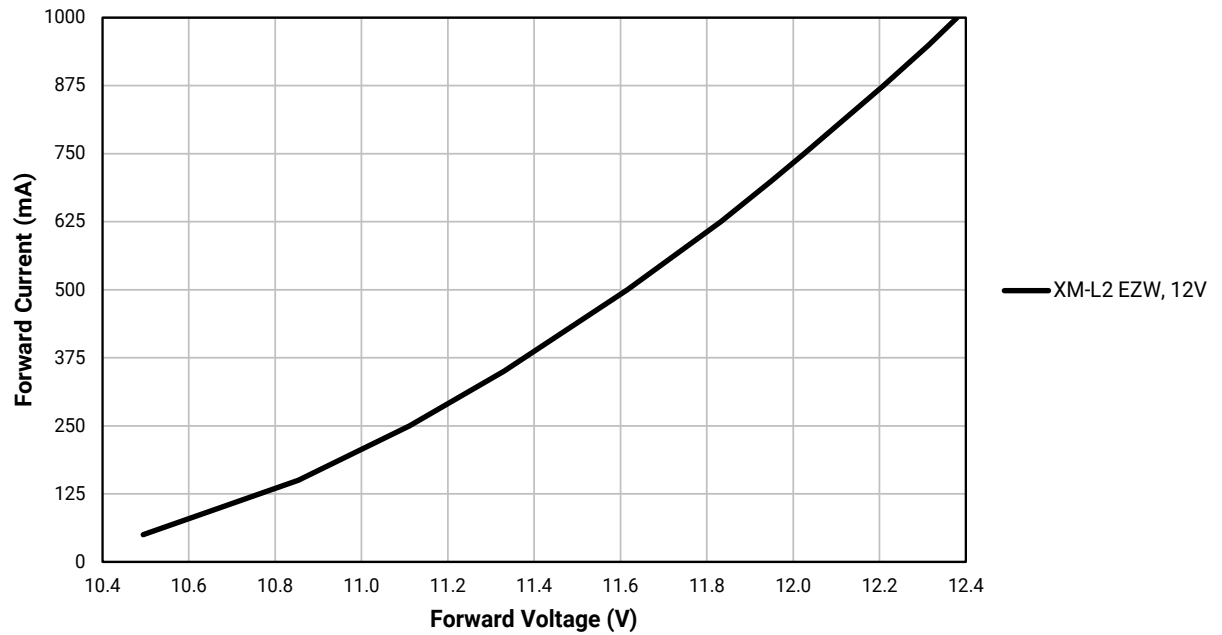
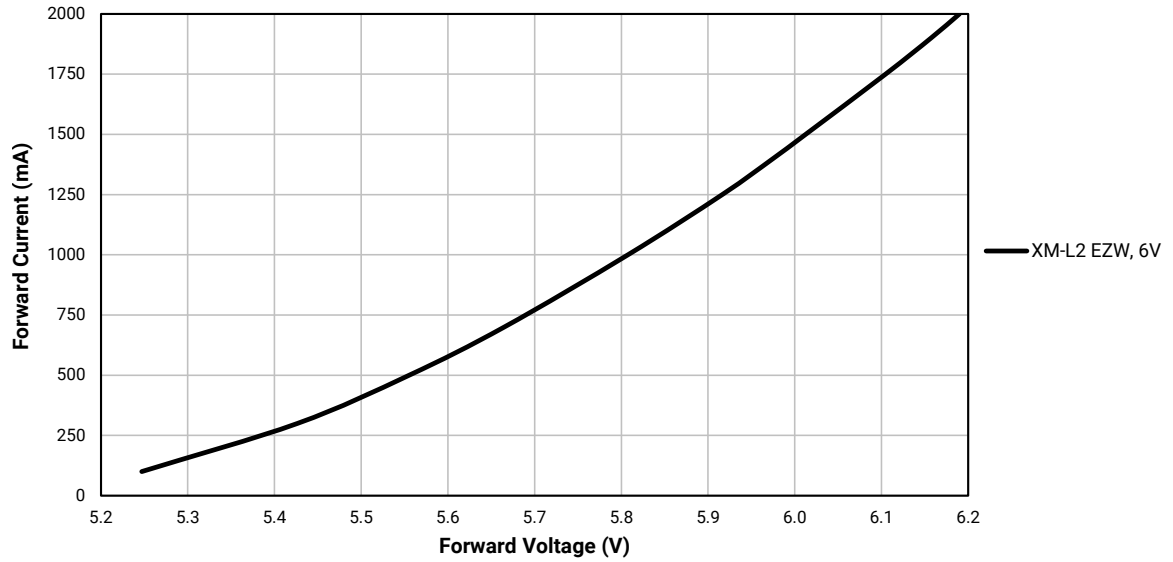

RELATIVE FLUX VS. CURRENT ($T_j = 85^\circ\text{C}$)

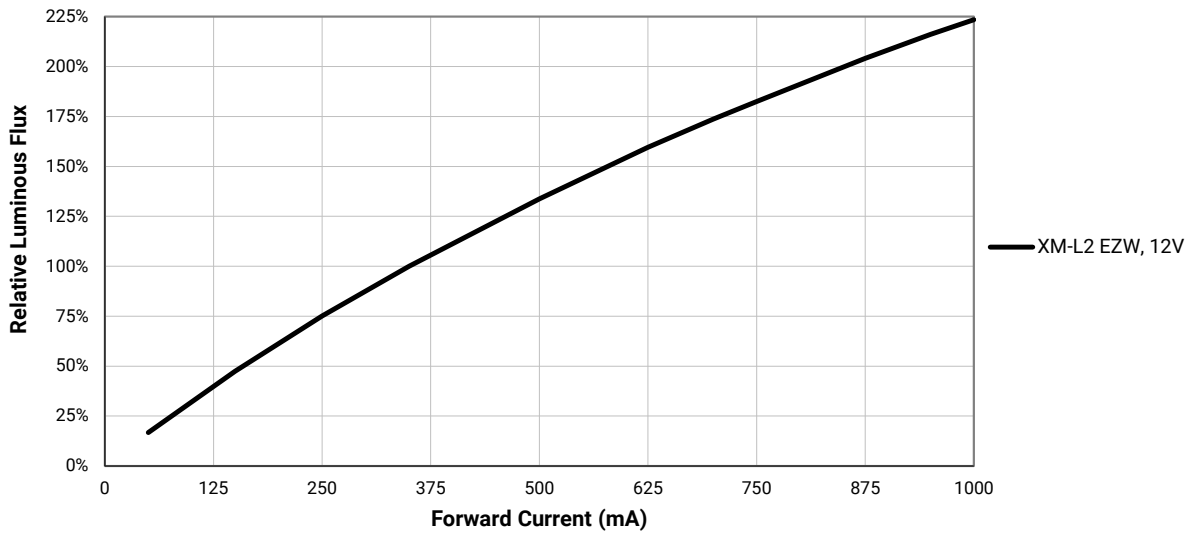
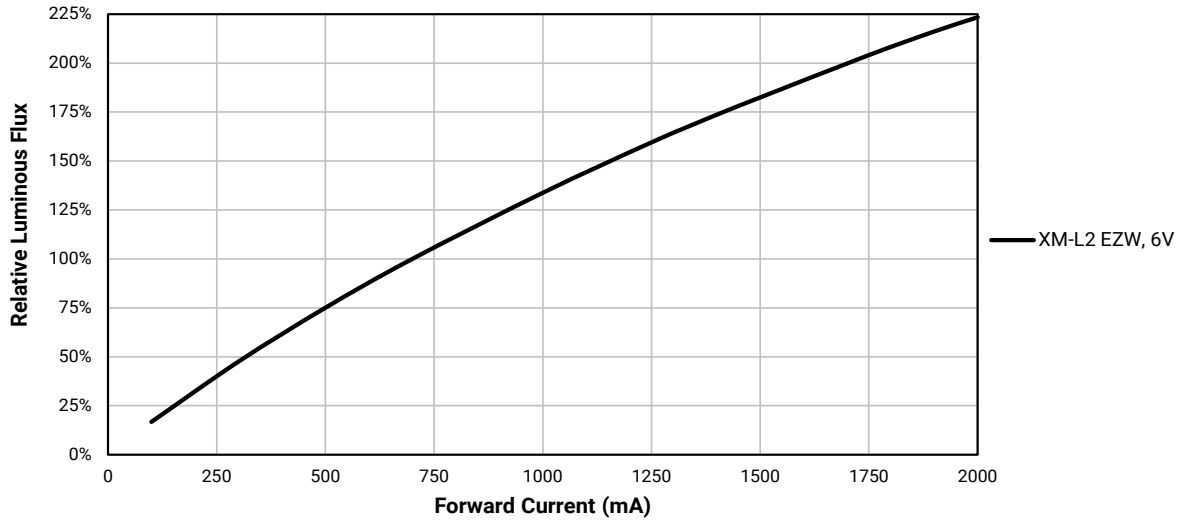

RELATIVE CHROMATICITY VS. CURRENT AND TEMPERATURE

XM-L2 EZW, 6 V

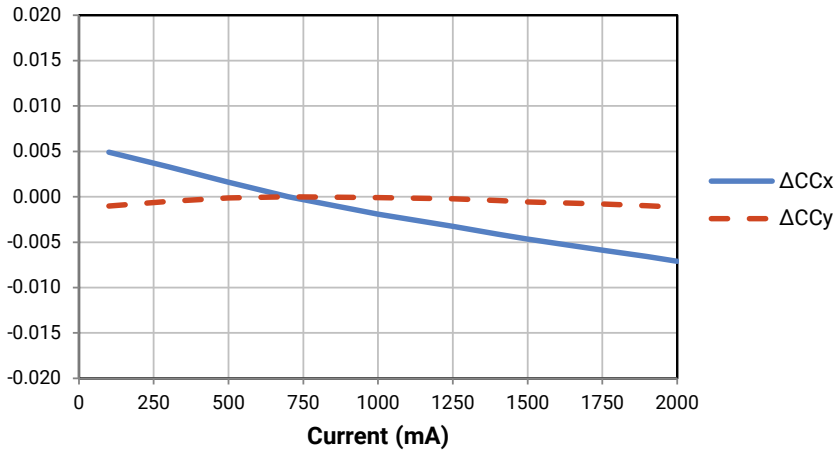

XM-L2 EZW, 12 V

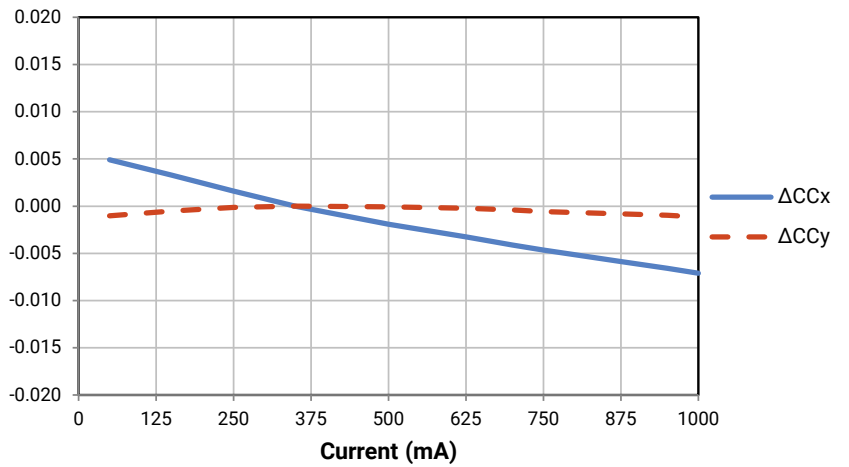

XM-L2 EZW, 6 V & 12 V

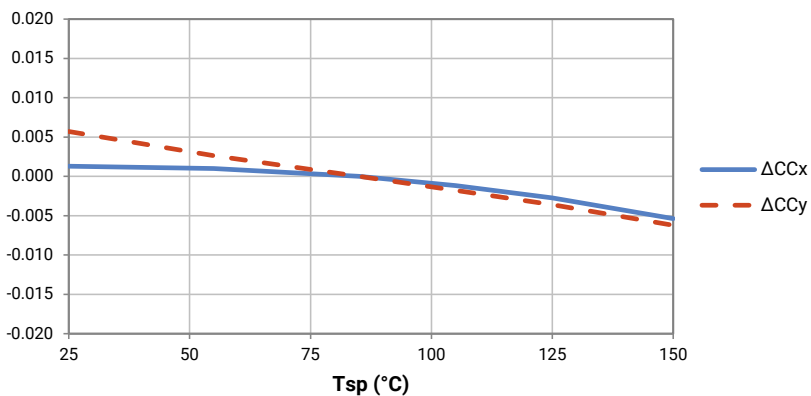

TYPICAL SPATIAL DISTRIBUTION

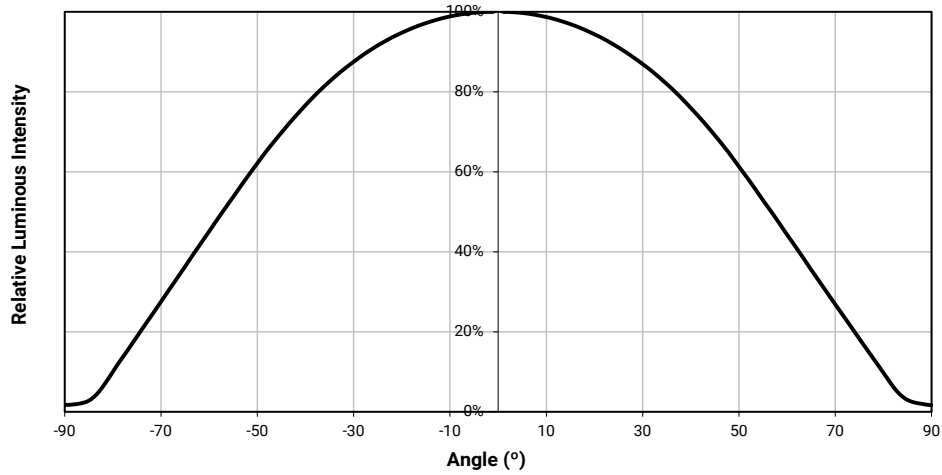

THERMAL DESIGN

The maximum forward current is determined by the thermal resistance between the LED junction and ambient. It is crucial for the end product to be designed in a manner that minimizes the thermal resistance from the solder point to ambient in order to optimize lamp life and optical characteristics.

XM-L2 EZW, 6-V

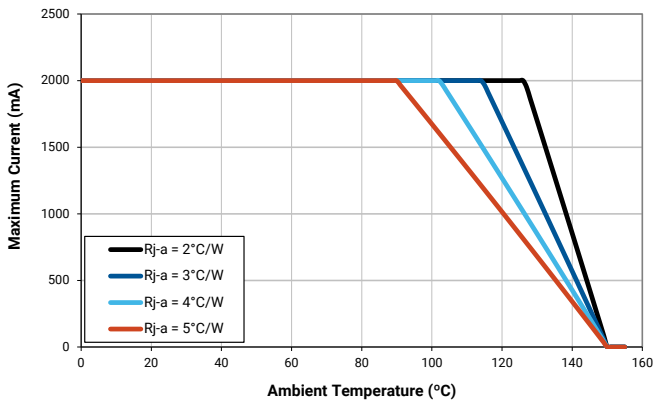

XM-L2 EZW, 12-V

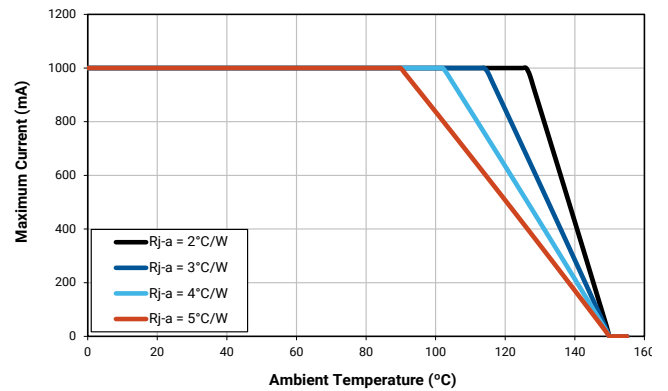

PERFORMANCE GROUPS – BRIGHTNESS ($T_j = 85\text{ }^\circ\text{C}$)

XLamp XM-L2 EasyWhite LEDs are tested for luminous flux and placed into one of the following bins.

Group Code	Minimum Luminous Flux @ 700 mA, 6 V, @ 350 mA, 12 V	Maximum Luminous Flux @ 700 mA, 6 V, @ 350 mA, 12 V
T5	260	280
T6	280	300
U2	300	320
U3	320	340
U4	340	360
U5	360	380
U6	380	400
V2	400	420
V3	420	440
V4	440	460
V5	460	480

PERFORMANCE GROUPS – CHROMATICITY ($T_j = 85\text{ }^\circ\text{C}$)

XLamp XM-L2 EasyWhite LEDs are tested for chromaticity and placed into one of the regions defined by the following bounding coordinates.

EasyWhite Color Temperatures – 4-Step			
Code	CCT	x	y
50F	5000 K	0.3407	0.3459
		0.3415	0.3586
		0.3499	0.3654
		0.3484	0.3521
40F	4000 K	0.3744	0.3685
		0.3782	0.3837
		0.3912	0.3917
		0.3863	0.3758
35F	3500 K	0.3981	0.3800
		0.4040	0.3966
		0.4186	0.4037
		0.4116	0.3865
30F	3000 K	0.4242	0.3919
		0.4322	0.4096
		0.4449	0.4141
		0.4359	0.3960
27F	2700 K	0.4475	0.3994
		0.4573	0.4178
		0.4695	0.4207
		0.4589	0.4021

EasyWhite Color Temperatures – 2-Step			
Code	CCT	x	y
50H	5000 K	0.3429	0.3507
		0.3434	0.3571
		0.3475	0.3604
		0.3469	0.3539
40H	4000 K	0.3784	0.3741
		0.3804	0.3818
		0.3867	0.3857
		0.3844	0.3778
35H	3500 K	0.4030	0.3857
		0.4061	0.3941
		0.4132	0.3976
		0.4099	0.3890
30H	3000 K	0.4291	0.3973
		0.4333	0.4062
		0.4395	0.4084
		0.4351	0.3994
27H	2700 K	0.4528	0.4046
		0.4578	0.4138
		0.4638	0.4152
		0.4586	0.4060

PERFORMANCE GROUPS - CHROMATICITY ($T_j = 85\text{ }^\circ\text{C}$) - CONTINUED

ANSI White Bins				
Code	CCT	Bin Code	x	y
0E1	6500 K	1A0	0.3048	0.3207
			0.3130	0.3290
			0.3144	0.3186
			0.3068	0.3113
		1B0	0.3028	0.3304
			0.3115	0.3391
			0.3130	0.3290
			0.3048	0.3207
		1C0	0.3115	0.3391
			0.3205	0.3481
			0.3213	0.3373
			0.3130	0.3290
		1D0	0.3130	0.3290
			0.3213	0.3373
			0.3221	0.3261
			0.3144	0.3186
ANSI White Bins				
Code	CCT	Bin Code	x	y
0E2	5700 K	2A0	0.3215	0.3350
			0.3290	0.3417
			0.3290	0.3300
			0.3222	0.3243
		2B0	0.3207	0.3462
			0.3290	0.3538
			0.3290	0.3417
			0.3215	0.3350
		2C0	0.3290	0.3538
			0.3376	0.3616
			0.3371	0.3490
			0.3290	0.3417
		2D0	0.3290	0.3417
			0.3371	0.3490
			0.3366	0.3369
			0.3290	0.3300

EASYWHITE® BINS PLOTTED ON THE 1931 CIE COLOR SPACE ($T_j = 85\text{ }^\circ\text{C}$)

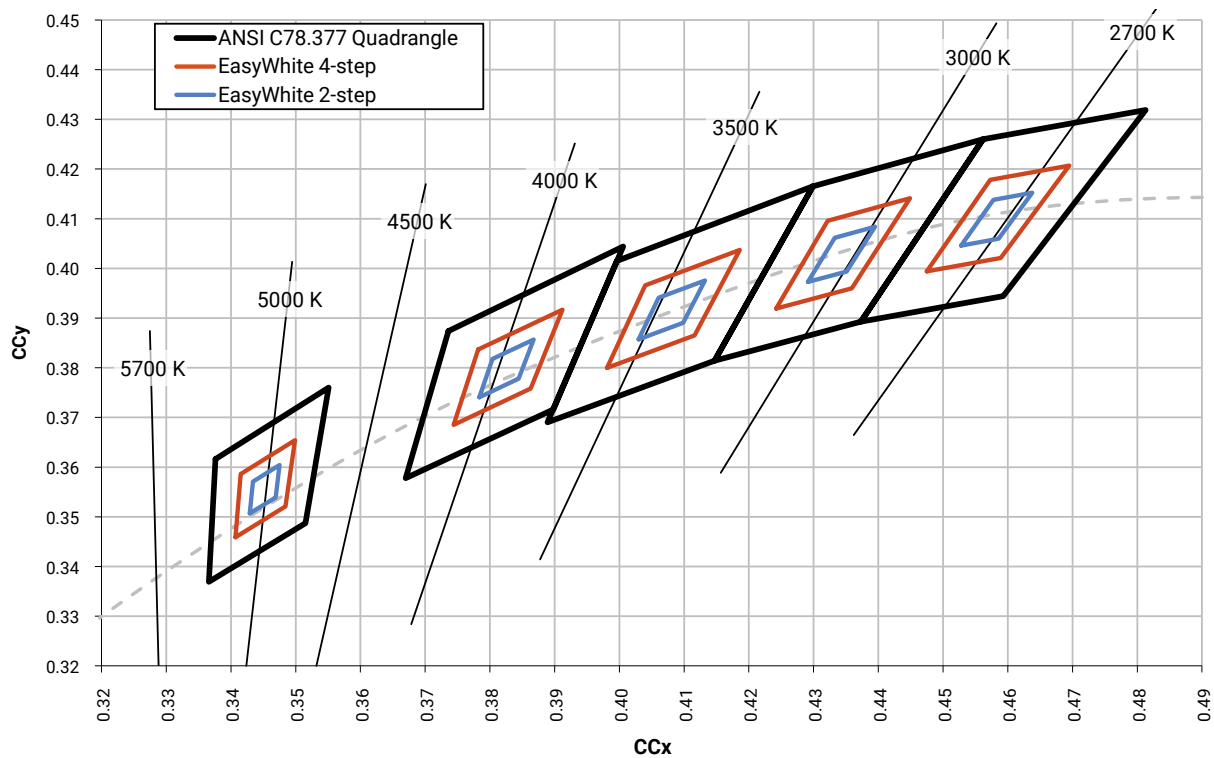

STANDARD COOL WHITE KITS PLOTTED ON ANSI STANDARD CHROMATICITY REGIONS

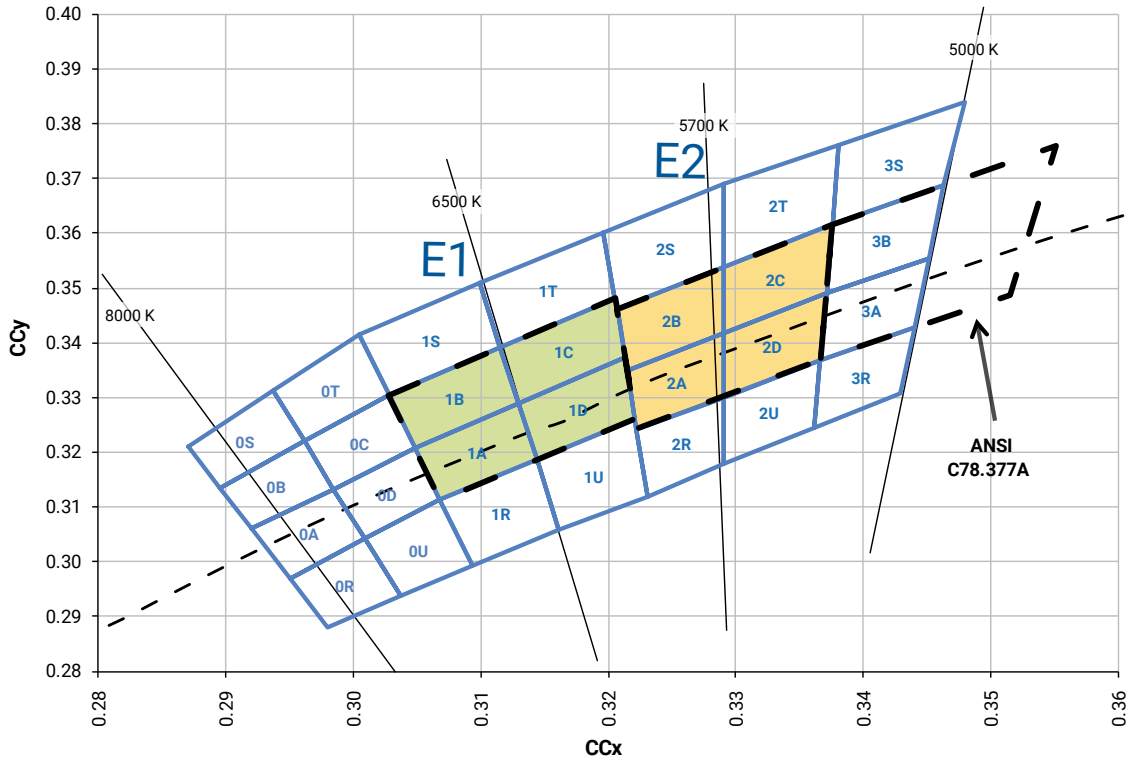

ANSI WHITE BINS PLOTTED ON THE 1931 CIE COLOR SPACE ($T_j = 85^\circ\text{C}$)

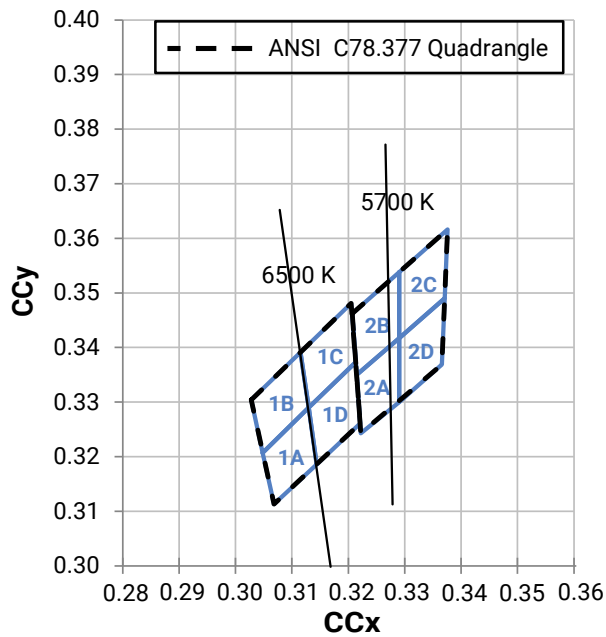

BIN AND ORDER CODE FORMATS

Bin codes and order codes are configured as follows:

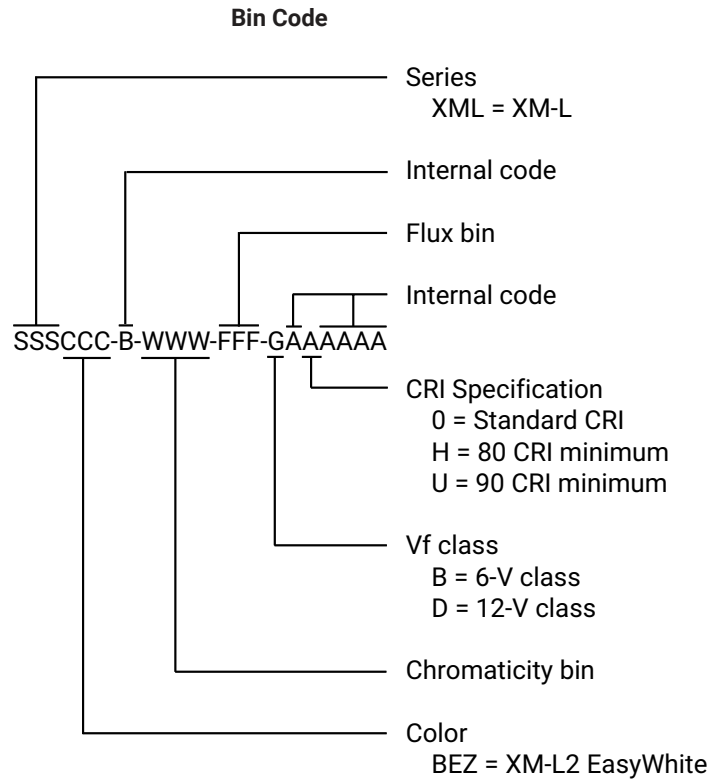
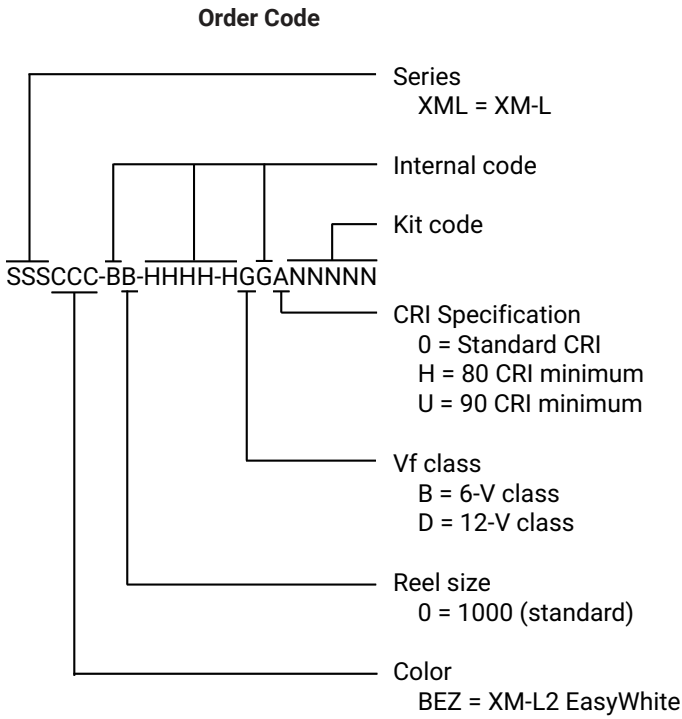

REFLOW SOLDERING CHARACTERISTICS

In testing, Cree LED has found XLamp XM-L2 EasyWhite LEDs to be compatible with JEDEC J-STD-020C, using the parameters listed below. As a general guideline, Cree LED recommends that users follow the recommended soldering profile provided by the manufacturer of the solder paste used, and therefore it is the lamp or luminaire manufacturer’s responsibility to determine applicable soldering requirements.

Note that this general guideline may not apply to all PCB designs and configurations of reflow soldering equipment.

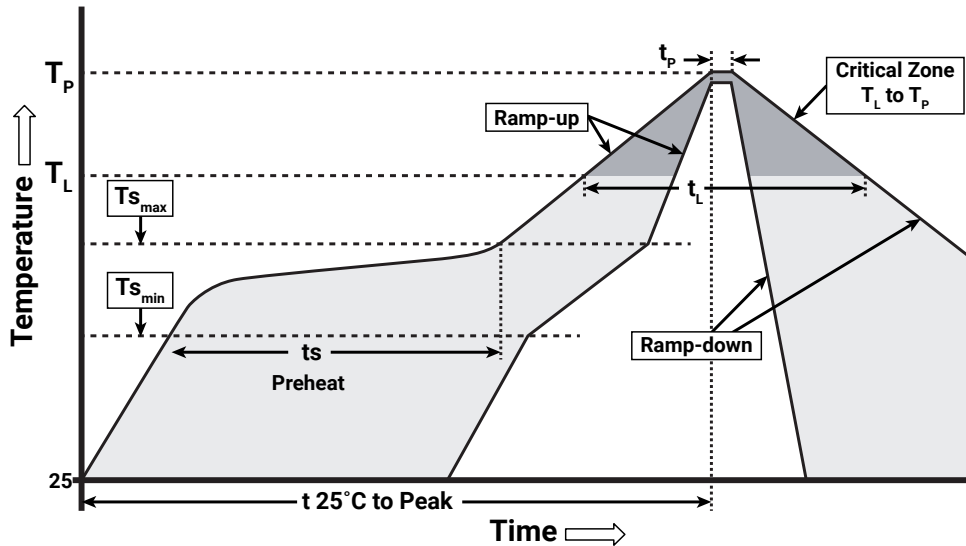

IPC/JEDEC J-STD-020C

Profile Feature	Lead-Free Solder
Average Ramp-Up Rate ($T_{s_{max}}$ to T_P)	1.2 °C/second
Preheat: Temperature Min ($T_{s_{min}}$)	120 °C
Preheat: Temperature Max ($T_{s_{max}}$)	170 °C
Preheat: Time ($T_{s_{min}}$ to $T_{s_{max}}$)	65-150 seconds
Time Maintained Above: Temperature (T_L)	217 °C
Time Maintained Above: Time (t_L)	45-90 seconds
Peak/Classification Temperature (T_P)	235 - 245 °C
Time Within 5 °C of Actual Peak Temperature (t_p)	20-40 seconds
Ramp-Down Rate	1 - 6 °C/second
Time 25 °C to Peak Temperature	4 minutes max.

Note: All temperatures refer to the topside of the package, measured on the package body surface.

NOTES

Measurements

The luminous flux, radiant power, chromaticity, forward voltage and CRI measurements in this document are binning specifications only and solely represent product measurements as of the date of shipment. These measurements will change over time based on a number of factors that are not within Cree LED's control and are not intended or provided as operational specifications for the products. Calculated values are provided for informational purposes only and are not intended or provided as specifications.

Pre-Release Qualification Testing

Please read the [LED Reliability Overview](#) for details of the qualification process Cree LED applies to ensure long-term reliability for XLamp LEDs and details of Cree LED's pre-release qualification testing for XLamp LEDs.

Lumen Maintenance

Cree LED now uses standardized IES LM-80-08 and TM-21-11 methods for collecting long-term data and extrapolating LED lumen maintenance. For information on the specific LM-80 data sets available for this LED, refer to the public [LM-80 results document](#).

Please read the [Long-Term Lumen Maintenance application note](#) for more details on Cree LED's lumen maintenance testing and forecasting. Please read the [Thermal Management application note](#) for details on how thermal design, ambient temperature, and drive current affect the LED junction temperature.

Moisture Sensitivity

Cree LED recommends keeping XLamp LEDs in the provided, resealable moisture-barrier packaging (MBP) until immediately prior to soldering. Unopened MBPs that contain XLamp LEDs do not need special storage for moisture sensitivity.

Once the MBP is opened, XLamp XM-L2 EasyWhite LEDs may be stored as MSL 1 per JEDEC J-STD-033, meaning they have unlimited floor life in conditions of ≤ 30 °C/85% relative humidity (RH). Regardless of the storage condition, Cree LED recommends sealing any unsoldered LEDs in the original MBP.

RoHS Compliance

The levels of RoHS restricted materials in this product are below the maximum concentration values (also referred to as the threshold limits) permitted for such substances, or are used in an exempted application, in accordance with EU Directive 2011/65/EC (RoHS2), as implemented January 2, 2013. RoHS Declarations for this product can be obtained from your Cree LED representative or from the [Product Ecology](#) section of the Cree LED website.

REACH Compliance

REACH substances of very high concern (SVHCs) information is available for this product. Since the European Chemical Agency (ECHA) has published notice of their intent to frequently revise the SVHC listing for the foreseeable future, please contact a Cree LED representative to insure you get the most up-to-date REACH Declaration. REACH banned substance information (REACH Article 67) is also available upon request.

NOTES - CONTINUED

UL® Recognized Component

This product meets the requirements to be considered a UL Recognized Component with Level 4 enclosure consideration. The LED package or a portion thereof has been investigated as a fire and electrical enclosure per ANSI/UL 8750.

Vision Advisory

WARNING. Do not look at an exposed lamp in operation. Eye injury can result. For more information about LEDs and eye safety, please refer to the [LED Eye Safety application note](#).

MECHANICAL DIMENSIONS

Thermal vias, if present, are not shown on these drawings.

All measurements are ± 0.13 mm unless otherwise indicated

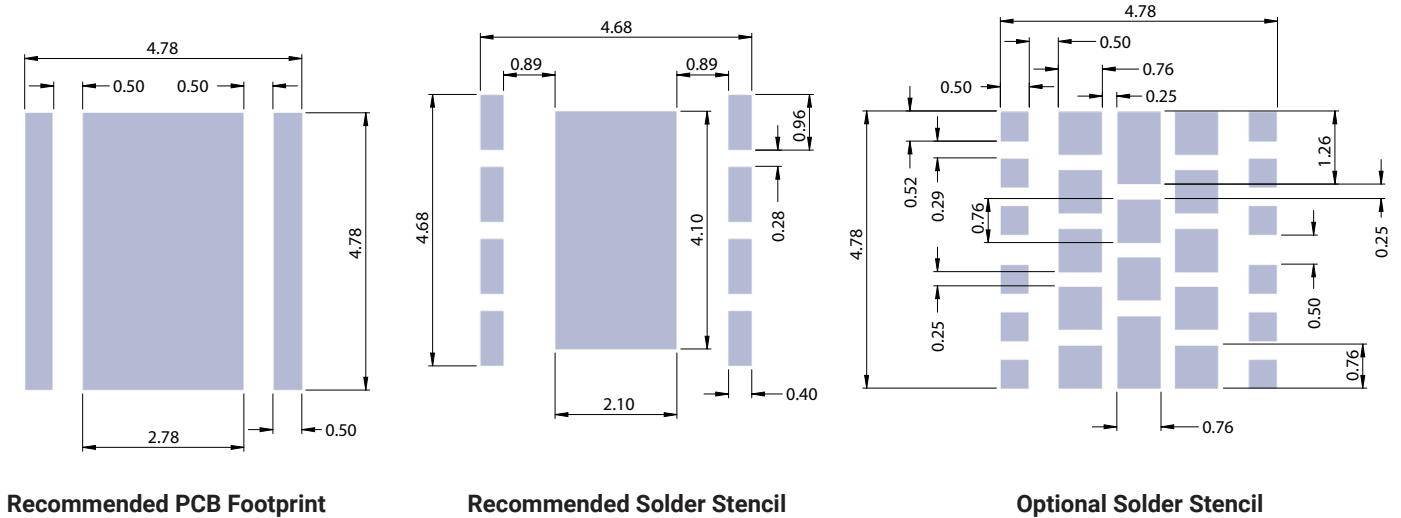
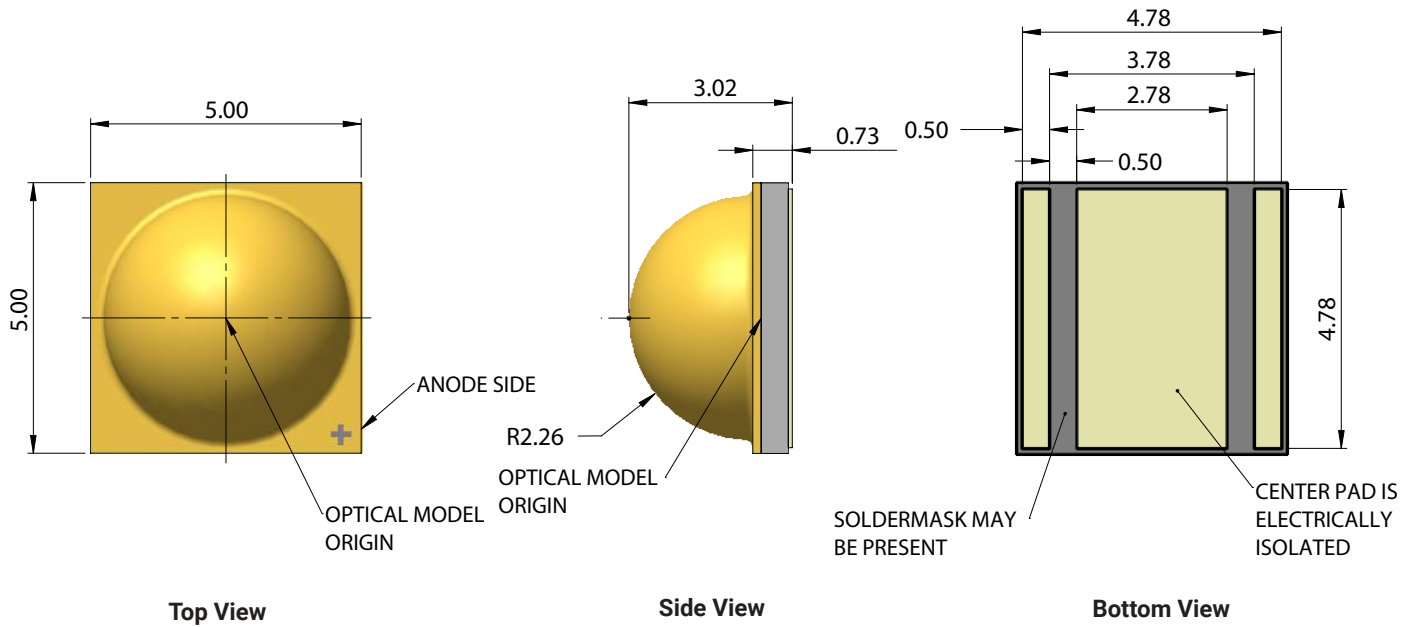

TAPE AND REEL

All Cree LED carrier tapes conform to EIA-481D, Automated Component Handling Systems Standard.

All dimensions in mm.

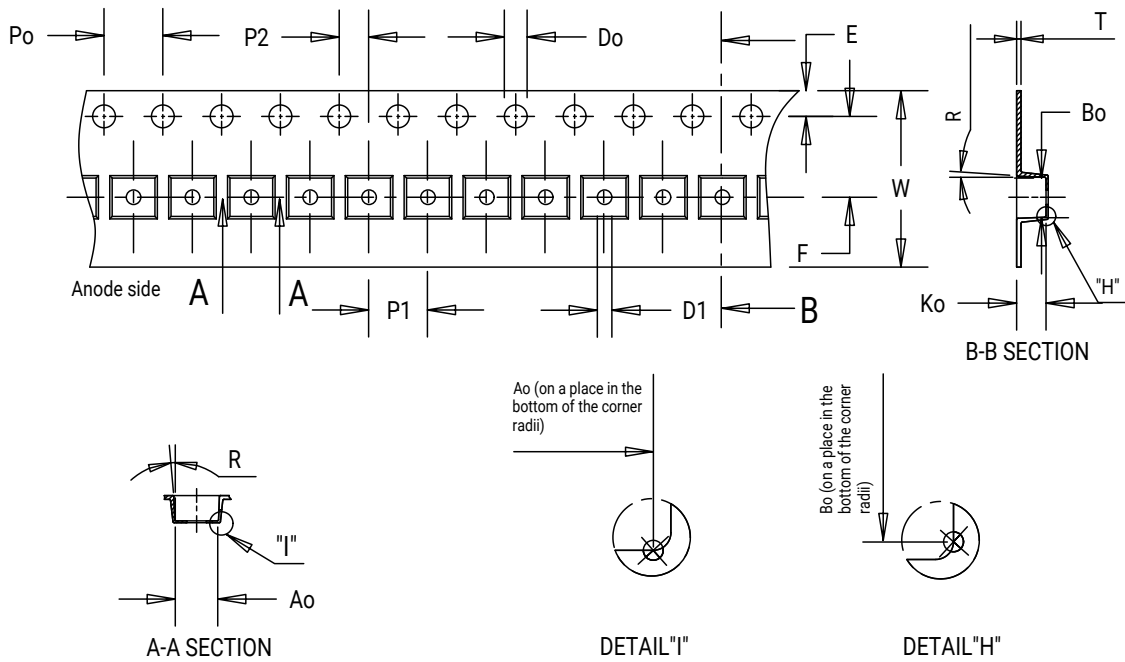

Item	Ao	Bo	Ko	Po	P1	P2	T	E	F	Do	D1	W	R
Dim.	5.40	5.40	3.35	4.00	8.00	2.00	0.36	1.75	5.50	1.50	1.50	12.00	3°

TAPE AND REEL - CONTINUED

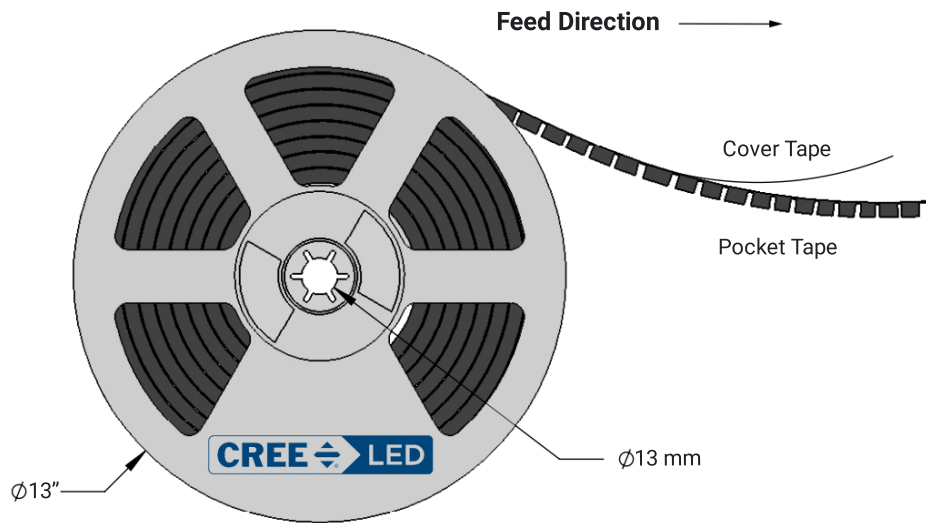
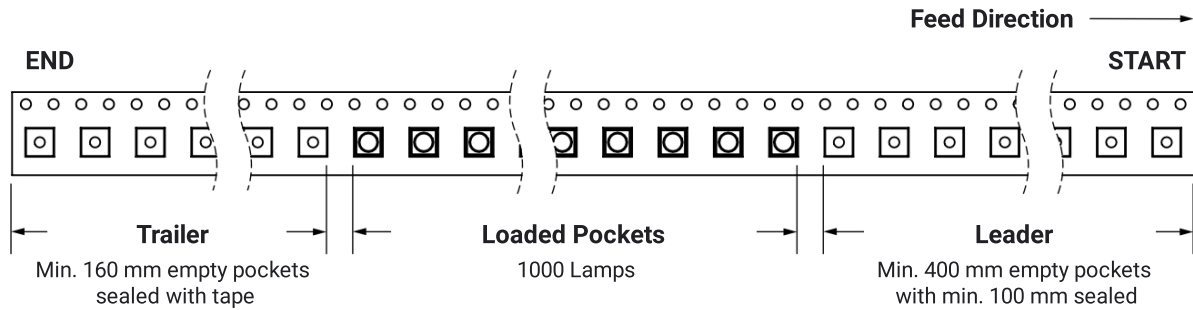

PACKAGING

Unpackaged Reel

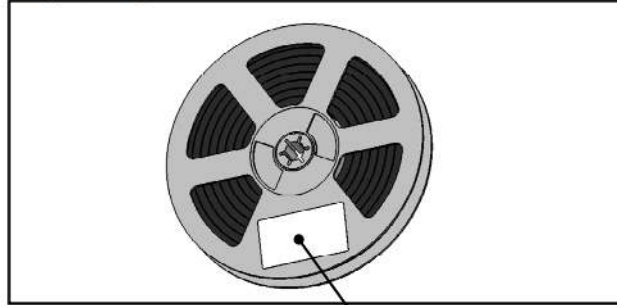

Label with Cree LED Bin Code, Quantity, Reel ID

Packaged Reel

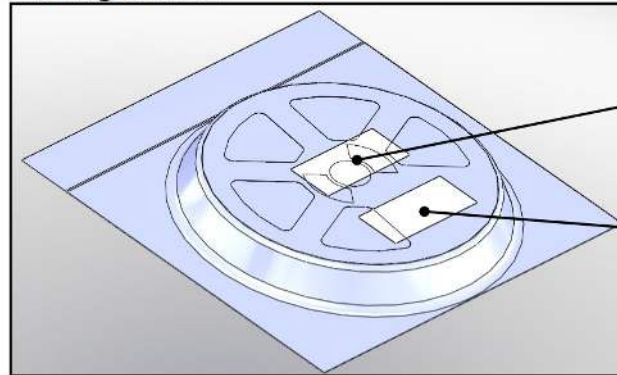

Label with Cree LED Order Code, Quantity, Reel ID, PO#

Label with Cree LED Bin Code, Quantity, Reel ID

Boxed Reel

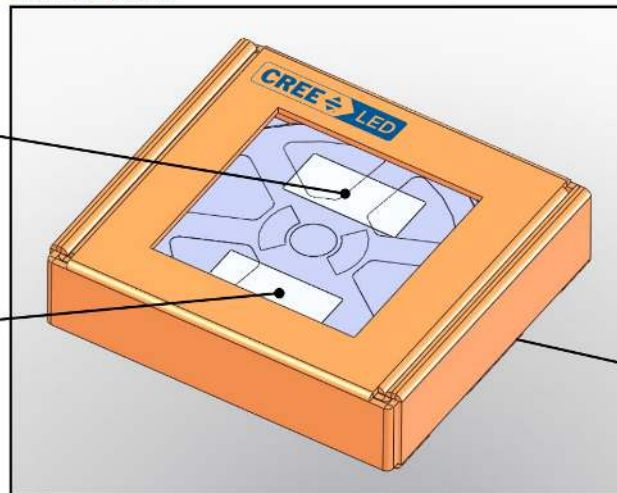

Label with Cree LED Order Code, Quantity, Reel ID, PO#

Label with Cree LED Bin Code, Quantity, Reel ID

Patent Label (on bottom of box)