

SiC SBD P3D06010E2

650V SiC Schottky Diode



TO-252-2

Cathode	1
Anode	2



Features

- Qualified to AEC-Q101
- Ultra-Fast Switching
- Zero Reverse Recovery Current
- High-Frequency Operation
- Positive Temperature Coefficient on V_F
- High Surge Current
- 100% UIS tested

Standards Benefits

- Improve System Efficiency
- Reduction of Heat Sink Requirement
- Essentially No Switching Losses
- Parallel Devices Without Thermal Runaway



Application

- Consumer SMPS
- Boost Diodes in PFC or DC/DC Stages
- AC/DC Converters



Order Information

Part Number	Package	Marking
P3D06010E2	TO-252-2	P3D06010E2



Contents

Features.....	1
Standards Benefits	1
Application.....	1
Order Information	1
Contents.....	2
1. Maximum Ratings.....	3
2. Thermal Characteristics.....	3
3. Electrical Characteristics	4
4. Typical Performance	5
5. Package Outlines.....	6

PNJ Preliminary

1. Maximum Ratings

At $T_J = 25^\circ\text{C}$, unless specified otherwise

Parameter	Symbol	Value	Unit	Test condition
Repetitive Peak Reverse Voltage	V_{RRM}	650	V	$T_C = 25^\circ\text{C}$
Surge Peak Reverse Voltage	V_{RSM}	650	V	$T_C = 25^\circ\text{C}$
DC Blocking Voltage	V_R	650	V	$T_C = 25^\circ\text{C}$
Forward Current	I_F	28	A	$T_C = 25^\circ\text{C}$
		15		$T_C = 125^\circ\text{C}$
		10		$T_C = 150^\circ\text{C}$
Repetitive Peak Forward Surge Current	I_{FRM}	52	A	$T_C = 25^\circ\text{C}, t_p = 10\text{ms}$
		27		$T_C = 125^\circ\text{C}, t_p = 10\text{ms}$
Non-Repetitive Forward Surge Current	I_{FSM}	75	A	$T_C = 25^\circ\text{C}, t_p = 10\text{ms}$
		62		$T_C = 125^\circ\text{C}, t_p = 10\text{ms}$
Power Dissipation	P_{tot}	99	W	$T_C = 25^\circ\text{C}$
Operating Junction and Storage Temperature	T_J, T_{STG}	-55 to +175	$^\circ\text{C}$	
TO-220 Mounting Torque M3 Screw	T_{orq}	1	Nm lbf-in	
		8.8		

2. Thermal Characteristics

Parameter	Symbol	Values	Unit
Thermal Resistance from Junction to Case	$R_{\theta JC}$	1.51	$^\circ\text{C}/\text{W}$

3. Electrical Characteristics

At $T_J = 25^\circ\text{C}$, unless specified otherwise

Parameter	Symbol	Values			Unit	Test condition
		Min.	Typ.	Max.		
Forward Voltage	V_F	/	1.39	1.6	V	$I_F = 10\text{A}, T_J = 25^\circ\text{C}$
			1.65	/		$I_F = 10\text{A}, T_J = 175^\circ\text{C}$
Reverse Current	I_R	/	12.8	44	μA	$V_R = 650\text{V}, T_J = 25^\circ\text{C}$
			424	/		$V_R = 650\text{V}, T_J = 175^\circ\text{C}$
Total Capacitance	C	/	452	/	pF	$V_R = 0\text{V}, T_J = 25^\circ\text{C}$ $f = 1\text{MHz}$
			48			$V_R = 200\text{V}, T_J = 25^\circ\text{C}$ $f = 1\text{MHz}$
			36			$V_R = 400\text{V}, T_J = 25^\circ\text{C}$ $f = 1\text{MHz}$
Total Capacitive Charge	Q_C	/	24.8	/	nC	$V_R = 400\text{V}, I_F = 10\text{A}$ $T_J = 25^\circ\text{C}$
Capacitance Stored Energy	E_C	/	2.92	/	μJ	$V_R = 400\text{V}$

4. Typical Performance

At $T_J = 25^\circ\text{C}$, unless specified otherwise

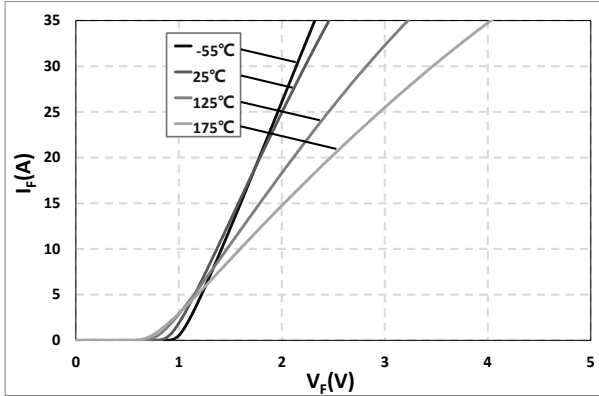

Fig. 1 Typical Forward Characteristics
 $I_F = f(V_F)$; $T_J = -55^\circ\text{C}, 25^\circ\text{C}, 125^\circ\text{C}, 175^\circ\text{C}$

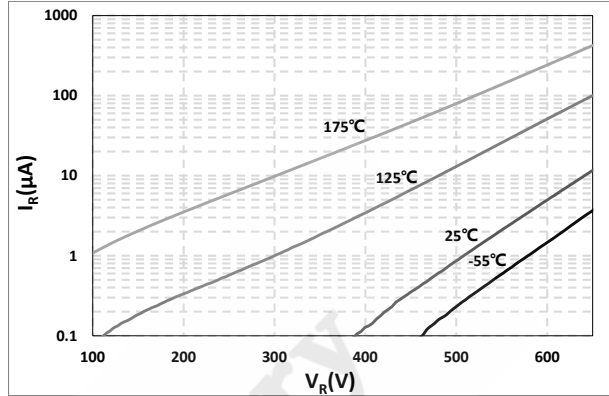

Fig. 2 Reverse Characteristics
 $I_R = f(V_R)$; $T_J = -55^\circ\text{C}, 25^\circ\text{C}, 125^\circ\text{C}, 175^\circ\text{C}$

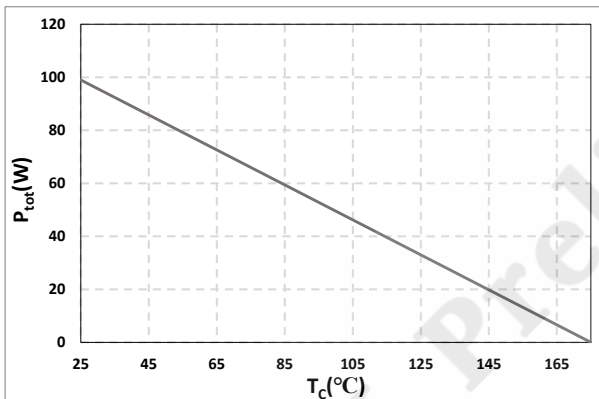

Fig. 3 Typical Power Derating
 $P_{tot} = f(T_c)$

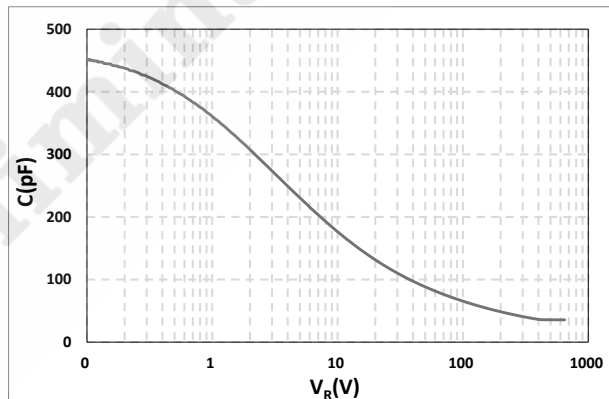

Fig. 4 Typical Total Capacitance
 $C = f(V_R)$

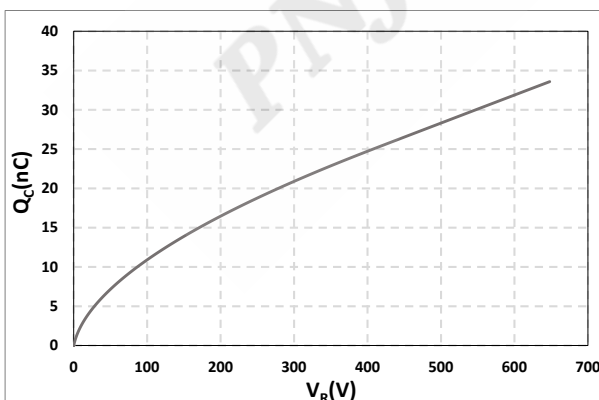

Fig. 5 Typical Total Capacitive Charge
 $Q_C = f(V_R)$

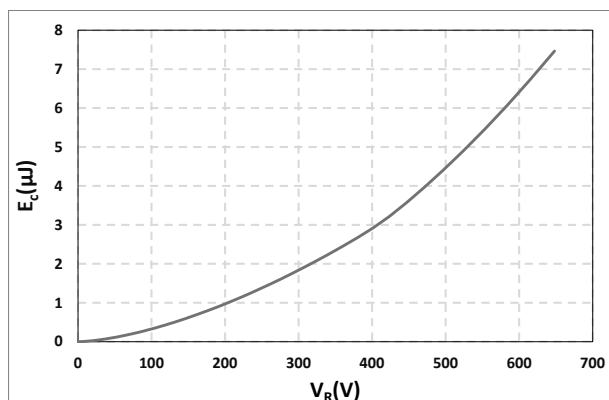
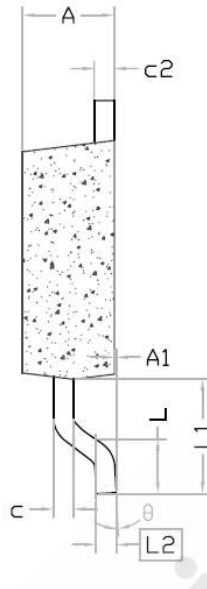
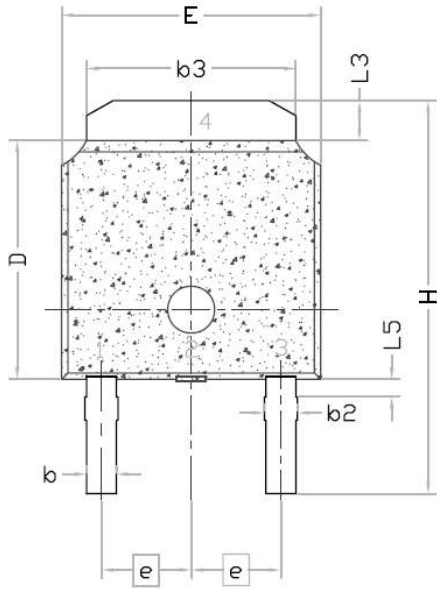

Fig. 6 Capacitance Stored Energy
 $E_C = f(V_R)$

5. Package Outlines



SYMBOL	DIMENSIONAL REQMTS		
	MIN	NOM	MAX
E	6.40	6.60	6.731
L	1.40	1.52	1.77
L1	2.743 REF		
L2	0.508 BSC		
L3	0.89	--	1.27
L5	--	--	--
D	6.00	6.10	6.223
H	9.40	10.00	10.40
b	0.64	0.76	0.88
b2	0.77	0.84	1.14
b3	5.21	5.34	5.46
e	2.286 BSC		
A	2.20	2.30	2.38
A1	0	--	0.127
c	0.46	0.50	0.60
c2	0.46	0.50	0.58
D1	5.21	--	--
E1	4.40	--	--
F	--	--	0.45
theta	0°	--	10°

Drawing and dimensions

PNJ Preliminary