

iFLEX[®] Lasers

*High-Performance Laser Systems for
Scientific, Analytical and Metrology Applications*

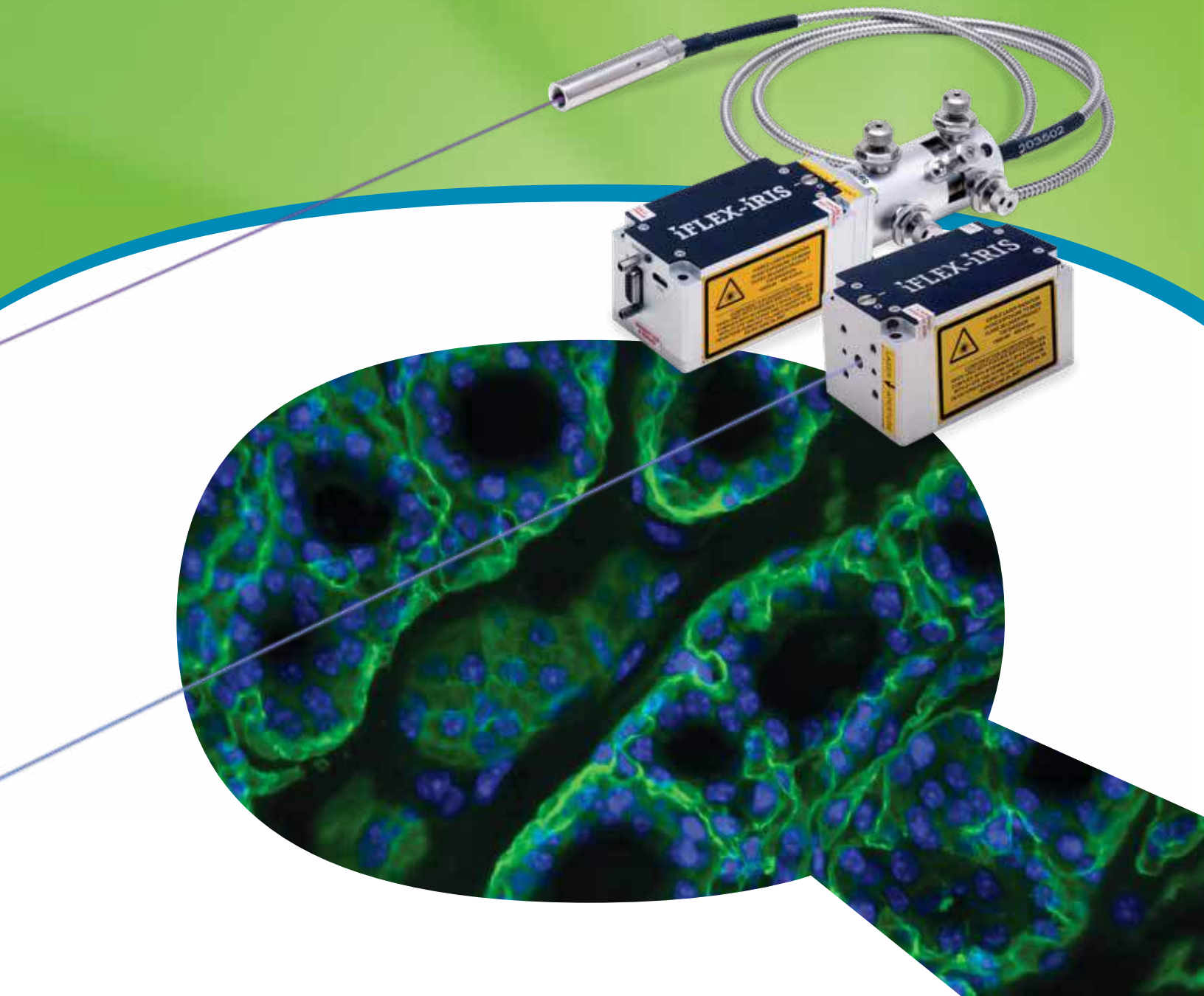

Company Profile

Qioptiq, an Excelitas Technologies Company, designs and manufactures photonic products and solutions that serve a wide range of markets and applications in the areas of medical and life sciences, industrial manufacturing, semiconductor, defense and aerospace, and research and development.

Qioptiq benefits from having integrated the knowledge and experience of Avimo, Gsänger, LINOS, Optem, Pilkington, Point Source, Rodenstock, Spindler & Hoyer and others. In October 2013,

Qioptiq was acquired by Excelitas Technologies Corp., a global technology leader focused on delivering innovative, customized solutions to meet the lighting, detection and other high-performance technology needs of OEM customers. The combined companies have approximately 5,500 employees in North America, Europe and Asia, serving customers across the world.

Visit www.qioptiq.com and www.excelitas.com for more information.

1877



Rodenstock
founded

1898



Spindler & Hoyer
founded

1966

Pilkington PE
Ltd. founded,
which later
becomes
THALES Optics

1969



Gsänger
Optoelektronik
founded

1984



Optem
International
founded

1991



Point Source
founded

1996



LINOS founded
through the merger
of Spindler & Hoyer,
Steeg & Reuter
Präzisionsoptik,
Franke Optik and
Gsänger Optoelektronik

Content



**Medical &
Life Sciences**



**Industrial
Manufacturing**



**Defense &
Aerospace**



**Research &
Development**

Company Profile 02 - 03

iFLEX-iRIS

Introduction & Product Line 04

iFLEX-iRIS CLM-Concepts and Features 06

Wavelengths and Specifications 07

iFLEX-Gemini

Introduction 08

iFLEX-Gemini CLM Features 08

Wavelengths and Specifications 09

iFLEX-Viper

Introduction 10

Wavelengths and Specifications 11

Fibers and Optomechanics

Introduction 12-13

OEM Expertise & Capabilities 14

Total Wavelengths Served 15

2000



Rodenstock
Präzisionsoptik
acquired
by LINOS

2001



AVIMO Group
acquired
by THALES

2005

Qioptiq
founded as
THALES sells
High Tech
Optics Group

2006 / 2007



Qioptiq acquires
LINOS and Point Source
as "members of the
Qioptiq group"

2010



The new Qioptiq
consolidates all
group members
under one brand

2013



Qioptiq is acquired by
Excelitas Technologies

Precision Performance with iFLEX® Lasers

Qioptiq designs and manufactures high-performance solid-state laser systems and fiber optics for a range of scientific and industrial applications.

The iFLEX® family of laser technology includes the high performance iFLEX-iRIS™ laser series and the ultra-stable, multi-wavelength laser engine series of iFLEX-Gemini™ and iFLEX-Viper®.

4 Combine iFLEX lasers with the kineFLEX® single-mode fiber optics manufactured by Qioptiq, to create the world's most stable fiber coupled lasers.

With over 25 years of experience delivering market-leading technology, Qioptiq continues to support customers with demanding applications in semicon, biotech, analytical and industry, through new innovations in iFLEX laser technology.

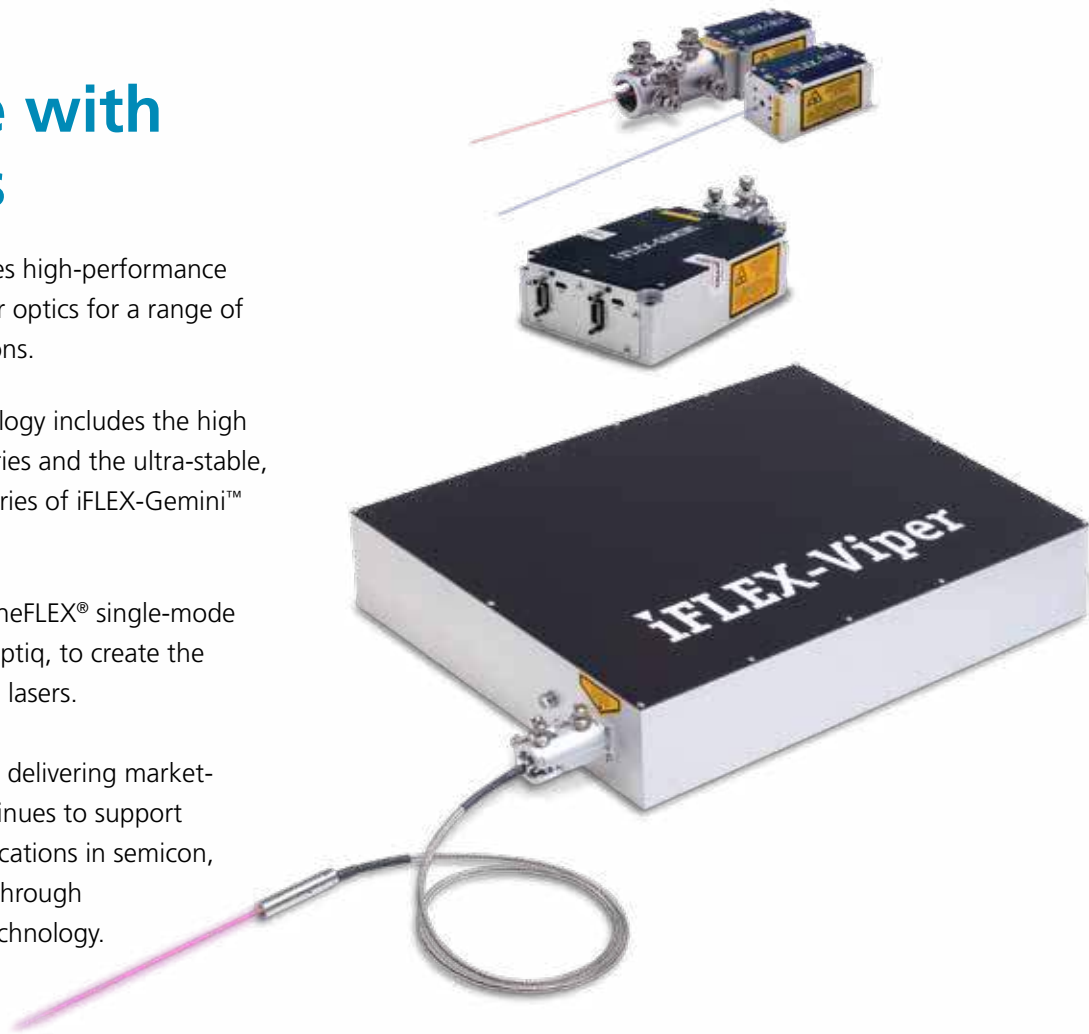

Applications & Features

Features:

- Exceptional power stability
- Unmatched beam pointing stability
- Ultra-low noise performance
- Excellent beam quality
- Fully integrated electronics
- Compact size for easy integration
- End user and OEM systems
- Integrated beam shaping
- "Plug & Play" fiber delivery
- "Set & Forget" alignment

Applications:

- Microscopy
- Flow Cytometry
- DNA Sequencing
- Metrology
- Inspection
- Ophthalmology
- Molecular Imaging
- Dynamic Light Scattering
- Spectroscopy
- Environmental Monitoring

“Integrate highly reliable laser sources into your OEM systems for the ultimate in precision and illumination performance.”

iFLEX-iRIS

Compact, Single-Wavelength Laser Series

The iFLEX-iRIS™ laser series is a range of solid-state, high-performance lasers with low amplitude noise. For ease of use and integration, all wavelengths are offered in the same compact package with the same control inputs. All TEC and smart control electronics are integrated in the laser. They make ideal building blocks for OEM instrument designers and researchers alike.

Closed-Loop Modulation (CLM)

6 The innovative Closed-Loop Modulation (CLM) feature allows the lasers to operate with automatic power control feedback in all modes of operation; CW, plus digital, analogue and dual mode modulation. These lasers maintain excellent power stability in all modes of operation and throughout the laser lifetime. Unlike traditional open loop laser modulation, there is no need for laser calibration reset when using iFLEX-iRIS lasers with the CLM feature.

Lasers with CLM are ultra-low noise in terms of RMS, RIN and periodic noise. They also offer precision adjustment at all output power levels. This is very useful for imaging applications where a stable, ultra-low noise source will improve the signal-to-noise ratio and image resolution.



Fiber Delivery

The iFLEX-iRIS lasers can be supplied with a single-mode fiber output. Alternatively, and as requirements change, a single-mode fiber can be added later on by the user to the -X0 laser option, which has the beam exit location centralized in the front face. Thus, the iFLEX-iRIS provides true "Plug and Play" versatility as a free space or fiber coupled laser.

iFLEX-iRIS lasers are designed to fiber couple into the kineFLEX® fiber delivery system. As a result these lasers are ultra-stable when used as free space or fiber coupled. There are standard options for different fiber lengths and either collimated or connector outputs.

A second, free space iFLEX-iRIS laser -X2 option is offered which has the beam exit location offset in the front face, for ease of retrofit in some instruments.

CDRH Compliance for End Users

iFLEX-iRIS lasers are CDRH compliant when used with an iFLEX-iRIS CDRH interlock power supply.

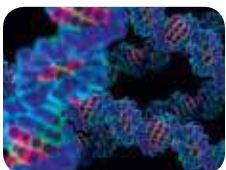

Example: Dual mode modulation

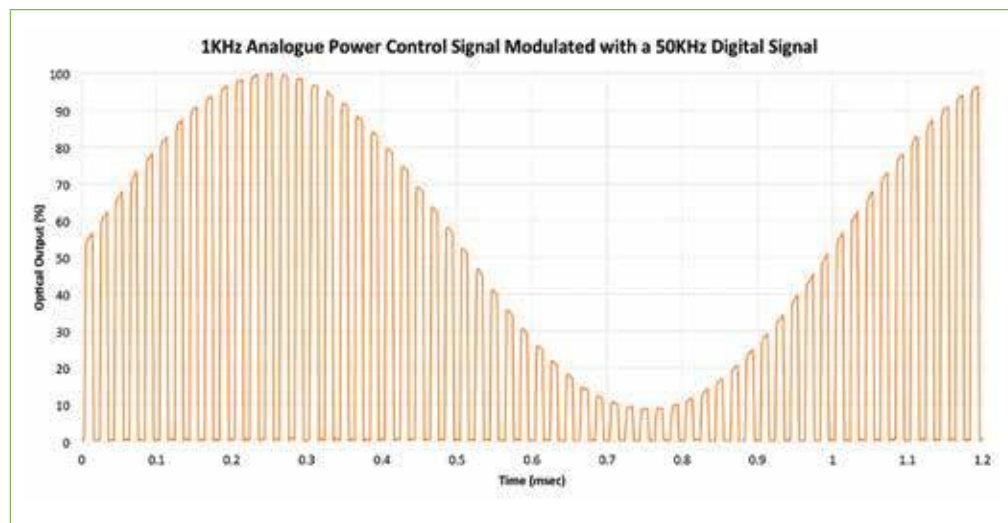

iFLEX-iRIS lasers



Wavelengths (nm) and Power (mW)																				
375	405	415	445	458	473	488	505	515	520	532	561	594	633	640	647	660	670	730	780	852
20	50	100	20	20	75	20	50	20	30	20	20	20	30	20	50	80	10	20	70	35
40	100		50	70		40		50		40	40		70	40						
50	200		75			100		60						100						
	220					140								150						



iFLEX-iRIS fiber coupled lasers

Wavelengths (nm) and Power after fiber (mW)																				
375	405	415	445	458	473	488	505	515	520	532	561	594	633	640	647	660	670	730	780	852
25	30	65	30	45	50	25	30	40	20	25	25	12	20	25	30	50	6	10	45	20
30	60		50			65							45	65						
	100					90								95						
	140																			

iFLEX-iRIS laser specification overview

Wavelength (nm)**	CLM, 375-520 nm & 633-852 nm	532	561	594
Spatial mode, TEM ₀₀	M ² < 1.2 direct beam M ² < 1.1 after fiber output			
Beam Ø at 1/e ²	0.7 ± 0.2mm (0.8 ± 0.2mm for λ=660, 670, 730 and 852nm) direct beam 0.7 ± 0.1mm after fiber output			
Pointing stability	< 5 µrad/°C direct beam 1 µrad/°C after fiber output			
Polarization ratio	≥ 200:1, Vertical ± 2°			
Power supply	12V DC, 1A			
Base plate temp.	40 °C maximum			
Heat dissipation	12 W maximum, < 5W typical			
Operation modes	CW / Modulated: Analogue, Digital, Dual Input / Software	CW		
Power stability, 8 hrs	< 0.5 %	< 2 %		
RMS noise (20Hz - 20MHz)	< 0.1 * %	< 0.3 * %, <0.1% 561 nm		
Peak-peak noise (20Hz to 1MHz)	< 0.5* %	< 3* %		
Max periodic noise spike (1KHz -1MHz)	< 0.05* %	<0.3*%, <0.1% 561 nm		
CW, power adjustment	0%, 0.1 - 100%	Off, 50-100%, and 561 nm Off, 15-100%		
Digital modulation	Bandwidth DC to 5 MHz Extinction ratio 1,000,000:1 Rise / fall time < 100 nsec	OEM options		
Analogue modulation	Bandwidth DC to 5 MHz Extinction ratio 1,000,000:1 Rise / fall time < 100 nsec Power adjustment Off and 0.1-100%	OEM options		
Dual mode modulation	Two input ports for modulation; same specifications as above. Simultaneous input signals for a) Digital fast On/Off, and b) Analogue power adjustment via external 0-5V input or internal software setting.	OEM options		
Communication	micro-USB, RS232	OEM options		

*Typical performance and wavelength dependant
**Center wavelength tolerance typically ±5 nm.

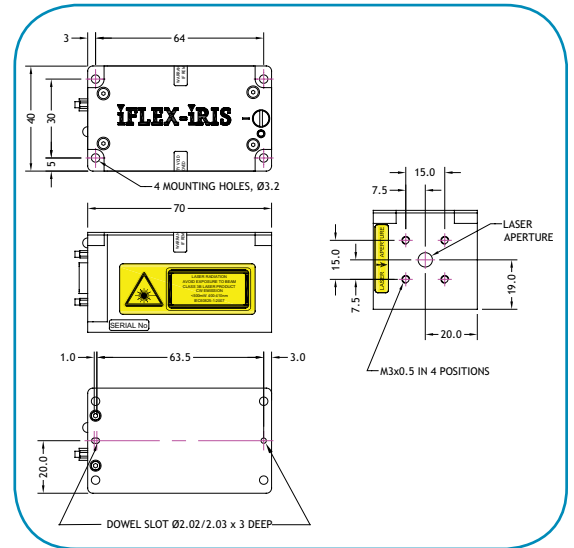

iFLEX-iRIS Laser

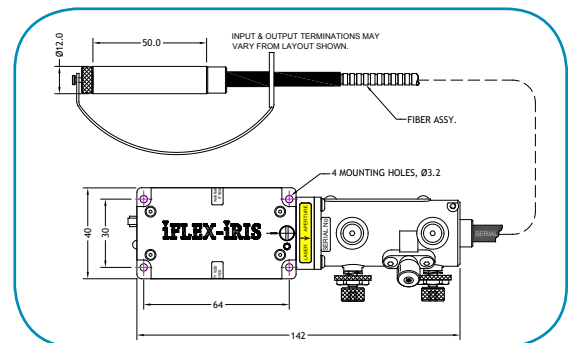

iFLEX-iRIS Fiber Coupled Laser

iFLEX-Gemini Dual-Wavelength Laser Engine Series

The iFLEX-Gemini™ is a series of small, solid-state 2-line laser engines providing a combined, co-axial output beam. It is a turnkey system for OEM instrumentation and researchers. Standard wavelength pairs are listed; custom options available on demand. Applications include: confocal microscopy, flow cytometry, particle sizing, materials testing, optogenetics, metrology, replacement for gas lasers, forensics and medical imaging instrumentation.

- 8 **Precision Control**
Each laser is controlled independently and directly, instead of combining beams through an AOTF. This provides a faster response time as well as instant switching between lines, plus the option for simultaneous emission.



Fiber Delivery

The iFLEX-Gemini lasers can be supplied with a single-mode fiber output. The user can add or remove the kineFLEX® fiber themselves which provides great flexibility for researchers.

CDRH Compliance for End Users

The iFLEX-Gemini laser engine is CDRH compliant when used with its CDRH interlock power supply option.

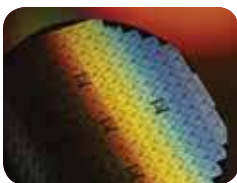
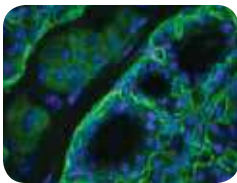

Features & Benefits

Features:

- Output: Combined, coaxial
- Fully independent laser control
- True Off for each wavelength
- Exceptional power stability
- Ultra-low noise performance
- Class-leading beam pointing stability
- OEM and End User options

Benefits:

- No laser alignment required
- Easy to use, portable, turnkey system
- Longer useful lifetime compared to traditional gas lasers
- x10 smaller than equivalent Argon laser
- Direct modulation of each wavelength
- Reliable and repeatable measurements

iFLEX-Gemini laser specification overview

iFLEX-Gemini						
λ_1/λ_2	445	488	515	561	640	647
405	50/50	50/50	-	-	50/50	
445	-	-	50/50	-	-	-
488	-	-	50/50	50/30	50/50	

Direct laser power (mW). Standard λ pairs.

Fiber coupled iFLEX-Gemini						
(nm)	445	488	515	561	640	647
405	30/30	30/30	-	-	30/30	
445	-	-	30/30	-	-	-
488	-	-	30/30	30/20	30/30	

Fiber delivered power (mW). Standard λ pairs shown.

Wavelength (nm)	405 ± 5	445 ± 5	488 ± 2	515 ± 2	561 ± 2	640 ± 5 or 647 ± 5
Noise (rms) 20Hz-2MHz	< 0.1 %		< 0.3 %			< 0.1 %
Power stability, 8 hrs	< 2 %					
Spatial mode, TEM ₀₀	M ² < 1.2 typical					
Laser output beam	0.7 mm ± 0.2 mm collimated diameter, collinear					
Standard fiber options	Type: SM PM fiber Length: 1m, 2m or 3m Output: Collimated Ø0.7mm beam or Connector FCP / APC / FCP8					
Pointing stability	< 1 µrad/°C after fiber output < 5 µrad/°C with direct beam (no fiber)					
Polarization ratio	≥ 100:1					
Max. base plate temp.	40 °C					
Max. heat dissipation	24 W, < 5W typical					
CW, power adjustment	0%, 0.1 - 100%				0%, 15– 100%	0%, 0.1 - 100%
Digital modulation	TTL signal DC to 500 kHz < 1 µsec				OEM options	TTL signal DC to 500 kHz < 1 µsec
Bandwidth Rise / fall time						
Dimensions	130 (L) x 90 (W) x 38 (H) mm					

9

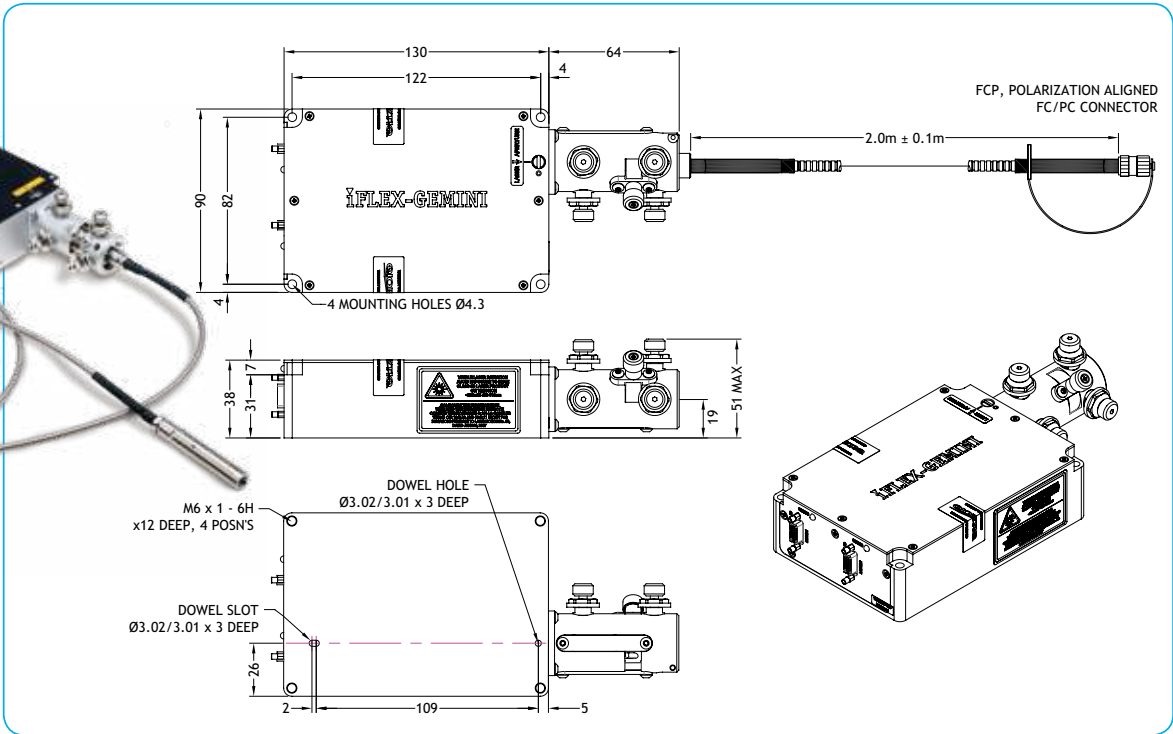

iFLEX-Viper Multi-Wavelength Laser Engine Series

The iFLEX-Viper® is a high-performance, solid-state, multi-wavelength laser engine providing up to 5 lasers in a single system with combined, co-axial output. Robust design eliminates the need for user alignment of the internal laser sources. It is portable and easy to use.

Precision Control

The power adjustment and modulation pattern for each laser is independently controlled; instead of combining beams through an AOTF and allowing the lasers to always emit. Fully independent laser control enables instantaneous switching between wavelengths and simultaneous emission of any wavelength combination. Lasers will only emit when requested, so lifetime may be extended.

Automatic closed-loop control ensures excellent long-term power stability.

Permanent Laser Alignment

Robust, novel, opto-mechanical design in the iFLEX-Viper eliminates the need for user alignment of the internal laser sources. It is a true turnkey system requiring only a drive signal per line to initiate laser emission. The ultra-stable design delivers reliable and repeatable measurements in all applications.



Compact OEM 4-line iFLEX-Viper next to iFLEX-iRIS laser



It is a true turnkey system for researchers, easily connected by fiber to microscopes and other instruments. Compact OEM versions also available.

Fiber Delivery

The iFLEX-Viper is designed to fiber couple into the kineFLEX single-mode, polarization-maintaining fiber delivery system. After the fiber output, the different wavelength beams remain co-axial, polarized and combined as they propagate through any other optics and onto the sample where they overlap. The kineFLEX fiber provides easy connection to microscopes and other analytical and biomedical instruments.

Laser performance is specified and guaranteed after the fiber. The kineFLEX SM PM fibers are offered in different lengths with either collimated or connector outputs.

Features & Benefits

Features:

- Output Beam: Combined, coaxial
- Fully independent laser control
- True Off for each wavelength
- Exceptional power stability
- Class-leading beam pointing stability
- Ultra-low noise performance
- Custom options available

Benefits:

- Easy to use, portable, turnkey system
- No laser alignment required
- Reliable and repeatable measurements
- OEM or CDRH compliant systems

iFLEX-Viper fiber coupled laser specification overview

Wavelength (nm)	640 ± 5		561 ± 2		532 ± 2		515 ± 2		488 ± 2		445 ± 5		405 ± 5	
Nomenclature	R		Y		G1		G		B		I		V	
Power after fiber (mW)	20	50	20	50	20	50	20	40	20	50	20	50	20	50
RYBV - Basic system														
Low power iFLEX-Viper-RYBV	•		•		◊		◊		•		◊		•	
High power iFLEX-Viper-RYBV		•		•		◊		◊		•		◊		•
YGBI - Basic system														
Low power iFLEX-Viper-YGBI	◊		•		◊		•		•		•		◊	
High power iFLEX-Viper-YGBI		◊		•		◊		•		•		•		◊
Noise rms (20Hz – 2 MHz)	< 0.3 % typ													
Power stability (8 hours)	< 2 %													
Spatial mode, TEM ₀₀ , M ²	M2 < 1.1 typ, diffraction limited													
Pointing stability after fiber	< 1 μrad/°C													
Polarization extinction ratio	≥ 100:1													
Max. base plate temp.	40 °C													
CW power adjustment (per λ) %	0, 0.1-100%		0, 0.1-100%		0, 0.1-100%		0, 0.1-100%		0, 0.1-100%		0, 0.1-100%		0, 0.1-100%	
Analogue modulation (per λ)	0 – 5 V		0 – 5 V		0 – 5 V		0 – 5 V		0 – 5 V		0 – 5 V		0 – 5 V	
Bandwidth	DC to 2MHz, over 3dB bandwidth frequency													
Dynamic range	≥ 30 dB													
Rise / fall time over 10 – 90%	≤ 350 ns													
Dimensions laser head	455mm (L) x 335mm (W) x 84mm (H)													
Dimensions controller	370mm (L) x 322mm (W) x 85mm (H) (or H = 91mm with feet)													

◊ Options for 5th line. Other wavelength combinations are also available.
 ◊ Fiber output options: 1m, 2m or 3m lengths, 0.7mm diameter collimated or connectors (FCP, FCP8, APC)

11

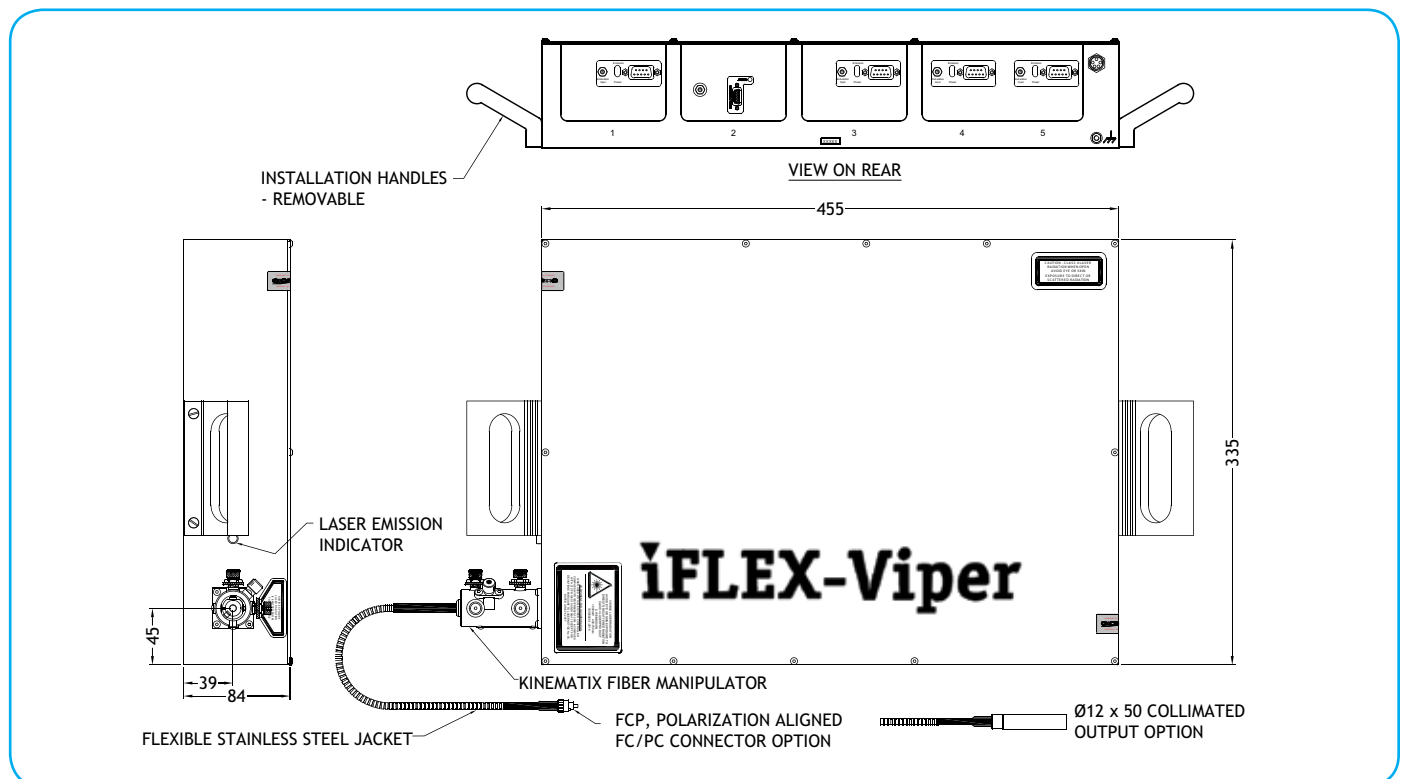

kineFLEX

Fiber Delivery Systems

The kineFLEX® is a robust SM PM fiber delivery system, suitable for use with most lasers. These single-mode, polarization-maintaining fiber delivery systems deliver the world's best beam pointing stability, making them industry standard in many imaging and precision measurement applications. This fiber delivery system includes: integrated input optics that are pre-focused and optimized for the laser, output optics or connector, and the fiber coupler.

12

kineFLEX Fibers can be coupled to most lasers:

Single λ : for diode, DPSS, gas etc.

Broadband λ : 400-640 nm

High Power: to 500mW standard or custom

Ultraviolet λ : 355 nm, 375 nm



Reasons to use a kineFLEX Fiber System

- Easy beam delivery from "A" to "B"
- Remove hot spots / side lobes / irregularities in the beam profile as the fiber acts as a spatial filter
- Class leading pointing stability $<1\mu\text{rad}/^\circ\text{C}$
- Higher power throughput levels
- Fast, and efficient instrument manufacture and servicing with detachable fiber delivery
- Reduce optical errors from multiple interfaces with integrated beam shaping
- Improve instrument stability by removing risk of bulk optic movement through integrating beam shaping optics in fiber
- Robust fiber, safely enclosed laser beam
- Compatible with different environments such as vacuum, UHC, dusty, vibrating
- Custom beam shaping integrated in fiber

Standard Option Examples

- Wavelengths: 355 nm to 852 nm
- Lengths: 1m, 2m, 3m
- Power CW: 100mW or $<500\text{mW}$
- Collimated output: 0.7mm diameter
- Connector output: FCP, APC or FCP8

OEM Custom Option Examples

- SM, PM, MM & Multi-Channel fibers
- UV-VIS-NIR and lengths to $\sim 40\text{m}$
- Integrated beam-shaping optics for elliptical, focused, collimated, flat top and parallel spot patterns
- Few Watts into VIS λ SM PM fiber
- Vacuum compatible with options for single core from air to vacuum
- Photonic crystal fiber options

kineMATIX Fiber Coupler

The kineMATIX® is the patented opto-mechanical mount used to align the laser beam into the single-mode fiber. The kineMATIX manipulator is included in the kineFLEX fiber delivery system. A kineMATIX manipulator is included with the kineFLEX Fiber Delivery Systems.

Extremely stable opto-mechanics

It has 4-axes of adjustment (X, Y, tip, tilt) and a centrally located fifth button for easy removal and insertion of the fiber. The design provides sub-micron repeatability and sub-microradian stability. This robust and thermally insensitive design enables the kineMATIX to maintain laser-to-fiber alignment across a wide temperature range and during transit. It truly offers “Set & Forget” laser to fiber alignment.

“Plug and Play” performance

For over 25 years, the iconic kineMATIX has given our customers confidence to use detachable fiber systems inside OEM instruments and in scientific research. It is the only fiber coupler to offer reliable and repeatable “Plug & Play” performance, since the alignment is retained when the fiber is removed and remains when the fiber is re-inserted.



OEM Expertise and Capabilities

Qioptiq is happy to work with our customers to ensure that each fiber system, laser system or laser engine is optimal for the application, and so we offer custom OEM solutions.

iFLEX-Hydra laser engine

An example of these high-end OEM solutions are the iFLEX-HYDRA™ laser engine systems. These are custom designed, multi-wavelength laser engines, with integrated beam-shaping on the fiber output to produce spatially separated beams. These systems effectively combine all the wavelengths needed within the smallest dimensions, and with a SM PM fiber output generating the required beam spot pattern in the flow cell or sample. They can also be paired with a collection of fiber array to maintain the smallest possible beam paths. This leads to instrument size reduction, with smaller multi-channel laser systems and typically x10 reduction in optics path length.

Engage Flexible Laser Technology™ and true development partnership

With over 25 years supporting demanding applications in industrial manufacturing, biotechnology, clinical diagnostics and semicon, Qioptiq brings design and manufacturing expertise in lasers, fiber optics and multi-line laser engines to every partnership.

kineFLEX fibers for vacuum applications

There are no “standard” vacuum compatible fibers. They are each designed and manufactured for a specific application. As well as choice of fiber lengths, operating wavelengths and optional interconnects, a complete customization service is available for OEM applications.

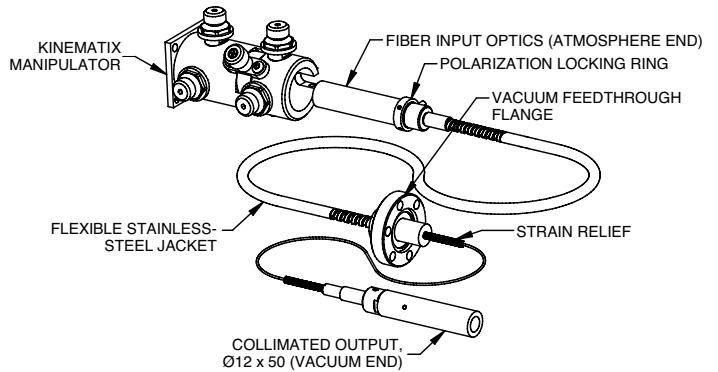

Benefits of kineFLEX fiber in vacuum environment

Replacing free space bulk optics with kineFLEX fiber optics offers some benefits such as:



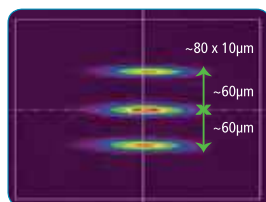
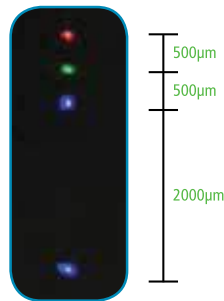

- Robust beam delivery and faster tool assembly
- Remove scattered light from vacuum window
- Retain alignment to sample during laser servicing
- Uniquely, improve pointing stability to $<1\mu\text{rad}/^\circ\text{C}$
- Uniquely, achieve a lower noise system by removing the optical noise from the bulkhead fiber-to-fiber interconnects, since a kineFLEX vacuum fiber can be made from one continuous fiber core. Hence, you can use the same fiber core from “air side” into “vacuum side” and only the fiber jacket will change at the bulkhead interface.

The vacuum section of the fiber has been designed to be compatible with low out-gassing conditions and to prevent damage through handling and integration. Every system is tested for leaks at the feedthrough, and for hydrocarbon and water outgassing.

14



The iFLEX Spectrum

Standard Maximum Output Power (mW)					
Wavelength (nm)	iFLEX-iRIS Laser 	iFLEX-iRIS Fiber Coupled Laser 	iFLEX-Gemini Laser Engine 	iFLEX-Gemini Fiber Coupled Laser Engine 	iFLEX-Viper Fiber Coupled Laser Engine 
375	50	30			
405	220	140	50	30	50
415	100	65			
445	75	50	50	30	50
458	70	45	50	30	
473	75	50			
488	140	90	50	30	50
505	50	30			
515	60	40	50	30	40
520	30	20			
532	40	25			50
561	40	25	30	20	50
594	20	12			
633	70	45			
640	150	95	50	30	50
647	50	30	50	30	
660	80	50			
670	10	6			
730	20	10			
780	70	45			
852	35	20			



Discover the Q!

Qioptiq delivers cutting-edge technology for all photonic and optical requirements of OEM System development and scientific research alike. Global production capabilities and state-of-the-art manufacturing guarantee an impressive portfolio of products and solutions. Discover the Q for high-performance solid-state laser systems and fiber optics.

Photonics for Innovation

Contact Qioptiq today:

North America
+1 (800) 429 0257

United Kingdom
+44 (0) 2380 744 500

Europe
+49 551 69 35-0

Asia/Pacific
+65 64 99 77 77

qioptiq.com
qioptiq-shop.com
LASERS@excelitas.com

