

Solid State Relays

Industrial, 1-Phase ZS, Standard Range

Types RA 24.. .. 06/RA 44.. .. 08/RA 48.. .. 12



- AC Solid State Relay
- Zero switching
- Direct copper bonding technology
- Rated operational current: 25, 50 and 90 AACrms
- Blocking voltage: Up to 1200 V_p
- Rated operational voltage: Up to 480 VACrms
- 3 input ranges: 3 to 32 VDC, 10 to 90 VAC/DC and 90 to 280 VAC/DC
- Isolation: OPTO (input-output) 4000 VACrms



Product Description

The zero switching relay with antiparallel thyristor output is the most widely used industrial SSR due to its multiple application possibilities. The relay can be used for resis-

tive, inductive and capacitive loads. The zero switching relay switches ON when the sine curve just crosses zero and switches OFF when the current crosses zero.

Ordering Key

RA 24 25 LA 06

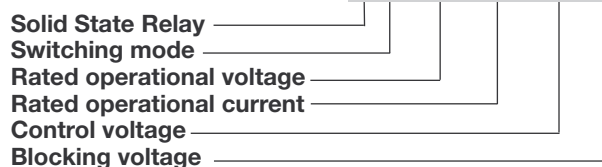

Type Selection

Switching mode	Rated operational voltage	Rated operational current	Control voltage	Blocking voltage
A: Zero switching	24: 230 VACrms 44: 400 VACrms 48: 480 VACrms	25: 25 AACrms 50: 50 AACrms 90: 90 AACrms	D: 3 to 32 VDC LA: 10 to 90 VAC/DC HA: 90 to 280 VAC/DC	06: 650 V _p 08: 850 V _p 12: 1200 V _p

Selection Guide

Rated operational voltage	Blocking voltage	Control voltage	Rated operational current		
			25 AACrms	50 AACrms	90 AACrms
230 VACrms	650 V _p	3 to 32 VDC	RA 2425 -D 06	RA 2450 -D 06	RA 2490 -D 06
		10 to 90 VAC/DC	RA 2425 LA 06	RA 2450 LA 06	RA 2490 LA 06
		90 to 280 VAC/DC	RA 2425 HA 06	RA 2450 HA 06	RA 2490 HA 06
400 VACrms	850 V _p	3 to 32 VDC	RA 4425 -D 08	RA 4450 -D 08	RA 4490 -D 08
		10 to 90 VAC/DC	RA 4425 LA 08	RA 4450 LA 08	RA 4490 LA 08
		90 to 280 VAC/DC	RA 4425 HA 08	RA 4450 HA 08	RA 4490 HA 08
480 VACrms	1200 V _p	3 to 32 VDC	RA 4825 -D 12	RA 4850 -D 12	RA 4890 -D 12
		10 to 90 VAC/DC	RA 4825 LA 12	RA 4850 LA 12	RA 4890 LA 12
		90 to 280 VAC/DC	RA 4825 HA 12	RA 4850 HA 12	RA 4890 HA 12



General Specifications

	RA 24.. .. 06	RA 44.. .. 08	RA 48.. .. 12
Operational voltage range	24 to 280 VACrms	42 to 480 VACrms	42 to 530 VACrms
Blocking voltage	$\geq 650 V_p$	$\geq 850 V_p$	$\geq 1200 V_p$
Zero voltage turn-on	$\leq 20 V$	$\leq 40 V$	$\leq 40 V$
Operational frequency range	45 to 65 Hz	45 to 65 Hz	45 to 65 Hz
Power factor	$\geq 0.5 @ 230 VACrms$	$\geq 0.5 @ 400 VACrms$	$\geq 0.5 @ 480 VACrms$
Approvals	CE, cURus, CSA, EAC	CE, cURus, CSA, EAC	CE, cURus, CSA, EAC

Output Specifications

	RA..25	RA ..50	RA ..90
Rated operational current AC 51 AC 53a	25 Arms 5 Arms	50 Arms 15 Arms	90 Arms 20 Arms
Minimum operational current	150 mArms	250 mArms	400 mArms
Rep. overload current t=1 s	$\leq 55 Arms$	$\leq 125 Arms$	$\leq 150 Arms$
Non-rep. surge current t=10 ms	325 A _p	600 A _p	1150 A _p
Off-state leakage current @ rated voltage and frequency	$\leq 3 mArms$	$\leq 3 mArms$	$\leq 3 mArms$
I ² t for fusing t=10 ms	$\leq 525 A^2s$	$\leq 1800 A^2s$	$\leq 6600 A^2s$
On-state voltage drop @ rated current	$\leq 1.6 Vrms$	$\leq 1.6 Vrms$	$\leq 1.6 Vrms$
Critical dV/dt commutating	$\geq 500 V/\mu s$	$\geq 500 V/\mu s$	$\geq 500 V/\mu s$
Critical dV/dt off-state	$\geq 500 V/\mu s$	$\geq 500 V/\mu s$	$\geq 500 V/\mu s$

Input Specifications

	RA -D ..	RA LA ..	RA HA ..
Control voltage range	3 to 32 VDC	10 to 90 VAC/DC	90 to 280 VAC/DC
Pick-up voltage	$\leq 3 VDC$	$\leq 10 VAC/DC$	$\leq 90 VAC/DC$
Drop-out voltage	$\geq 1 VDC$	$\geq 1 VAC/DC$	$\geq 10 VAC/DC$
Reverse voltage	$\leq 32 VDC$		
Input impedance	1.5 k Ω	5.4 k Ω	44 k Ω
Response time pick-up	$\leq 1/2$ cycle	≤ 1 cycle	≤ 1 cycle
Control pulse width	$\geq 0.5 ms$	$\geq 0.5 ms$	$\geq 0.5 ms$
Response time drop-out	$\leq 1/2$ cycle	$\leq 1/2$ cycle	$\leq 1/2$ cycle



Isolation

Rated isolation voltage Input to output	≥ 4000 VACrms
Rated isolation voltage Output to case	≥ 4000 VACrms
Insulation resistance Input to output	≥ 10 ¹⁰ Ω
Insulation resistance Output to case	≥ 10 ¹⁰ Ω
Insulation capacitance Input to output	≤ 8 pF
Insulation capacitance Output to case	≤ 100 pF

Housing Specifications

Weight	Approx. 110 g	
Housing material	Noryl GFN 1, black	
Base plate	25, 50 A 90 A	Aluminium, nickel-plated Copper, nickel-plated
Potting compound	Polyurethane	
Relay		
Mounting screws	M5	
Mounting torque	≤ 1.5 Nm	
Control terminal		
Mounting screws	M3 x 6	
Mounting torque	≤ 0.5 Nm	
Power terminal		
Mounting screws	M5 x 6	
Mounting torque	≤ 2.4 Nm	

Functional Diagram

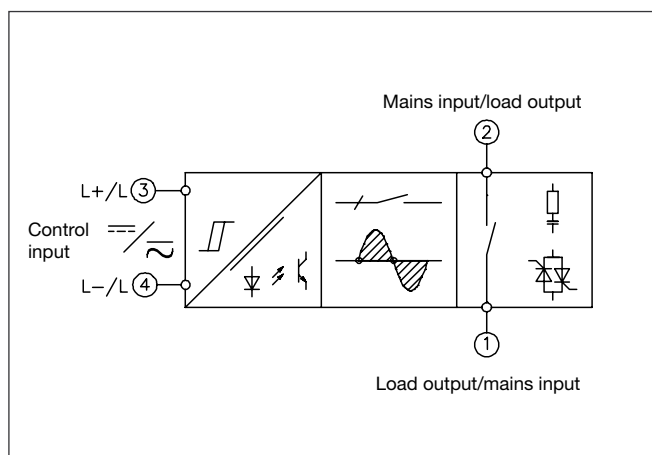

Dimensions

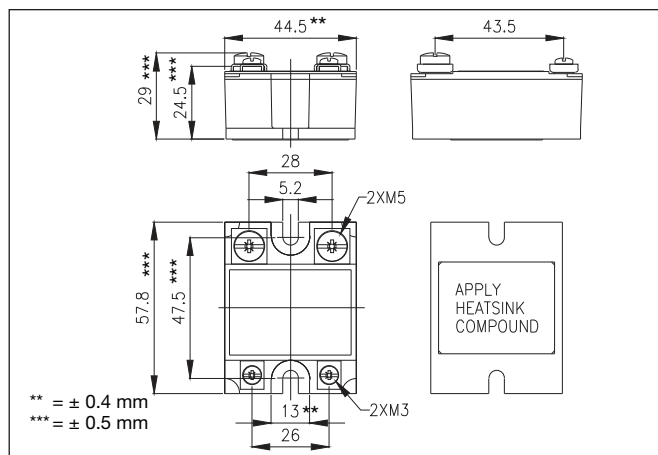

All dimensions in mm

Connection Diagram

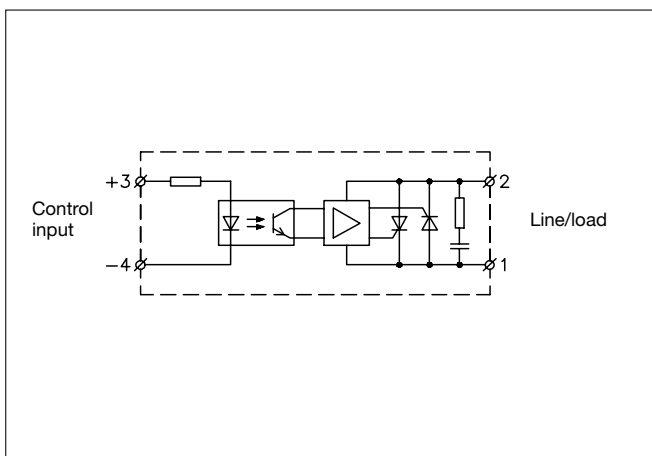



Heatsink Dimensions (load current versus ambient temperature)

RA ..25

Load current [A]	Thermal resistance [°C/W]						Power dissipation [W]
	20	30	40	50	60	70	
25	2	1.7	1.4	1	0.71	0.40	32
22.5	2.5	2.1	1.8	1.4	1	0.66	27
20	3.1	2.7	2.3	1.9	1.4	1	23
17.5	4.	3.5	3	2.5	2	1.4	20
15	4.9	4.3	3.7	3.1	2.5	1.9	16
12.5	6.2	5.4	4.6	3.9	3.1	2.3	13
10	8.1	7.1	6.1	5.1	4	3	10
7.5	11.3	9.9	8.5	7.1	5.6	4.2	7
5	-	15.6	13.3	11.1	8.9	6.7	5
2.5	-	-	-	-	18.7	14	2

T_A
Ambient temp. [°C]

RA ..50

Load current [A]	Thermal resistance [°C/W]						Power dissipation [W]
	20	30	40	50	60	70	
50	0.92	0.76	0.60	0.45	0.29	-	63
45	1.2	0.99	0.80	0.62	0.44	0.26	55
40	1.5	1.3	1.1	0.85	0.63	0.42	47
35	1.9	1.6	1.4	1.1	0.89	0.63	40
30	2.4	2.1	1.8	1.5	1.2	0.91	33
25	3	2.7	2.3	1.9	1.5	1.1	26
20	3.9	3.5	3	2.5	2	1.5	20
15	5.5	4.8	4.1	3.4	2.7	2.1	15
10	8.6	7.5	6.4	5.4	4.3	3.2	9
5	17.9	15.6	13.4	11.2	8.9	6.7	4

T_A
Ambient temp. [°C]

RA ..90

Load current [A]	Thermal resistance [°C/W]						Power dissipation [W]
	20	30	40	50	60	70	
90	0.63	0.53	0.42	0.32	-	-	97
80	0.81	0.69	0.57	0.45	0.33	-	84
70	1	0.89	0.75	0.61	0.47	0.33	71
60	1.3	1.2	1	0.83	0.66	0.49	59
50	1.7	1.5	1.3	1.1	0.85	0.64	47
40	2.2	1.9	1.7	1.4	1.1	0.83	36
30	3.1	2.7	2.3	1.9	1.5	1.2	26
20	4.8	4.2	3.6	3	2.4	1.8	17
10	10	8.8	7.5	6.3	5	3.8	8

T_A
Ambient temp. [°C]

Heatsink Selection

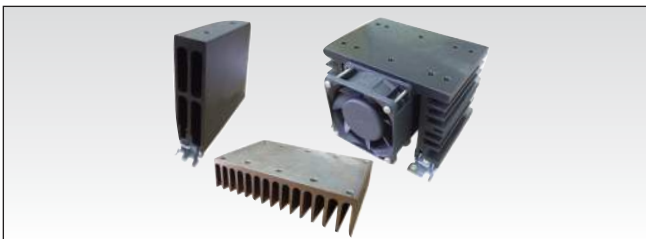

Heatsink Range Overview:
http://www.productselection.net/PDF/UK/ssr_accessories.pdf

Heatsink Selector Tool:
<http://www.productselection.net/heatsink/heatsinkselector.php?LANG=UK>

Ordering Key

RHS..

- Heatsinks and fans
- 5.40°C/W to 0.12°C/W thermal resistance
- DIN, panel or thru wall mounting
- Single or multiple SSR mounting

Applications

This relay is designed for use in applications in which it is exposed to high surge conditions. Care must be taken to ensure proper heatsinking when the relay is to be used at high sustained currents. Adequate electrical connection between relay terminals and cable must be ensured.

Thermal characteristics

The thermal design of Solid State Relays is very impor-

tant. It is essential that the user makes sure that cooling is adequate and that the maximum junction temperature of the relay is not exceeded.

If the heatsink is placed in a small closed room, control panel or the like, the power dissipation can cause the ambient temperature to rise. The heatsink is to be calculated on the basis of the ambient temperature and the increase in temperature.

Direct bonding
In the design of the output power semiconductor direct bonding of the copper layer and the ceramic substrate has been applied. This is to ensure uninhibited heat transfer and high thermal fatigue strength.

The relay has been designed for applications requiring large numbers of load cycles.

Power dissipation

The power dissipation for intermittent use is calculated according to the following formula:

$$I_{rms} = \sqrt{\frac{I_{ON}^2 \times t_{ON}}{t_{ON} + t_{OFF}}}$$

Ex: RA 24 50 -D 06:
Load current = 45 A
 $t_{ON} = 30$ s
 $t_{OFF} = 15$ s

$$I_{rms} = \sqrt{\frac{45^2 \times 30}{30 + 15}}$$

The rms current will be 36.7 A.

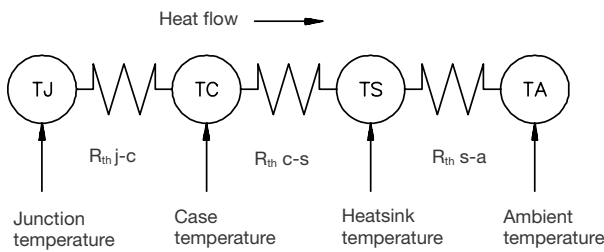

Thermal resistance:
 $R_{th j-c}$ = junction to case

$R_{th c-s}$ = case to heatsink
 $R_{th s-a}$ = heatsink to ambient

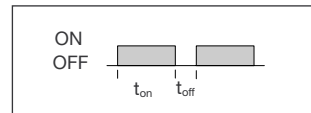

Thermal Specifications

	RA ..25	RA ..50	RA ..90
Operating temperature	-20° to +70°C (-4° to +158°F)	-20° to +70°C (-4° to +158°F)	-20° to +70°C (-4° to +158°F)
Storage temperature	-40° to +100°C (-40° to +212°F)	-40° to +100°C (-40° to +212°F)	-40° to +100°C (-40° to +212°F)
Junction temperature	≤ 125°C (≤ 257°F)	≤ 125°C (≤ 257°F)	≤ 125°C (≤ 257°F)
R_{th} junction to case	≤ 1.25°C/W	≤ 0.65°C/W	≤ 0.3°C/W
R_{th} junction to ambient	≤ 12°C/W	≤ 12°C/W	≤ 12°C/W

Environmental Specifications

Pollution degree	2 (non-conductive pollution with possibilites of condensation)
EU RoHS compliant	Yes
China RoHS compliant	Refer to Environmental Information (Page 6)



Environmental Information

The declaration in this section is prepared in compliance with People’s Republic of China Electronic Industry Standard SJ/T11364-2014: Marking for the Restricted Use of Hazardous Substances in Electronic and Electrical Products.

Part Name	Toxic or Harardous Substances and Elements					
	Lead (Pb)	Mercury (Hg)	Cadmium (Cd)	Hexavalent Chromium (Cr(VI))	Polybrominated biphenyls (PBB)	Polybrominated diphenyl ethers (PBDE)
Power Unit Assembly	x	○	○	○	○	○
O: Indicates that said hazardous substance contained in homogeneous materials fot this part are below the limit requirement of GB/T 26572. X: Indicates that said hazardous substance contained in one of the homogeneous materials used for this part is above the limit requirement of GB/T 26572.						

环境特性

这份申明根据中华人民共和国电子工业标准 SJ/T11364-2014：标注在电子电气产品中限定使用的有害物质

零件名称	有毒或有害物质与元素					
	铅 (Pb)	汞 (Hg)	镉 (Cd)	六价铬 (Cr(VI))	多溴化联苯 (PBB)	多溴联苯醚 (PBDE)
功率单元	x	○	○	○	○	○
O:此零件所有材料中含有的该有害物低于GB/T 26572的限定。 X: 此零件某种材料中含有的该有害物高于GB/T 26572的限定。						



Accessories

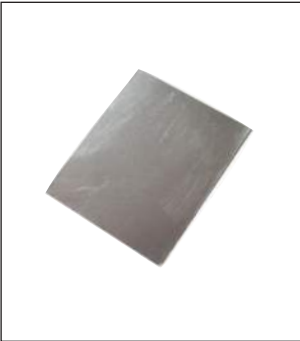

- Graphite thermal pad with adhesive on one side
- Type KK071CUT
- Dimensions: 35 x 43 x 0.25 mm
- Packing quantity: 50 pcs.

All accessories can be ordered pre-assembled with Solid State Relays.
Other accessories include DIN rail adaptors and varistors

For further information refer to Accessories datasheets at:
www.productselection.net/PDF/UK/SSR_Accessories.pdf