

## UNI HALL click™

### 1. Introduction

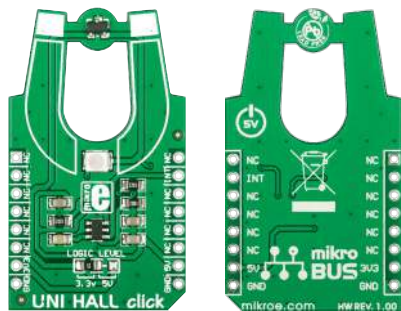

UNI HALL click™ is a simple solution for adding an unipolar Hall switch to your design. It carries the Melexis US5881 unipolar Hall-effect switch and a 74LVC1T45 single bit, dual supply translating transceiver. UNI HALL click™ communicates with the target board through the **mikroBUS™** INT line. The board is designed to use either a 3.3V or 5V power supply (which also defines the logic level of the output signal).

### 2. Soldering the headers

Before using your click™ board, make sure to solder 1x8 male headers to both left and right side of the board. Two 1x8 male headers are included with the board in the package.

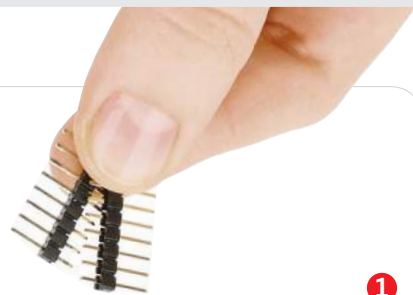

1

2

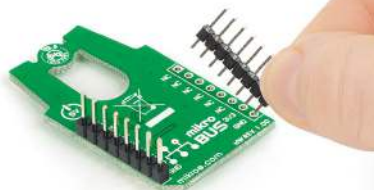

Turn the board upside down so that the bottom side is facing you upwards. Place shorter pins of the header into the appropriate soldering pads.

3

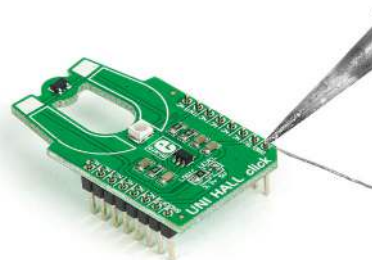

Turn the board upward again. Make sure to align the headers so that they are perpendicular to the board, then solder the pins carefully.

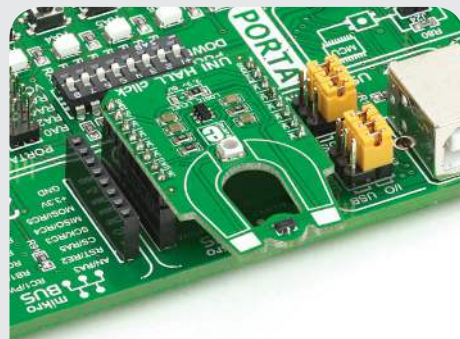

### 4. Essential features

The unipolar Hall effect sensor on UNI HALL click™ is sensitive to north pole magnetic fields—when exposed to such a field, it outputs a LOW logic level. Otherwise the output is a HIGH logic level. In its simplest application, UNI HALL click™ can be employed as part of a long lasting contactless proximity switch. However, magnets can be employed in various ways to infer the speed, position, or other properties of an object; there are countless ways to utilize UNI HALL click™ in your design.

### 3. Plugging the board in

Once you have soldered the headers your board is ready to be placed into the desired mikroBUS™ socket. Make sure to align the cut in the lower-right part of the board with the markings on the silkscreen at the mikroBUS™ socket. If all the pins are aligned correctly, push the board all the way into the socket.

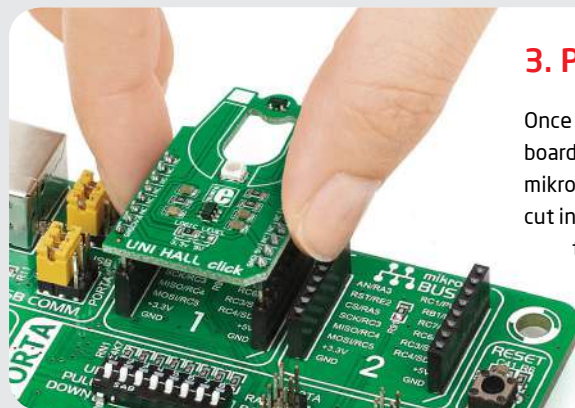

click™  
BOARD  
[www.mikroe.com](http://www.mikroe.com)

UNI HALL click™ manual  
ver. 1.00



0 10000 026939

## 5. UNI HALL click™ board schematic

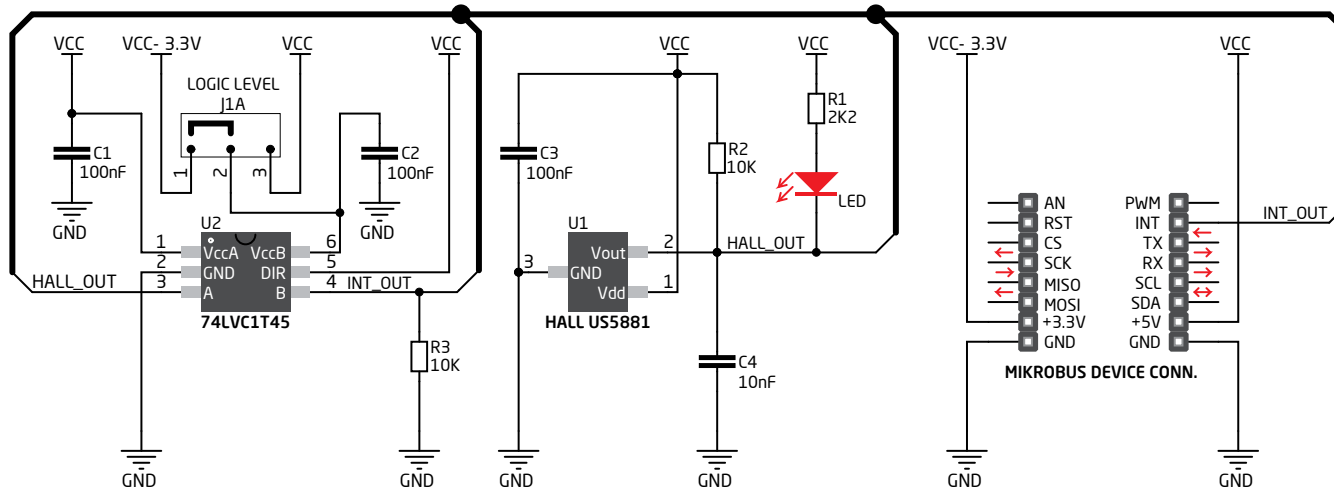

MikroElektronika assumes no responsibility or liability for any errors or inaccuracies that may appear in the present document. Specification and information contained in the present schematic are subject to change at any time without notice. Copyright © 2014 MikroElektronika. All rights reserved.

## 6. SMD jumper



To switch between 3.3V and 5V power supplies, use the on-board zero-ohm SMD jumper. By default it's soldered in the 3.3V position.

## 7. Code examples

Once you have done all the necessary preparations, it's time to get your click™ board up and running. We have provided examples for mikroC™, mikroBasic™ and mikroPascal™ compilers on our **Libstock** website. Just download them and you are ready to start.



## 8. Support

MikroElektronika offers **free tech support** ([www.mikroe.com/support](http://www.mikroe.com/support)) until the end of the product's lifetime, so if something goes wrong, we're ready and willing to help!