

Click to  
**ORDER**  
samples

## AME30-480JZ



Encapsulated

The AME30-480JZ is a new ultra-wide input AC-DC converter series featuring a cost effective, energy efficient solution. The products offer a high level of stability and immunity to noise, designed to meet IEC/EN/UL62368-1 and IEC/EN61558-1 standards. These ultra-wide input AC-DC converters also have an extremely compact design for space saving and are ideal for applications such as industrial control equipment machinery and numerous applications for harsh environments.

This new series offers great operating temperatures, from -40°C to 85°C and an isolation of 4000VAC for improved reliability and system safety. Furthermore, a high MTBF of 950,000h, output short circuit protection (OSCP), output over-current protection (OCP) and an output over-voltage protection (OVP) come standard with the series.

## Features

- Wide Input: 176 - 528VAC/248 - 746VDC
- Operating Temp: -40 °C to +85 °C
- High isolation voltage: 4000VAC
- Low ripple & noise, 150mV(p-p), max.
- Output short circuit, over-current, over-voltage protection
- Overvoltage category III (OVC III)

## Summary

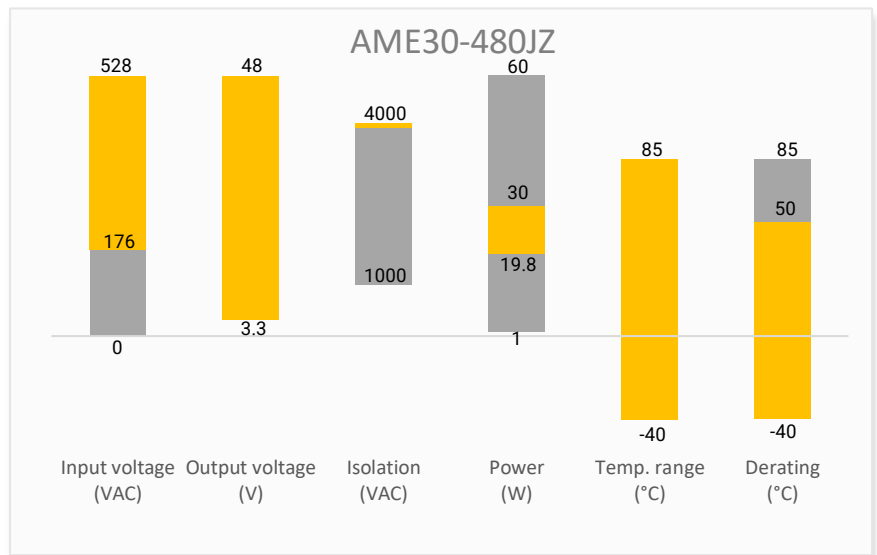

## Training



Product Training Video  
(click to open)

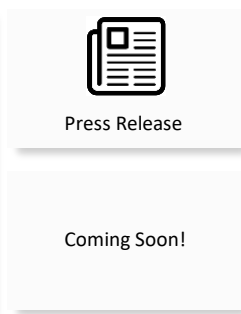

Application Notes

## Applications



Power Grid



Industrial



Telecom



Instrumentation

## Models & Specifications

Single Output							
Model	Input Voltage (VAC/Hz)	Input Voltage (VDC)	Max Output wattage (W)	Output Voltage (V)	Output Current max (A)	Maximum capacitive load ( $\mu$ F)	Efficiency @ 230VAC Typ. (%)
AME30-3S480JZ	176 - 528/47 - 63	248 - 746	19.8	3.3	6	15000	82
AME30-5S480JZ	176 - 528/47 - 63	248 - 746	30	5	6	15000	84
AME30-9S480JZ	176 - 528/47 - 63	248 - 746	30.06	9	3.34	8200	85
AME30-12S480JZ	176 - 528/47 - 63	248 - 746	30	12	2.5	4700	85
AME30-15S480JZ	176 - 528/47 - 63	248 - 746	30	15	2	3300	85
AME30-24S480JZ	176 - 528/47 - 63	248 - 746	30	24	1.25	1500	86
AME30-48S480JZ	176 - 528/47 - 63	248 - 746	30	48	0.625	820	88

Input Specifications				
Parameters	Conditions	Typical	Maximum	Units
Input Current	230VAC		500	mA
	380VAC		350	mA
Inrush Current	230VAC	35		A
	380VAC	60		A
Leakage Current	480VAC/50Hz		0.5	mA RMS
Fuse	Required external fuse		3.15A/500V, slow-blow	

Output Specifications				
Parameters	Conditions	Typical	Maximum	Units
Voltage accuracy	3.3Vout models	$\pm 3$		%
	Other models	$\pm 2$		%
Line regulation	100% load, 3.3Vout models	$\pm 1$		%
	100% load, other models	$\pm 0.5$		%
Load regulation	0-100% load, 3.3Vout models	$\pm 2$		%
	0-100% load, other models	$\pm 1$		%
Ripple & Noise	20MHz bandwidth	80	150	mV p-p
Hold up time	230VAC	45		ms
	380VAC	120		ms

Isolation Specifications				
Parameters	Conditions	Typical	Maximum	Units
Tested I/O voltage	60 sec, Leakage current < 5mA	4000		VAC

General Specifications				
Parameters	Conditions	Typical	Maximum	Units
Overvoltage category	OVC III			
Over Current protection	Auto- recovery	≥ 110		% of Iout
Over voltage protection	Voltage clamp or hiccup, 3.3/5 VDC Output	≤ 7.5		VDC
	Voltage clamp or hiccup, 9/12 VDC Output	≤ 16		VDC
	Voltage clamp or hiccup, 15 VDC Output	≤ 25		VDC
	Voltage clamp or hiccup, 24 VDC Output	≤ 35		VDC
	Voltage clamp or hiccup, 48 VDC Output	≤ 60		VDC
Short circuit protection	Hiccup, Continuous, Auto-recovery			
No load power consumption	230VAC		0.3	W
	380VAC		0.5	W
Switching Frequency		65		KHz
Operating temperature		-40 to +85		°C
Storage temperature		-40 to +85		°C
Wave soldering temperature	Duration 5 - 10s	260		°C
Manual soldering temperature	Duration 3 - 5s	360		°C
Power derating	55°C to 70°C	3.0		% / °C
	70°C to 85°C	1.33		% / °C
Protection Class	Class II			
Cooling	Free air convection			
Storage Humidity			95	% RH
Case material	Heat resistant black Plastic (flammability to UL 94V-0)			
Weight		152		g
Dimensions (L x W x H)	2.76 x 1.89 x 1.18 inches (70.00 x 48.00 x 30.00 mm)			
MTBF	> 950 000 hrs (MIL-HDBK -217F, t=+25°C)			
NOTE: All specifications in this datasheet are measured at an ambient temperature of 25°C, humidity<75%, nominal input voltage and at rated output load unless otherwise specified.				

Safety Specifications		
Parameters		
Standards	Designed to meet IEC/EN/UL 62368-1, IEC/EN61558-1	
	EMC - Conducted and radiated emission	CISPR32 / EN55032, Class B
	Electrostatic Discharge Immunity	IEC 61000-4-2 Air ±8KV, Contact ±6KV, Criteria A
	RF, Electromagnetic Field Immunity	IEC 61000-4-3 10V/m, Criteria A
	Electrical Fast Transient/Burst Immunity	IEC 61000-4-4 ±2KV, Criteria A IEC 61000-4-4 ±4KV, Criteria A with the typical application circuit or EMC circuit
	Surge Immunity	IEC 61000-4-5 L-L ±2KV, Criteria A with the typical application circuit IEC 61000-4-5 L-L ±4KV, Criteria A with the EMC circuit 1 IEC 61000-4-5 L-L ±2KV, L-G ±4KV, Criteria A with the EMC circuit 2
	CS, Conducted Disturbance Immunity	IEC 61000-4-6 10V r.m.s, Criteria A
	Voltage dips, Short Interruptions Immunity	IEC 61000-4-11 0%, 70%, Criteria A

## Derating

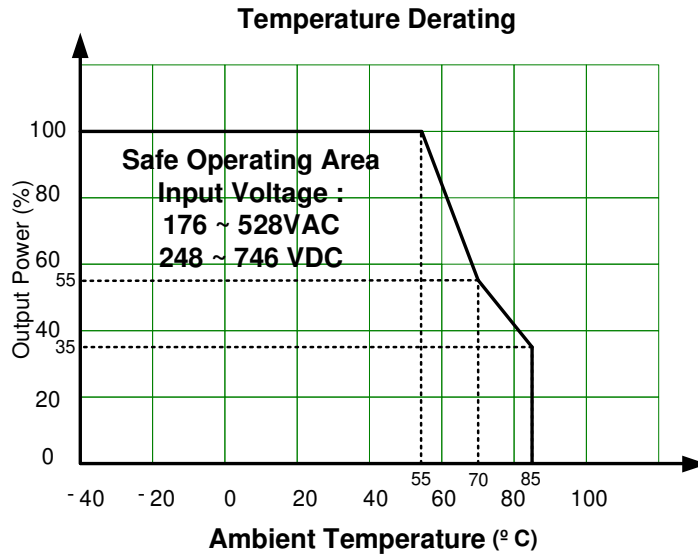

## Typical Application Circuit

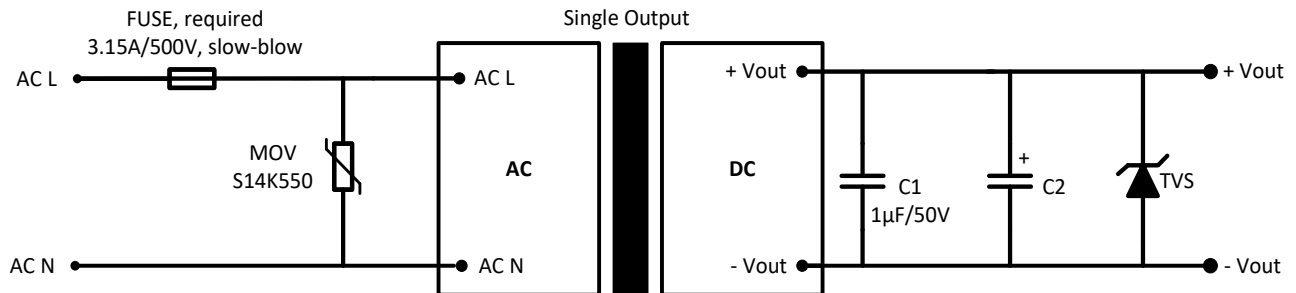

Model	C2	TVS
3.3Vout	330µF/25V	7V
5Vout	330µF/25V	7V
9Vout	220µF/25V	12V
12Vout	220µF/25V	20V
15Vout	220µF/35V	30V
24Vout	220µF/35V	30V
48Vout	10µF/63V	64V

For filtering components:

Choose capacitors with at least 20% voltage margin. The C2 capacitor is recommended to use electrolytic type with high frequency and low ESR rating. The C1 capacitor is recommended to use ceramic type for filtering high-frequency noise.

## Recommended EMC Circuit 1

3 phase 4 wire full-wave rectification for 4KV differential mode inrush standard

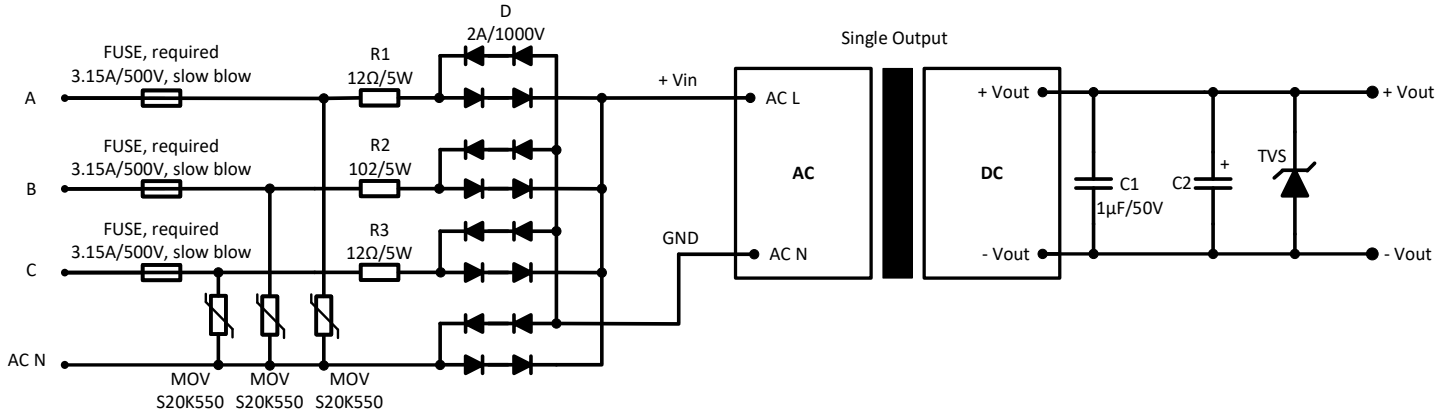

R1, R2, R3  
12Ω/5W (wire-wound resistor)

## Recommended EMC Circuit 2

Class I equipment

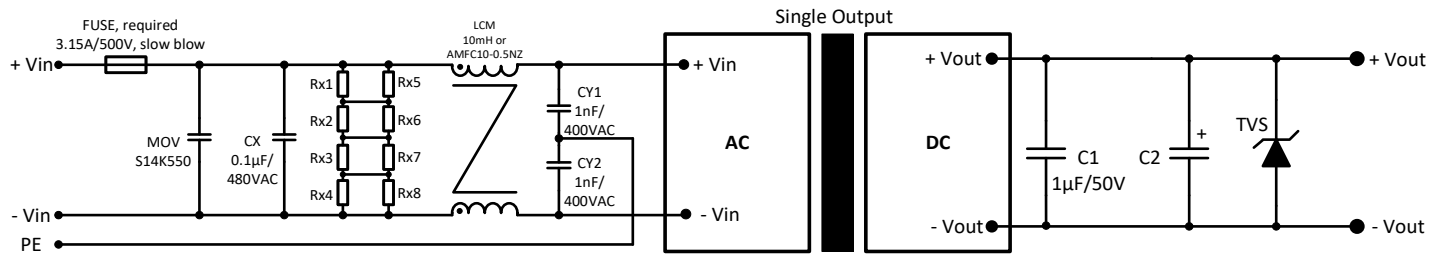

Rx1, Rx2, Rx3, Rx4, Rx5, Rx6  
Recommend < 2.5MΩ

## Dimensions

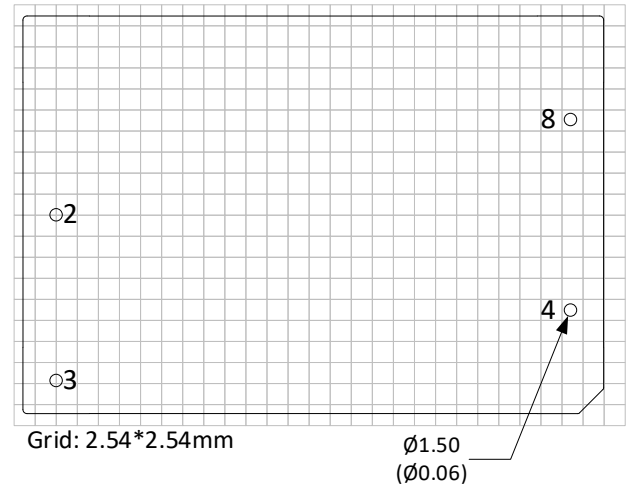
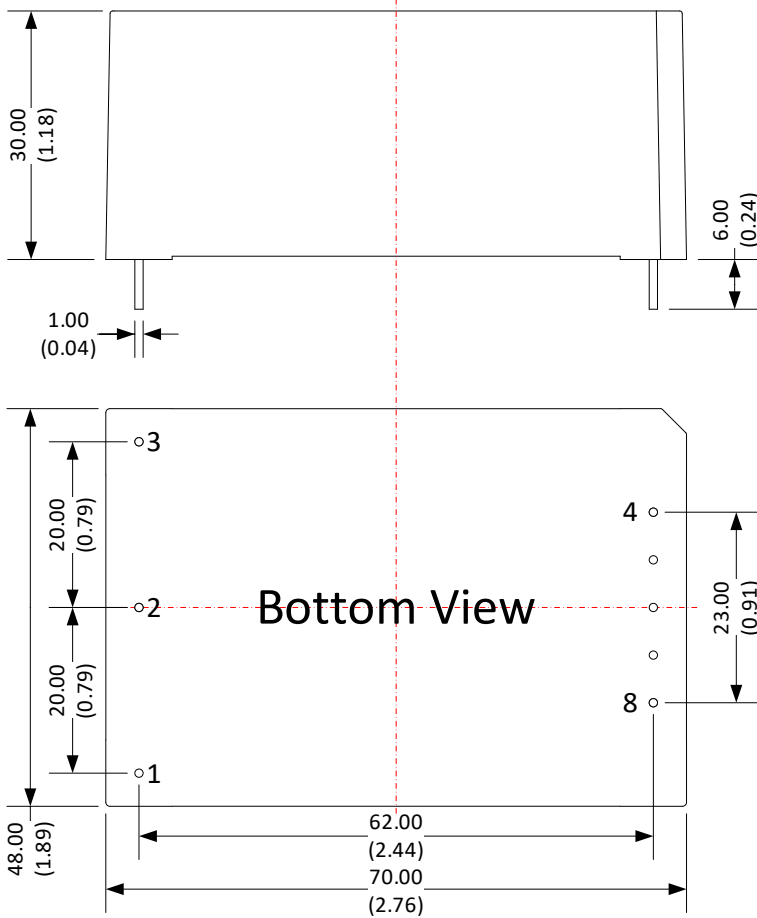

Note:  
Unit: mm (inch)  
General tolerance: ±0.1 (0.004)  
Pin tolerance: ±0.5 (0.02)

Pin Output Specifications	
Pin	Function
1	No pin
2	Input (N)
3	Input (L)
4	+V Output
8	-V Output

**NOTE:** 1. Datasheets are updated as needed and as such, specifications are subject to change without notice. Once printed or downloaded, datasheets are no longer controlled by Aimtec; refer to [www.aimtec.com](http://www.aimtec.com) for the most current product specifications. 2. Product labels shown, including safety agency certifications on labels, may vary based on the date manufactured. 3. Mechanical drawings and specifications are for reference only. 4. All specifications are measured at an ambient temperature of 25°C, humidity<75%, nominal input voltage and at rated output load unless otherwise specified. 5. Aimtec may not have conducted destructive testing or chemical analysis on all internal components and chemicals at the time of publishing this document. CAS numbers and other limited information are considered proprietary and may not be available for release. 6. This product is not designed for use in critical life support systems, equipment used in hazardous environments, nuclear control systems or other such applications which necessitate specific safety and regulatory standards other the ones listed in this datasheet. 7. Warranty is in accordance with Aimtec's standard Terms of Sale available at [www.aimtec.com](http://www.aimtec.com).