



The Future of Analog IC Technology®

# EVQ4560-Q-00A

2A, 55V, 2MHz

## Step-Down Converter Evaluation Board

### DESCRIPTION

The EVQ4560-Q-00A is an evaluation board for the MPQ4560, a high frequency step-down regulator with an integrated power MOSFET.

The MPQ4560 integrates a 250mΩ MOSFET that provides 2A load current over a wide operating input voltage of 4.5V to 55V.

Current mode control provides fast transient response and eases loop stabilization. An internal soft-start prevents inrush current at turn-on.

The EVQ4560-Q-00A is a fully assembled and tested PCB. It generates a +5V output voltage at load current up to 2A from an 8V to 55V input range. Switching frequency is set at 700kHz.

### ELECTRICAL SPECIFICATIONS

Parameter	Symbol	Value	Units
Input Voltage	$V_{IN}$	8 – 55	V
Output Voltage	$V_{OUT}$	5	V
Output Current	$I_{OUT}$	2	A

### FEATURES

- 2A Output Current
- Programmable Switching Frequency up to 2MHz
- Wide 8V to 55V Operating Input Range
- Adjustable Output from 0.8V
- Fully Assembled and Tested

### APPLICATIONS

- High Voltage Power Conversion
- Game Machines
- Automotive Systems
- Industrial Power Systems
- Distributed Power Systems
- Printer Systems
- Battery Powered Systems

All MPS parts are lead-free and adhere to the RoHS directive. For MPS green status, please visit MPS website under Quality Assurance. "MPS" and "The Future of Analog IC Technology" are Registered Trademarks of Monolithic Power Systems, Inc.

### EVQ4560-Q-00A EVALUATION BOARD

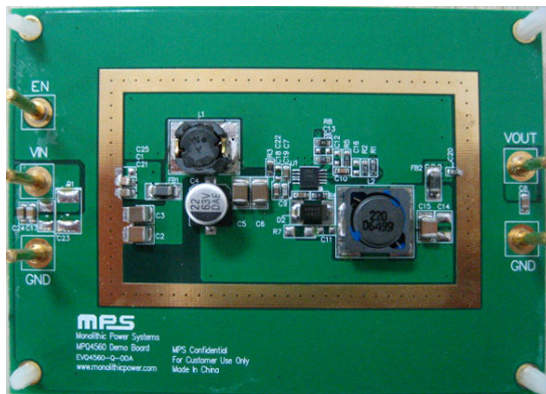

(L x W x H) 3.5" x 2.5" x 0.4"  
(8.8cm x 6.4cm x 1.0cm)

Board Number	MPS IC Number
EVQ4560-Q-00A	MPQ4560DQ

### Efficiency vs. Load Current

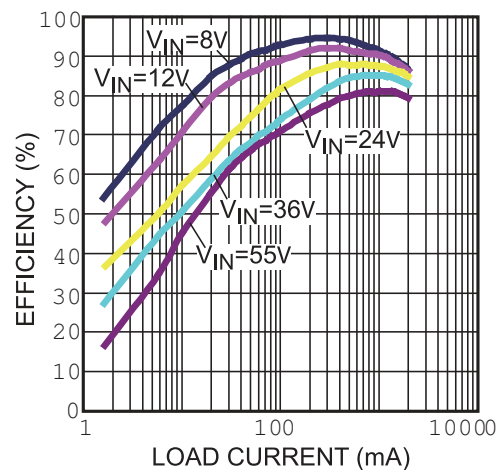

## EVALUATION BOARD SCHEMATIC

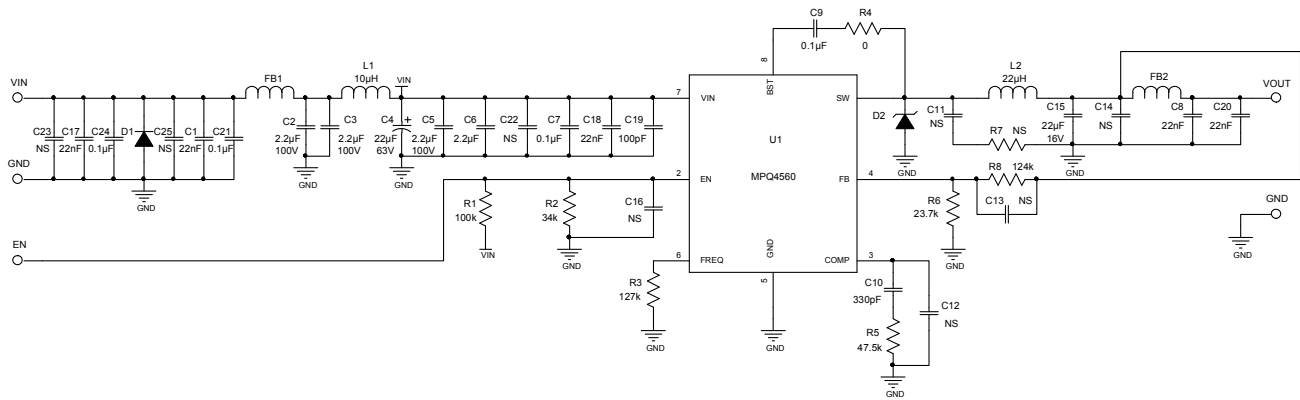

## EVQ4560-Q-00A BILL OF MATERIALS

Qty	RefDes	Value	Description	Package	Manufacturer	Manufacturer_P/N
2	C1, C17	22nF	Ceramic Capacitor; 100V; X7R; 0805	0805	TDK	C2012X7R2A223K
4	C2, C3, C5, C6	2.2µF	Ceramic Capacitor; 100V; X7R; 1210	1210	TDK	C3225X7R2A225K
1	C4	22µF	Electrolytic Capacitor; 63V; Φ6.3mmx7.7mm (H)	SMD	Jianghai	VTD-63V22
			Electrolytic Capacitor; 63V; 6.6mmx6.6mm	SMD	Panasonic	EEH-ZC1J220XP
2	C7, C9	0.1µF	Ceramic Capacitor; 100V; X7R; 0603	0603	muRata	GRM188R72A104KA35D
1	C8	22nF	Ceramic Capacitor; 50V; X7R; 0805	0805	TDK	C2012X7R1H223K
1	C10	330pF	Ceramic Capacitor; 50V; X7R; 0603	0603	TDK	C1608X7R1H331K
1	C15	22µF	Ceramic Capacitor; 16V; X7R; 1210	1210	TDK	C3235X7R1C226M
1	C18	22nF	Ceramic Capacitor; 100V; X7R; 0603	0603	TDK	C1608X7R2A223K
1	C19	100pF	Ceramic Capacitor; 100V; C0G; 0603	0603	TDK	C1608C0G2A101J
1	C20	22nF	Ceramic Capacitor; 50V; X7R; 0603	0603	TDK	C1608X7R1H223K
2	C21, C24	0.1µF	Ceramic Capacitor; 100V; X7R; 0805	0805	TDK	C2012X7R2A104K
2	C11, C25	NS		0805		
4	C12, C13, C16, C22	NS		0603		
2	C14, C23	NS		1210		
1	D1	NS		SMB		
1	D2	B260A	Diode Schottky; 60V; 2A	SMA	Diodes	B260A

**EVQ4560-Q-00A BILL OF MATERIALS (continued)**

Qty	RefDes	Value	Description	Package	Manufacturer	Manufacturer_P/N
5	EN, GND1, GND2, VIN, VOUT		2.0 Golden Pin		HZ	
2	FB1, FB2		Magnetic Bead; 6A	1206	muRata	BLM31PG330SH1L
1	L1	10µH	Inductor; 2.4A	SMD	TOKO	DS85LCB-B1135AS-100M
1	L2	22µH	Inductor; 3A	SMD	TOKO	D104C-919AS-220M
1	R1	100k	Film Resistor; 1%	0603	Yageo	RC0603FR-07100KL
1	R2	34k	Film Resistor; 1%	0603	Yageo	RC0603FR-0734KL
1	R3	127k	Film Resistor; 1%	0603	Yageo	RC0603FR-07127KL
1	R4	0	Film Resistor; 5%	0603	Yageo	RC0603JR-070RL
1	R5	47.5k	Film Resistor; 1%	0603	Yageo	RC0603FR-0747K5L
1	R6	23.7k	Film Resistor; 1%	0603	Yageo	RC0603FR-0723K7L
1	R7	NS		0603		
1	R8	124k	Film Resistor; 1%	0603	Yageo	RC0603FR-07124KL
1	U1	MPQ4560DQ	Step-Down Regulator	QFN10 (3mmx3mm)	MPS	MPQ4560DQ

## EVB TEST RESULTS

Performance waveforms are tested on the evaluation board.

$V_{IN} = 12V$ ,  $V_{OUT} = 5V$ ,  $T_A = 25^\circ C$ , unless otherwise noted.

**Output Ripple Voltage**

$I_{OUT} = 0.1A$

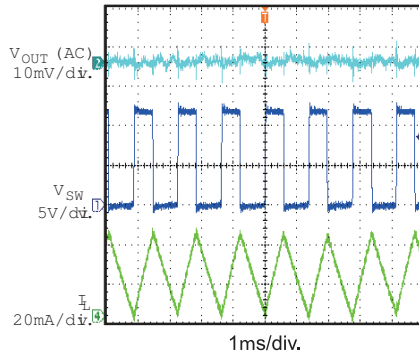

**Output Ripple Voltage**

$I_{OUT} = 2A$

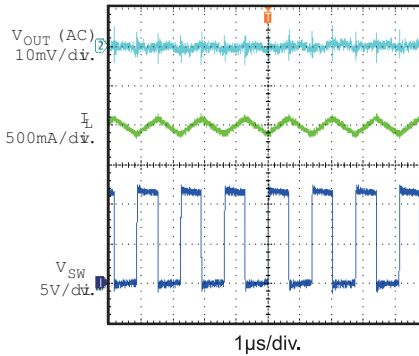

**Power On**

$I_{OUT} = 0A$

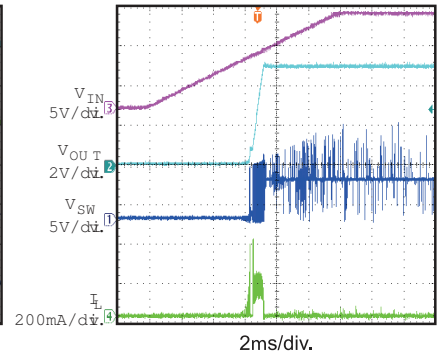

**Power On**

$I_{OUT} = 2A$

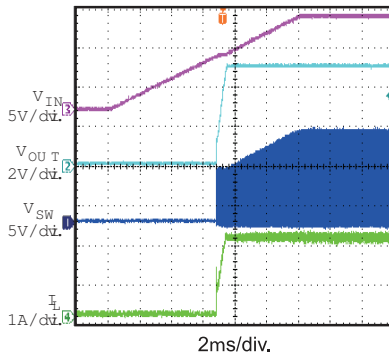

**Power Off**

$I_{OUT} = 0A$

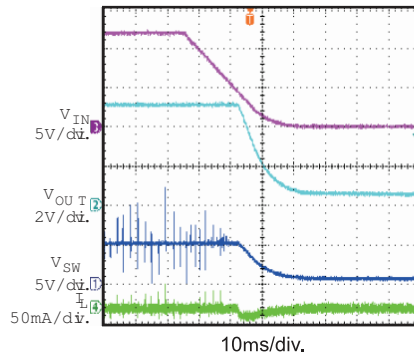

**Power Off**

$I_{OUT} = 2A$

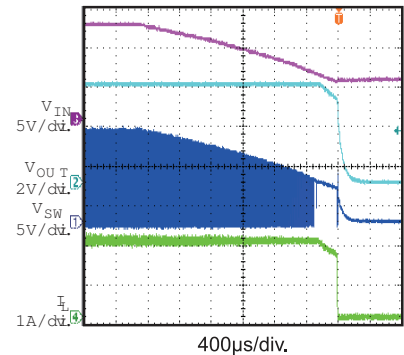

**En On**

$I_{OUT} = 0A$

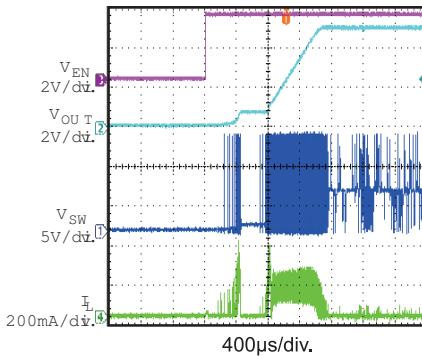

**En On**

$I_{OUT} = 2A$

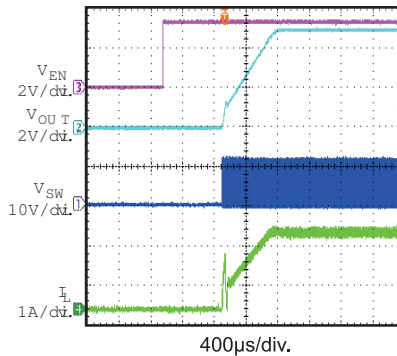

**En Off**

$I_{OUT} = 0A$

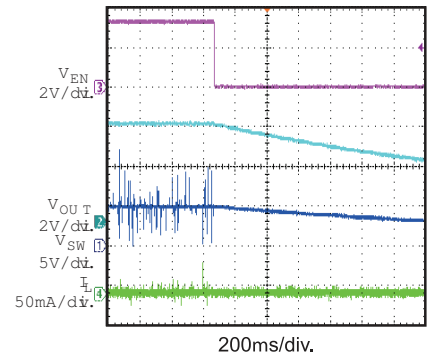

## EVB TEST RESULTS *(continued)*

Performance waveforms are tested on the evaluation board.

$V_{IN} = 12V$ ,  $V_{OUT} = 5V$ ,  $T_A = 25^\circ C$ , unless otherwise noted.

**En Off**

$I_{OUT} = 2A$

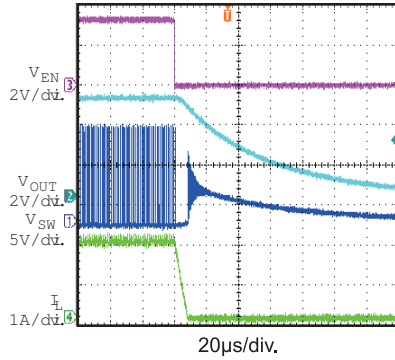

**Load Transient Response**

$I_{OUT} = 1A$  to  $2A$

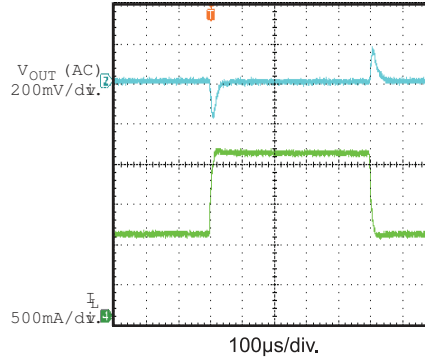

**Short Entry**

$I_{OUT} = 2A$

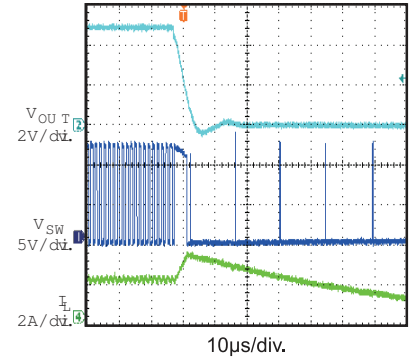

**Short Steady State**

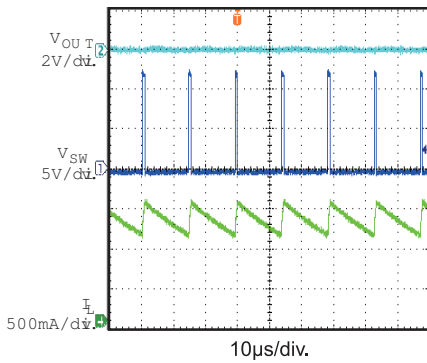

**Short Recovery**

$I_{OUT} = 2A$

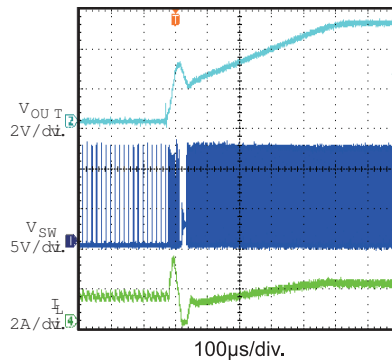

**Conducted EMI - QP**

$V_{IN}=24V$ ,  $I_{OUT}=2A$ , Resistor Load

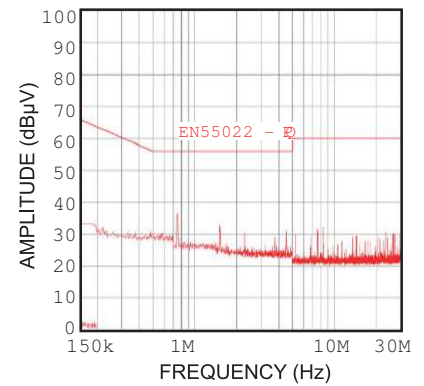

**Conducted EMI - AV**

$V_{IN}=24V$ ,  $I_{OUT}=2A$ , Resistor Load

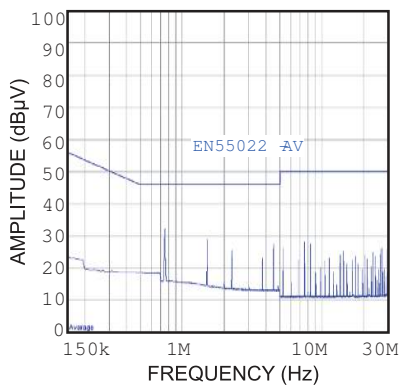

**Radiated EMI**

$V_{IN}=24V$ ,  $I_{OUT}=2A$ , Resistor Load

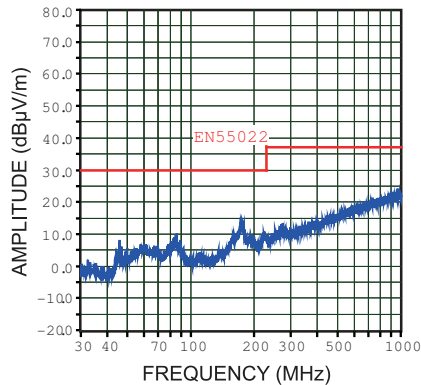

**PRINTED CIRCUIT BOARD LAYOUT**

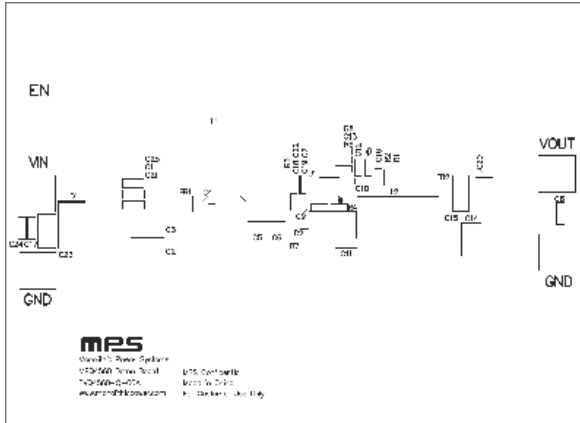

**Figure 1—Top Silk Layer**

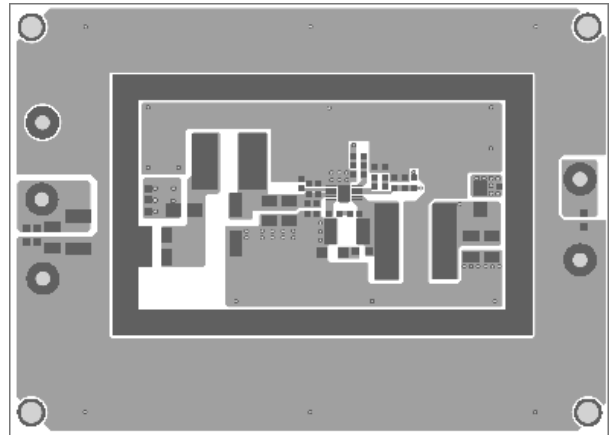

**Figure 2—Top Layer**

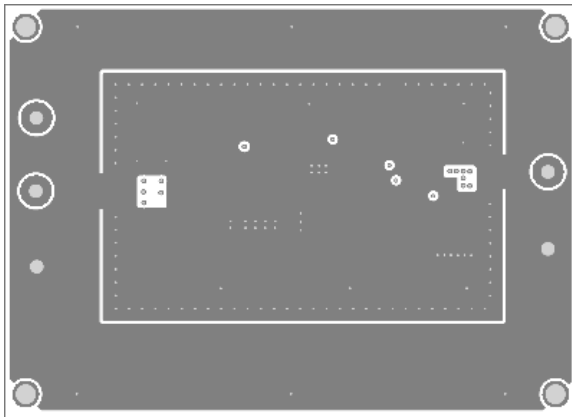

**Figure 1—Inner1 Layer**

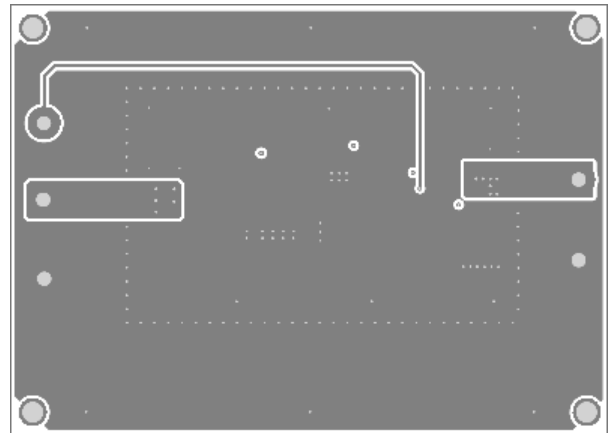

**Figure 2—Inner2 Layer**

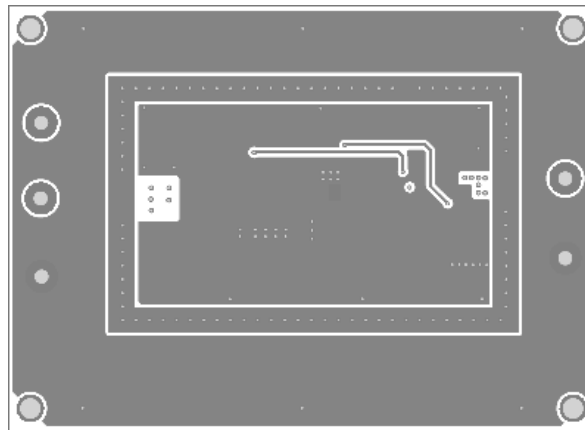

**Figure 3—Bottom Layer**

## QUICK START GUIDE

1. Connect the positive and negative terminals of the load to the VOUT and GND pins, respectively.
2. Preset the power supply output to between 8 and 55V, and then turn it off.
3. Connect the positive and negative terminals of the power supply output to the VIN and GND pins, respectively.
4. Turn the power supply on. The MPQ4560DQ will automatically startup.
5. To use the Enable function, apply a digital input to the EN pin. Drive EN higher than 1.55V to turn on the regulator, drive EN less than 1.23V to turn it off.
6. An input under voltage lockout (UVLO) function is implemented by the addition of a resistor divider R1 and R2. The EN threshold is 1.23V (falling edge), so  $V_{IN}$  UVLO threshold is  $1.23V \times \left(1 + \frac{R1}{R2}\right)$ . It is preset to around 3.8V on this board.
7. Use R6 and R8 to set the output voltage with  $V_{FB} = 0.8V$ . For  $R6 = 23.7k\Omega$ , R8 can be determined by:  $R8 = 29.625 \times (V_{OUT} - 0.8)$  (k $\Omega$ ). Follow the Application Information section in the device datasheet to recalculate the compensation, inductor and output capacitor values when output voltage is changed.

**NOTICE:** The information in this document is subject to change without notice. Users should warrant and guarantee that third party Intellectual Property rights are not infringed upon when integrating MPS products into any application. MPS will not assume any legal responsibility for any said applications.