

ENCLOSURE ASSEMBLY TOP VIEW

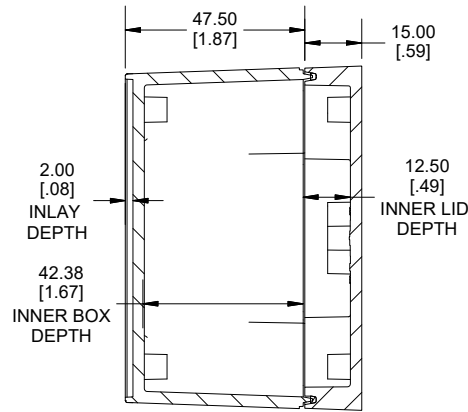

**SECTION A-A
END VIEW**

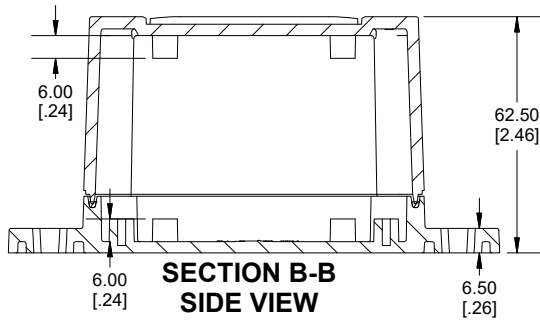

**SECTION B-B
SIDE VIEW**

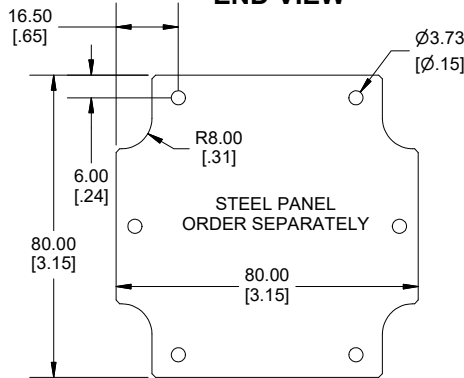

**STEEL PANEL
ORDER SEPARATELY**

POLYCARBONATE
VERSION ONLY



Enclosures can be Factory Modified (Milling, Drilling, Printing etc.)
Contact Factory (modshop@hammfg.com) for quotes
Solid models of this enclosure available in .stp or .x_t
(Part number and text placement/orientation on our products are subject to change,
we do not recommend using them as a locating reference for modification purposes)

NOTE
Purchased assembly includes styled box, flanged lid, 4 cover screws, and preformed silicone gasket.
General Purpose ABS version is not UL approved. (Matl UL94 - HB)
Polycarbonate version is UL 508 approved. (Matl UL94 - 5VA @ 3mm)
Recommended Cover screw torque -- 2.5 lbf-in (30 cN-m)

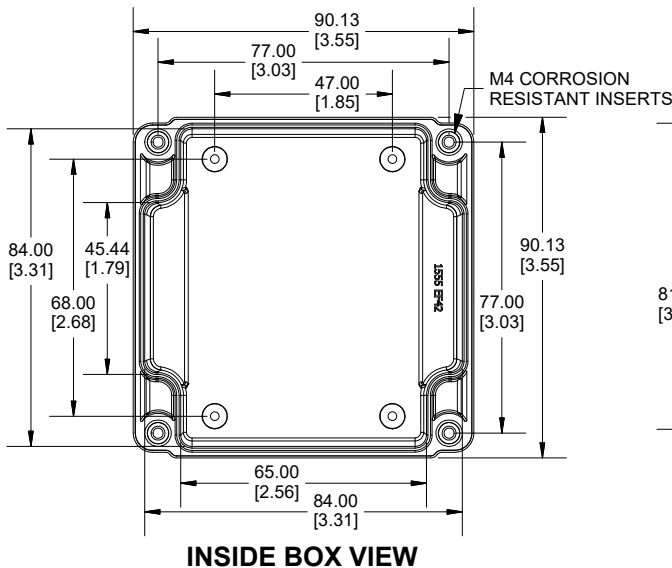

INSIDE BOX VIEW

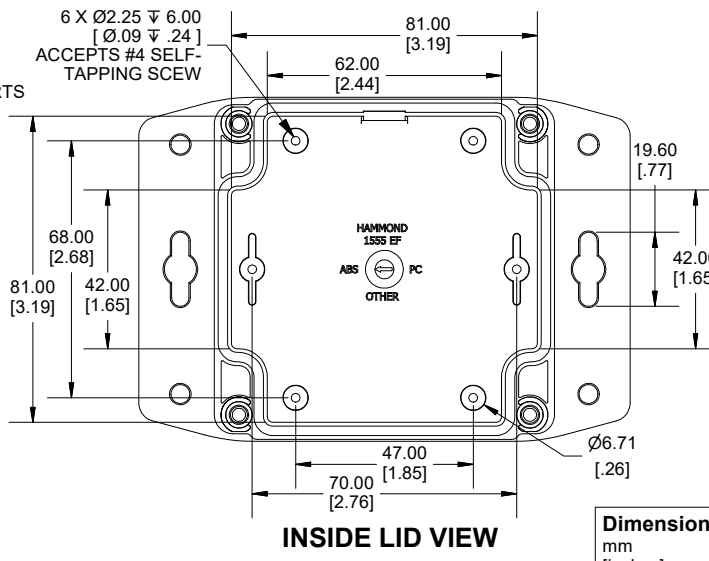

INSIDE LID VIEW

Dimensions:
mm
[inches]

1555EF	
1555EF Regular Enclosure	
General Purpose ABS RAL-7035	1555EF42GY
Polycarbonate RAL-7035	1555E2F42GY
ACCESSORIES	
Steel Inner Panels	1555EFPL
Silicone Pre-formed Gasket Black	1554EGASKET
Steel Panel / P.C. Board Self Tapping Screw [#4 X 1/4" (6.4mm) Plated]	1555TS100
Stainless Steel Cover Screws [M4-0.7 X 20mm] (Pkg 50)	SC576-50

**HAMMOND
MANUFACTURING®**
1555EF42
www.hammondmfg.com