

XS1M18PAS20

Inductive proximity sensors XS, inductive sensor XS1 M18, L60mm, stainless, Sn5mm, 12...24 VDC, cable 2 m



Main

Range of Product	Telemecanique Inductive proximity sensors XS
Series name	Application
Sensor Type	Inductive proximity sensor
Device Application	Selective detection of non ferrous materials
Sensor name	XS1
Sensor design	Cylindrical M18
Size	60 mm
Body type	Fixed
Detector flush mounting acceptance	Flush mountable
Material	Stainless steel
Type of output signal	Discrete
Wiring Technique	3-wire
[Sn] nominal sensing distance	0.20 in (5 mm)
Discrete output function	1 NO
Output circuit type	DC
Discrete output type	PNP
Electrical connection	Cable
Cable length	6.56 ft (2 m)
[Us] rated supply voltage	12...24 V DC reverse polarity protection
Switching capacity in mA	<= 200 mA overload and short-circuit protection
IP degree of protection	IP68 conforming to IEC 60529

Complementary

Thread type	M18 x 1
Detection face	Frontal
Front material	PPS
Enclosure Material	Stainless steel : 304 CU
Operating zone	0.00...0.16 in (0...4 mm)
Cable composition	3 x 0.34 mm ²
Wire insulation material	PvR
Status LED	Output state 1 LED yellow)
Supply voltage limits	10...38 V DC
Switching frequency	<= 1000 Hz
Maximum voltage drop	<2.6 V closed)
Current consumption	0...15 mA no-load
Maximum delay first up	10 ms
Maximum delay response	0.3 ms
Maximum delay recovery	0.7 ms
Marking	CE
Threaded length	2.05 in (52 mm)
Height	0.71 in (18 mm)

Length	2.36 in (60 mm)
Net Weight	0.26 lb(US) (0.12 kg)

Environment

Product Certifications	CSA UL
Ambient Air Temperature for Operation	-13...158 °F (-25...70 °C)





Ordering and shipping details

Category	22486-SENSORS, PROXIMITY
Discount Schedule	DS2
GTIN	3389110873849
Nbr. of units in pkg.	1
Package weight(Lbs)	4.55 oz (129.0 g)
Returnability	No
Country of origin	FR

Packing Units

Unit Type of Package 1	PCE
Package 1 Height	1.77 in (4.5 cm)
Package 1 width	3.23 in (8.2 cm)
Package 1 Length	5.20 in (13.2 cm)
Unit Type of Package 2	BAG
Number of Units in Package 2	1
Package 2 Weight	4.55 oz (129.0 g)
Package 2 Height	1.18 in (3 cm)
Package 2 width	7.87 in (20 cm)
Package 2 Length	5.91 in (15 cm)
Unit Type of Package 3	S01
Number of Units in Package 3	12
Package 3 Weight	3.91 lb(US) (1.773 kg)
Package 3 Height	5.91 in (15 cm)
Package 3 width	5.91 in (15 cm)
Package 3 Length	15.75 in (40 cm)

Offer Sustainability

Sustainable offer status	Green Premium product
California proposition 65	WARNING: This product can expose you to chemicals including: Diisononyl phthalate (DINP), which is known to the State of California to cause cancer, and Di-isodecyl phthalate (DIDP), which is known to the State of California to cause birth defects or other reproductive harm. For more information go to www.P65Warnings.ca.gov
REACH Regulation	 REACH Declaration
EU RoHS Directive	Pro-active compliance (Product out of EU RoHS legal scope)  EU RoHS Declaration
Mercury free	Yes
RoHS exemption information	 Yes
Environmental Disclosure	 Product Environmental Profile
Circularity Profile	 End Of Life Information

Contractual warranty

Warranty	18 months
----------	-----------

Dimensions

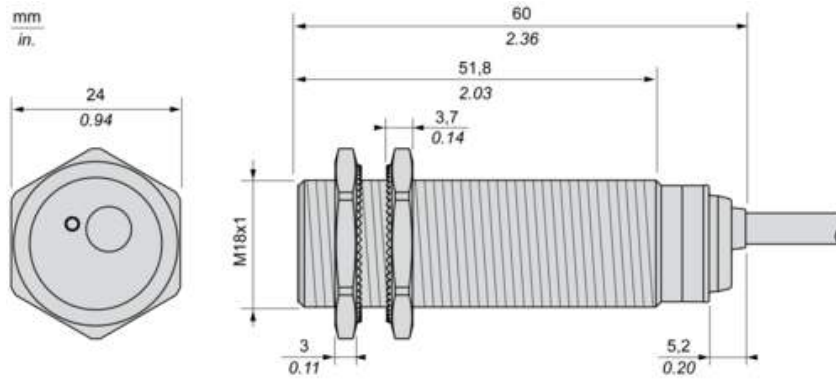

Minimum Mounting Distances

Side by side



$e (1) \geq 10 \text{ mm}/0.39 \text{ in.}$

Face to face

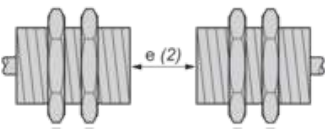

$e (2) \geq 60 \text{ mm}/2.36 \text{ in.}$

Facing a metal object



$e (3) \geq 15 \text{ mm}/0.60 \text{ in.}$

Mounting

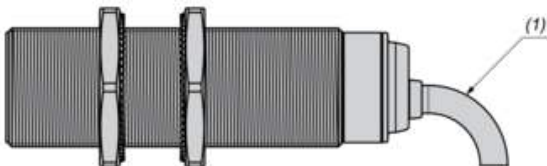

(1) Bending cable: 4 x external cable diameter

Wiring Schemes

PNP

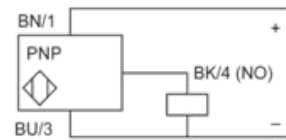

BU : Blue

BN : Brown

BK : Black

Performance Curves

Standard Steel Target : 18x18x1 mm

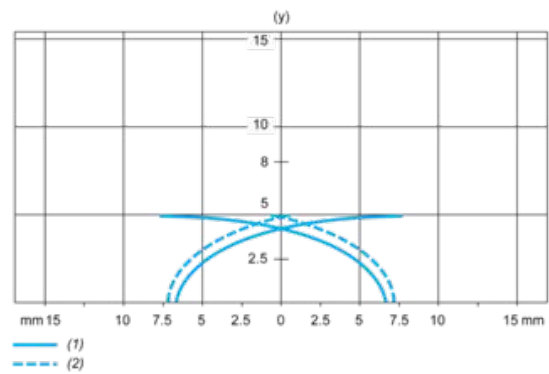

(1) Pick-up points

(2) Drop-out points (object approaching from the side)

(y) Sensing distance in mm