

54F/74F2244

Octal Buffer/Line Driver with 25Ω Series Resistors in Outputs

General Description

The 'F2244 is an octal buffer/line driver designed to drive the capacitive inputs of MOS memory drivers, address drivers, clock drivers and bus-oriented transmitters/receivers.

The 25Ω series resistors in the outputs reduce ringing and eliminate the need for external resistors.

Features

- TRI-STATE® outputs drive bus lines or buffer memory address registers
- 12 mA source current
- 25Ω series resistors in outputs eliminate the need for external resistors.
- Designed to drive the capacitive inputs of MOS devices
- Guaranteed 4000V minimum ESD protection

Commercial	Military	Package Number	Package Description
74F2244PC		N20B	20-Lead (0.300" Wide) Molded Dual-In-Line
	54F2244DM (Note 2)	J20A	20-Lead Ceramic Dual-In-Line
74F2244SC (Note 1)		M20B	20-Lead (0.300" Wide) Molded Small Outline JEDEC
74F2244MSA (Note 1)		MSA20	20-Lead Molded Shrink Small Outline EIAJ Type II
	54F2244FM (Note 2)	W20A	20-Lead Cerpak
	54F2244LM (Note 2)	E20A	20-Lead Ceramic Leadless Chip Carrier, Type C

Note 1: Devices also available in 13" reel. Use suffix = SCX and MSAX.

Note 2: Military grade device with environmental and burn-in processing. Use suffix = DMQB, FMQB and LMQB.

Connection Diagrams

Pin Assignment for LCC

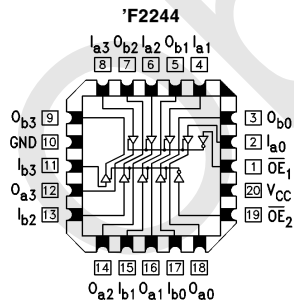

TL/F/9499-3

Pin Assignment for DIP, SOIC and SSOP

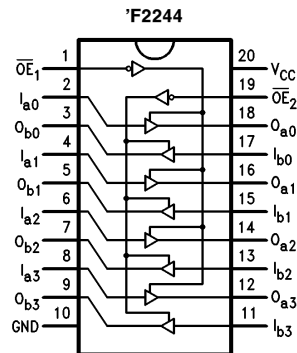

TL/F/9499-4

TRI-STATE® is a registered trademark of National Semiconductor Corporation.

Logic Symbol

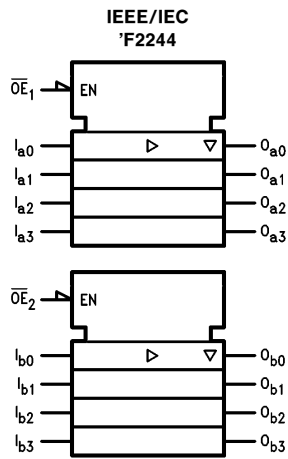

TL/F/9499-6

Unit Loading/Fan Out

Pin Names	Description	54F/74F	
		U.L. HIGH/LOW	Input I_{IH}/I_{IL} Output I_{OH}/I_{OL}
$\overline{OE}_1, \overline{OE}_2$	TRI-STATE Output Enable Input (Active LOW)	1.0/1.667	20 μA / -1 mA
OE_2	TRI-STATE Output Enable Input (Active HIGH)	1.0/1.667	20 μA / -1 mA
I_{an}, I_{bn}	Inputs	1.0/2.667*	20 μA / -1.6 mA
O_{an}, O_{bn}	Outputs	750/20	-15 mA / 12 mA

*Worst-case 'F2244 disabled

Truth Table

'F2244

\overline{OE}_1	I_{an}	O_{an}	\overline{OE}_2	I_{bn}	O_{bn}
H	X	Z	H	X	Z
L	H	H	L	H	H
L	L	L	L	L	L

H = HIGH Voltage Level
L = LOW Voltage Level
X = Immaterial
Z = High Impedance

Absolute Maximum Ratings (Note 1)

If Military/Aerospace specified devices are required, please contact the National Semiconductor Sales Office/Distributors for availability and specifications.

Storage Temperature	-65°C to +150°C
Ambient Temperature under Bias	-55°C to +125°C
Junction Temperature under Bias	-55°C to +175°C
Plastic	-55°C to +150°C
V _{CC} Pin Potential to Ground Pin	-0.5V to +7.0V
Input Voltage (Note 2)	-0.5V to +7.0V
Input Current (Note 2)	-30 mA to +5.0 mA
Voltage Applied to Output in HIGH State (with V _{CC} = 0V)	
Standard Output	-0.5V to V _{CC}
TRI-STATE Output	-0.5V to +5.5V

Current Applied to Output in LOW State (Max) twice the rated I_{OL} (mA)

ESD Last Passing Voltage (Min) 4000V

Note 1: Absolute maximum ratings are values beyond which the device may be damaged or have its useful life impaired. Functional operation under these conditions is not implied.

Note 2: Either voltage limit or current limit is sufficient to protect inputs.

Recommended Operating Conditions

Free Air Ambient Temperature	
Military	-55°C to +125°C
Commercial	0°C to +70°C
Supply Voltage	
Military	+4.5V to +5.5V
Commercial	+4.5V to +5.5V

DC Electrical Characteristics

Symbol	Parameter	54F/74F			Units	V _{CC}	Conditions
		Min	Typ	Max			
V _{IH}	Input HIGH Voltage	2.0			V		Recognized as a HIGH Signal
V _{IL}	Input LOW Voltage			0.8	V		Recognized as a LOW Signal
V _{CD}	Input Clamp Diode Voltage			-1.2	V	Min	I _{IN} = -18 mA
V _{OH}	Output HIGH Voltage	54F 10% V _{CC} 54F 10% V _{CC} 74F 10% V _{CC} 74F 10% V _{CC} 74F 5% V _{CC}	2.4 2.0 2.4 2.0 2.7		V	Min	I _{OH} = -3 mA I _{OH} = -12 mA I _{OH} = -3 mA I _{OH} = -15 mA I _{OH} = -3 mA
V _{OL}	Output LOW Voltage			0.50 0.75	V	Min	I _{OL} = 1 mA I _{OL} = 12 mA
I _{IH}	Input HIGH Current	54F 74F		20.0 5.0	μA	Max	V _{IN} = 2.7V
I _{BVI}	Input HIGH Current Breakdown Test	54F 74F		100 7.0	μA	Max	V _{IN} = 7.0V
I _{CEX}	Output HIGH Leakage Current	54F 74F		250 50	μA	Max	V _{OUT} = V _{CC}
V _{ID}	Input Leakage Test	74F	4.75		V	0.0	I _{ID} = 1.9 μA All other pins grounded
I _{OD}	Output Leakage Circuit Current	74F		3.75	μA	0.0	V _{IOD} = 150 mV All other pins grounded
I _{IL}	Input LOW Current			-1.0 -1.6	mA	Max	V _{IN} = 0.5V ($\overline{OE}_1, \overline{OE}_2, OE_2$) V _{IN} = 0.5V (I _n)
I _{OZH}	Output Leakage Current			50	μA	Max	V _{OUT} = 2.7V
I _{OZL}	Output Leakage Current			-50	μA	Max	V _{OUT} = 0.5V
I _{OS}	Output Short-Circuit Current			-100 -225	mA	Max	V _{OUT} = 0V
I _{CCH}	Power Supply Current		40	60	mA	Max	V _O = HIGH
I _{CCL}	Power Supply Current		60	90	mA	Max	V _O = LOW
I _{CCZ}	Power Supply Current		60	90	mA	Max	V _O = HIGH Z

AC Electrical Characteristics

Symbol	Parameter	74F			54F		74F		Units
		T _A = +25°C V _{CC} = +5.0V C _L = 50 pF			T _A , V _{CC} = Mil C _L = 50 pF		T _A , V _{CC} = Com C _L = 50 pF		
		Min	Typ	Max	Min	Max	Min	Max	
t _{PLH}	Propagation Delay	1.5		7.0	2.0	6.5	1.5	7.0	ns
t _{PHL}	Data to Output	2.5		8.0	2.0	7.0	2.0	8.0	
t _{PZH}	Output Enable Time	1.5		9.0	2.0	7.0	1.0	9.5	ns
t _{PZL}		2.5		11.5	2.0	8.5	2.5	12.0	
t _{PHZ}	Output Disable Time	1.5		9.0	2.0	7.0	1.0	9.5	ns
t _{PLZ}		1.5		8.5	2.0	7.5	1.5	9.5	

Ordering Information

The device number is used to form part of a simplified purchasing code where a package type and temperature range are defined as follows:

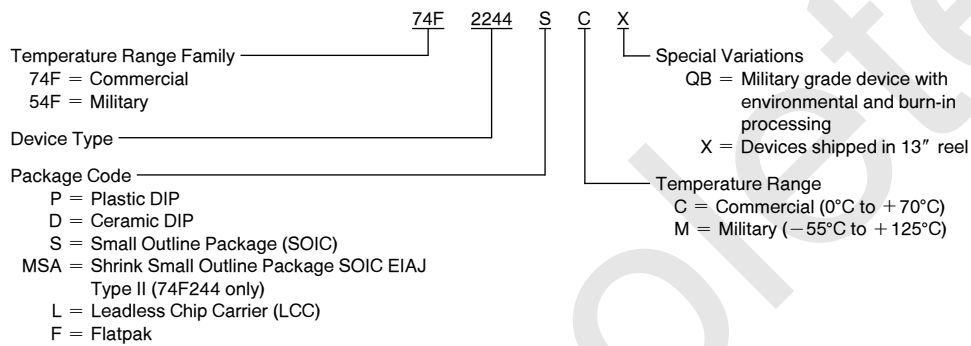

Obsolete

Physical Dimensions inches (millimeters)

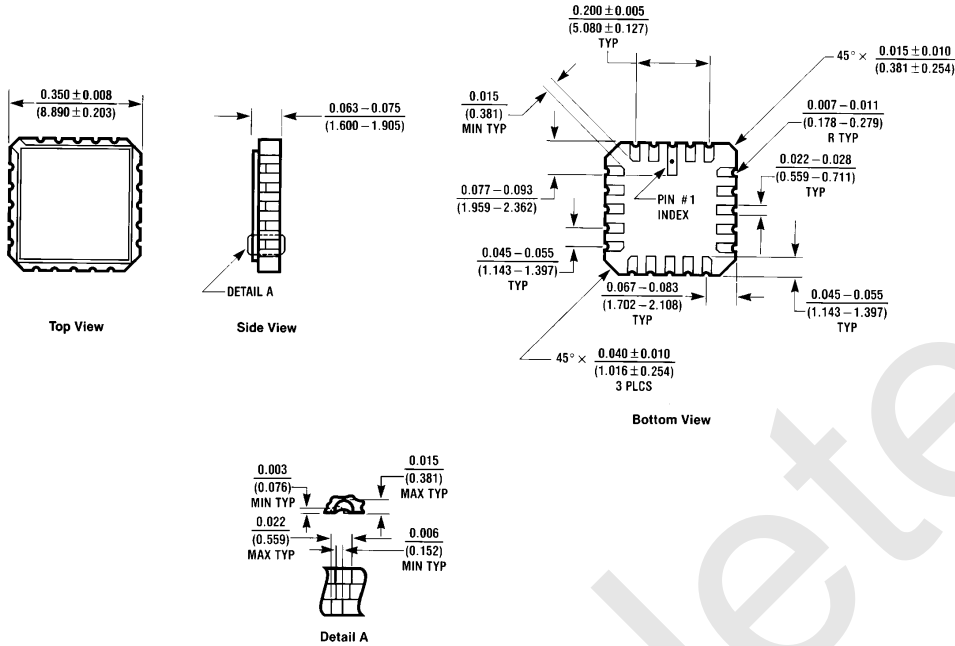

20-Lead Ceramic Leadless Chip Carrier, Type C (L)
NS Package Number E20A

E20A (REV D)

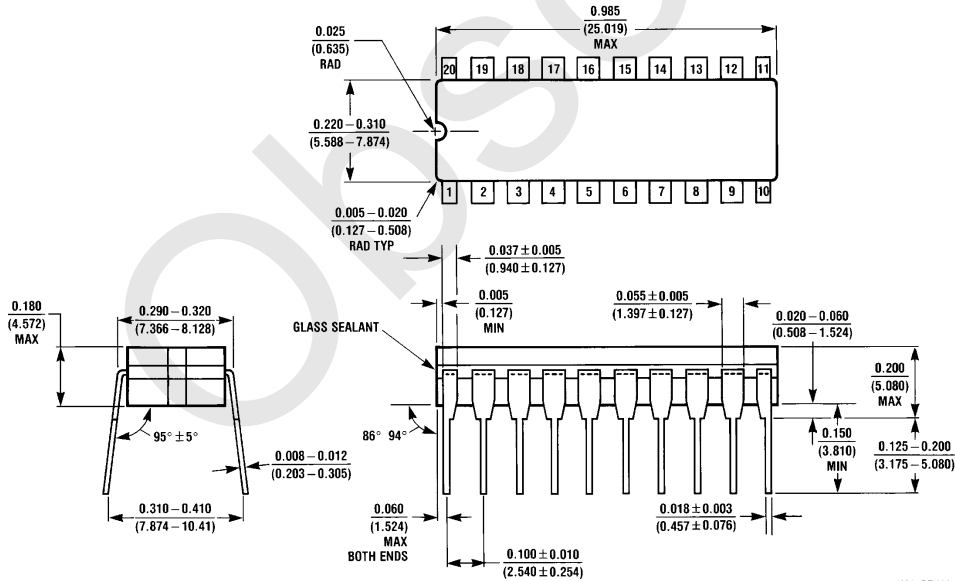

20-Lead Ceramic Dual-In-Line Package (D)
NS Package Number J20A

J20A (REV M)

Physical Dimensions inches (millimeters) (Continued)

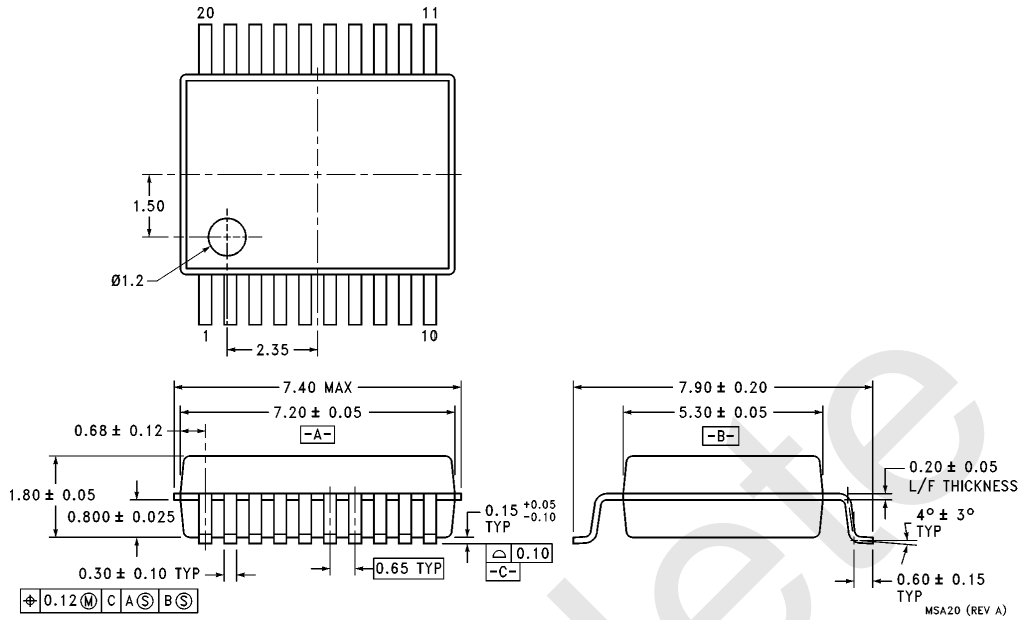

20-Lead Molded Shrink Small Outline Package, EIAJ Type II (MSA)
NS Package Number MSA20

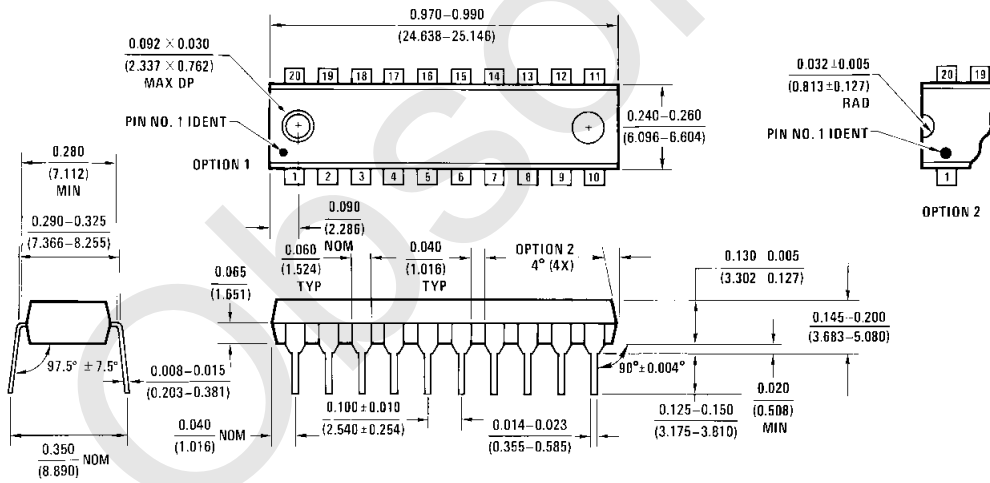

20-Lead (0.300" Wide) Molded Dual-In-Line Package (P)
NS Package Number N20B

Physical Dimensions inches (millimeters) (Continued)

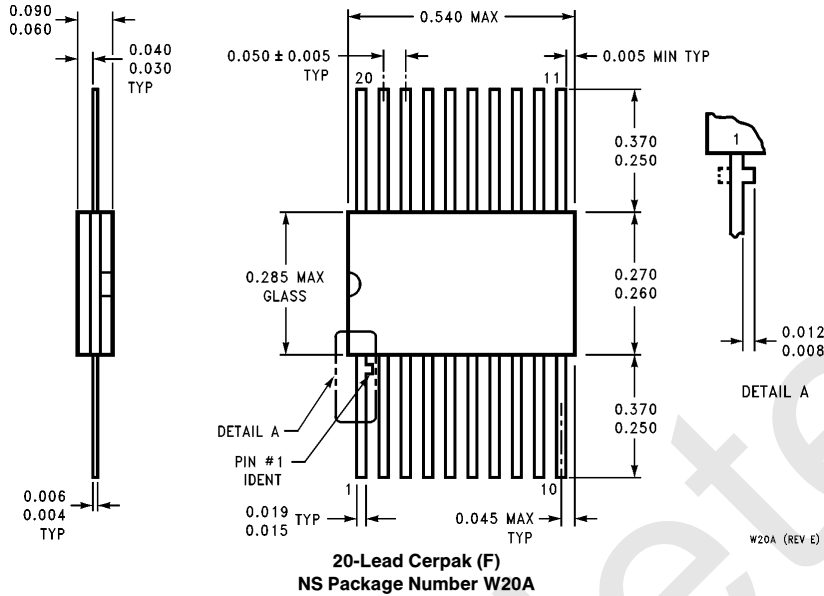

LIFE SUPPORT POLICY

NATIONAL'S PRODUCTS ARE NOT AUTHORIZED FOR USE AS CRITICAL COMPONENTS IN LIFE SUPPORT DEVICES OR SYSTEMS WITHOUT THE EXPRESS WRITTEN APPROVAL OF THE PRESIDENT OF NATIONAL SEMICONDUCTOR CORPORATION. As used herein:

1. Life support devices or systems are devices or systems which, (a) are intended for surgical implant into the body, or (b) support or sustain life, and whose failure to perform, when properly used in accordance with instructions for use provided in the labeling, can be reasonably expected to result in a significant injury to the user.
2. A critical component is any component of a life support device or system whose failure to perform can be reasonably expected to cause the failure of the life support device or system, or to affect its safety or effectiveness.



National Semiconductor Corporation
1111 West Bardin Road
Arlington, TX 76017
Tel: 1(800) 272-9959
Fax: 1(800) 737-7018

National Semiconductor Europe
Fax: (+49) 0-180-530 85 86
Email: cnjwge@tevm2.nsc.com
Deutsch Tel: (+49) 0-180-530 85 85
English Tel: (+49) 0-180-532 78 32
Français Tel: (+49) 0-180-532 93 58
Italiano Tel: (+49) 0-180-534 16 80

National Semiconductor Hong Kong Ltd.
19th Floor, Straight Block,
Ocean Centre, 5 Canton Rd.
Tsimshatsui, Kowloon
Hong Kong
Tel: (852) 2737-1600
Fax: (852) 2736-9960

National Semiconductor Japan Ltd.
Tel: 81-043-299-2309
Fax: 81-043-299-2408

National does not assume any responsibility for use of any circuitry described, no circuit patent licenses are implied and National reserves the right at any time without notice to change said circuitry and specifications.