

REVISIONS					
REV	ECO	DESCRIPTION	DATE	BY	APPR
A3	-	RELEASE NEW DRAWING FORMAT	11DEC13	DRP	-

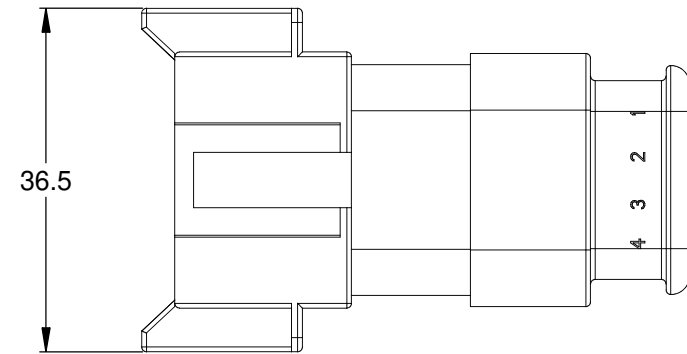

36.5

REQUIRES CONTACT RETENTION WEDGE AW8P

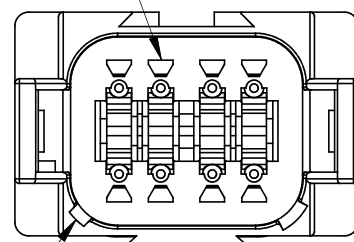

1 KEYWAY (2) PLACES

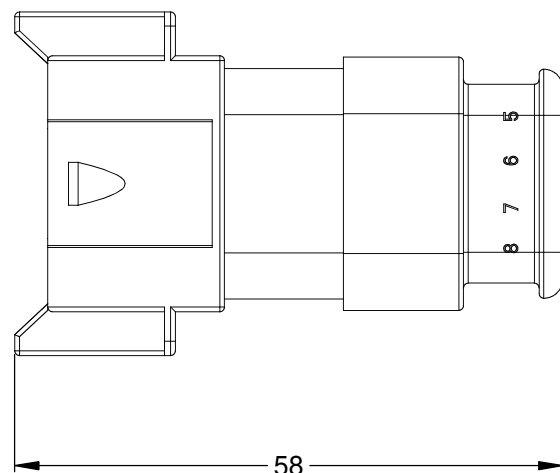
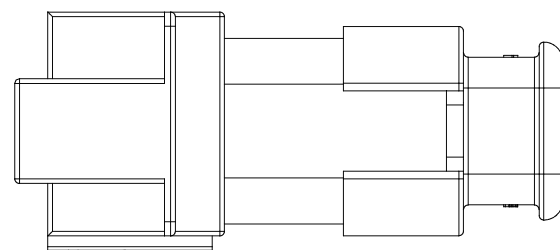

58

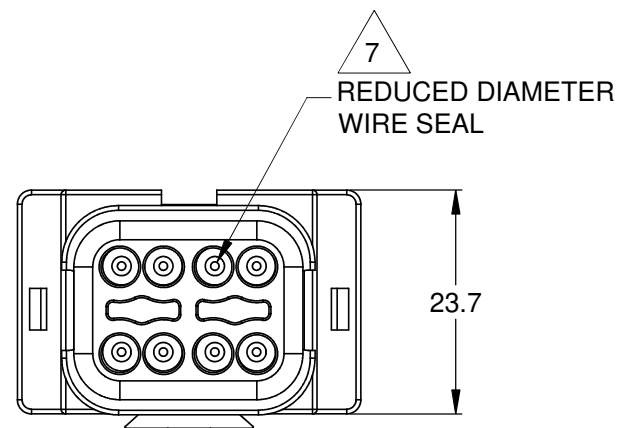

7 REDUCED DIAMETER WIRE SEAL

23.7

STRAIN RELIEF END CAP - BLACK - ALL CONNECTORS

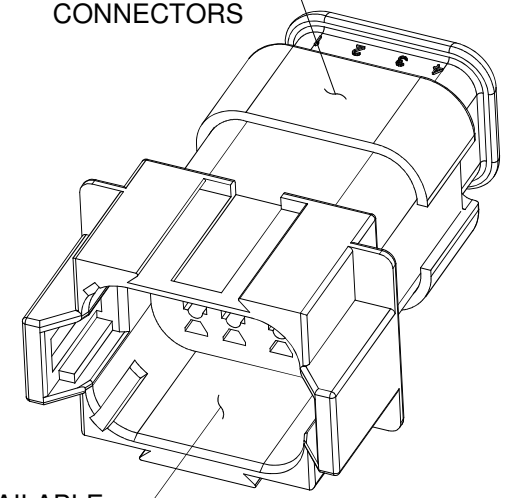

1 REFER TO SHEET 2 FOR AVAILABLE CONNECTOR HOUSING COLORS

NOTES: UNLESS OTHERWISE SPECIFIED

1 SEE SHEET 2 FOR KEY ARRANGEMENTS AND COLORS.

2. MATERIAL:
HOUSING: THERMOPLASTIC
SEAL: SILICONE RUBBER

3. MODIFICATIONS: STRAIN RELIEF END CAP;
REDUCED DIA. WIRE SEAL

4. SPECIFICATIONS:
4.1 CURRENT RATING: 13 AMPS
4.2 OPERATING TEMPERATURE: -55°C TO +125°C
4.3 DIELECTRIC WITHSTANDING VOLTAGE: LESS THAN 2 MILLIAMPS CURRENT LEAKAGE @ 1500 VOLTS AC.
4.4 INSULATION RESISTANCE: 1000 MEGOHMS MIN @ 25°C.
4.5 MOISTURE RESISTANCE: IP67 (MATED CONDITION)
4.6 MATING CYCLE DURABILITY: 100 CYCLES
4.7 RoHS COMPLIANT

5. MATING PART: AT06-08SX* PLUG
(X = A,B,C,D KEYS; * = MODIFICATIONS AND COLORS)

6. ALL DIMENSIONS ARE FOR REFERENCE USE ONLY.

7 CONTACT SIZE AND REAR SEAL WIRE RANGE:

CONTACT SIZE	MIN. INSUL O.D.	MAX. INSUL O.D.	TYPICAL WIRE RANGE
16	1.35 mm (.053 in)	3.05 mm (.120 in)	14 - 20 AWG

QUANTITY	SEE SHEET 2 PART NUMBER	DESCRIPTION	ITEM
MATERIALS LIST			
UNLESS OTHERWISE SPECIFIED 1) All dimensions are in metric(mm). 2) Tolerances are as follows: 1 PL DEC ±0.30 2 PL DEC ±0.15 3 PL DEC ±0.08 Fractions ±1/64 Angles ±1° 3) Note reference = X		SIGNATURES DRAWN: D.PARKS CHECKED: ENGINEER: APPROVAL:	DATE 11DEC13
MATERIAL SPECIFICATIONS:		<p style="text-align: center;">Amphenol</p> <p style="text-align: center;">Sine Systems - www.amphenol-sine.com 44724 Morley Drive Clinton Township, MI 48036</p>	
PROCESS SPECIFICATIONS:			
NEXT ASSY:		CUSTOMER: THIS DRAWING IS SUPPLIED FOR INFORMATION ONLY. DESIGN FEATURES, SPECIFICATIONS AND PERFORMANCE DATA SHOWN HEREON ARE THE PROPERTY OF THE AMPHENOL CORPORATION. NO RIGHTS OF REPRODUCTION ARE IMPLIED. ALL DIMENSIONS ARE SUBJECT TO NORMAL MANUFACTURING VARIATIONS.	<p style="text-align: center;">RECEPTACLE, 8 PIN, AT SERIES, KEYED, STRAIN RELIEF END CAP, REDUCED DIAMETER SEAL</p>
		<p>SIZE: B C- DWG NO: AT04-08PX-SR2XX REVISION: A3</p> <p>SCALE: NONE SHEET 1 OF 2</p>	

TITLE: RECEPTACLE, 8 PIN, AT SERIES, KEYED, STRAIN RELIEF, REDUCED DIA SEAL

DWG NO: AT04-08PX-SR2XX

REV: A3

SH: 1

OF: 2

REVISIONS					
REV	ECO	DESCRIPTION	DATE	BY	APPR

P/N AT04-08PA-SR2GY
KEY-A CONFIGURATION
STANDARD COLOR: GREY

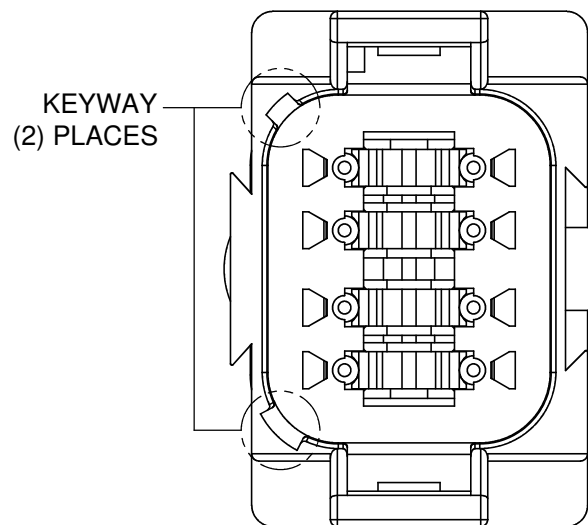

P/N AT04-08PB-SR2BK
KEY-B CONFIGURATION
STANDARD COLOR: BLACK

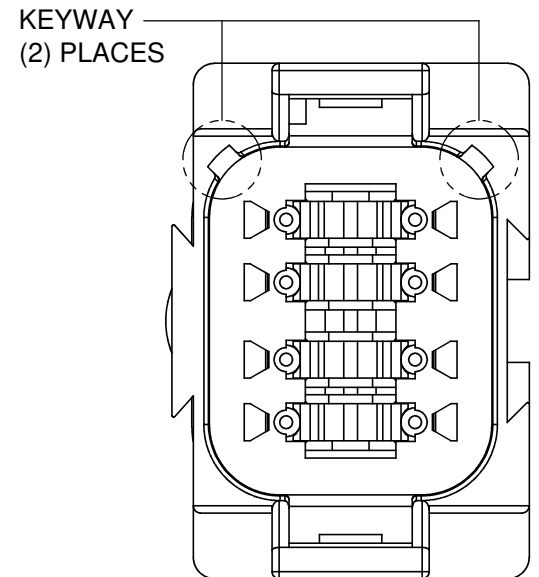

P/N AT04-08PC-SR2GN
KEY-C CONFIGURATION
STANDARD COLOR: GREEN

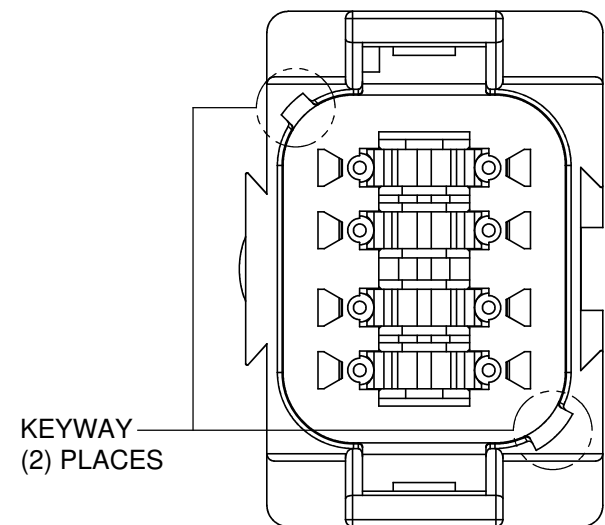

P/N AT04-08PD-SR2BR
KEY-D CONFIGURATION
STANDARD COLOR: BROWN

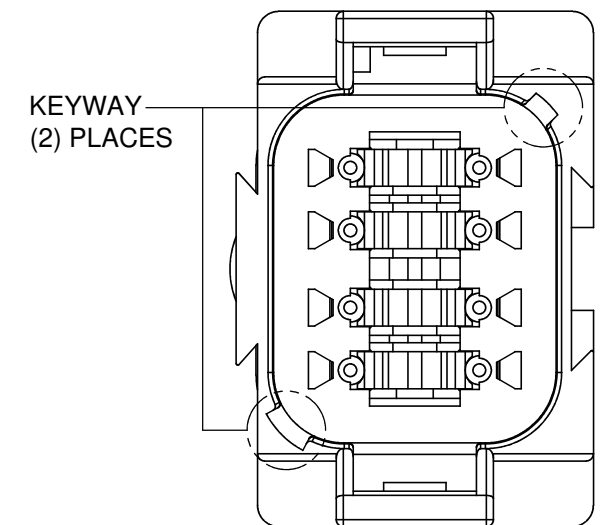

KEY-A CONFIGURATION	
COLOR	PART NUMBER
* GREY	AT04-08PA-SR2GY
BLACK	AT04-08PA-SR2BK
GREEN	AT04-08PA-SR2GN
BROWN	AT04-08PA-SR2BR

KEY-B CONFIGURATION	
COLOR	PART NUMBER
GREY	AT04-08PB-SR2GY
* BLACK	AT04-08PB-SR2BK
GREEN	AT04-08PB-SR2GN
BROWN	AT04-08PB-SR2BR

KEY-C CONFIGURATION	
COLOR	PART NUMBER
GREY	AT04-08PC-SR2GY
BLACK	AT04-08PC-SR2BK
* GREEN	AT04-08PC-SR2GN
BROWN	AT04-08PC-SR2BR

KEY-D CONFIGURATION	
COLOR	PART NUMBER
GREY	AT04-08PD-SR2GY
BLACK	AT04-08PD-SR2BK
GREEN	AT04-08PD-SR2GN
* BROWN	AT04-08PD-SR2BR

NOTE:

AN ASTERISKS (*) PLACED BEFORE THE COLOR DENOTES THE STANDARD MOLDED COLOR OF THE CONNECTORS SHOWN ABOVE. STRAIN RELIEF END CAPS ARE AVAILABLE IN BLACK ONLY.



OTHER COLORS SHOWN ARE AVAILABLE VIA SPECIAL ORDER.



TITLE: RECEPTACLE, 8 PIN, AT SERIES, KEYED, STRAIN RELIEF, REDUCED DIA SEAL
DWG NO: AT04-08PX-SR2XX
REV: A3
SH: 2
OF: 2

QUANTITY	PART NUMBER	DESCRIPTION	ITEM
MATERIALS LIST			
UNLESS OTHERWISE SPECIFIED 1) All dimensions are in metric(mm). 2) Tolerances are as follows: 1 PL DEC ±0.30 2 PL DEC ±0.15 3 PL DEC ±0.08 Fractions ±1/64 Angles ±1° 3) Note reference =		SIGNATURES DRAWN: D.PARKS CHECKED: ENGINEER: APPROVAL:	DATE 11DEC13
MATERIAL SPECIFICATIONS:		<div style="text-align: center;"> <h1>Amphenol</h1> <p>Sine Systems - www.amphenol-sine.com 44724 Morley Drive Clinton Township, MI 48036</p> </div>	
PROCESS SPECIFICATIONS:			
NEXT ASSY:		THIS DRAWING IS SUPPLIED FOR INFORMATION ONLY. DESIGN FEATURES, SPECIFICATIONS AND PERFORMANCE DATA SHOWN HEREON ARE THE PROPERTY OF THE AMPHENOL CORPORATION. NO RIGHTS OF REPRODUCTION ARE IMPLIED. ALL DIMENSIONS ARE SUBJECT TO NORMAL MANUFACTURING VARIATIONS.	
		SIZE: B C- SCALE: NONE	DWG NO: AT04-08PX-SR2XX REVISION: A3 SHEET 2 OF 2



AT Series™ - Contact Size 16 Options

Machined Contacts, Sockets & Pins				
Part Number	Description	Size	AWG	Type
AT60-215-1631	Male Contact - Pin, Gold-plated	16	14	Machined
AT62-209-1631	Female Contact - Socket, Gold-plated	16	14	Machined
AT60-215-16141	Male Contact - Pin, Nickel-plated	16	14	Machined
AT62-209-16141	Female Contact - Socket, Nickel-plated	16	14	Machined
AT60-202-1631	Male Contact - Pin, Gold-plated	16	16-20	Machined
AT62-201-1631	Female Contact - Socket, Gold-plated	16	16-20	Machined
AT60-202-16141	Male Contact - Pin, Nickel-plated	16	16-20	Machined
AT62-201-16141	Female Contact - Socket, Nickel-plated	16	16-20	Machined
AT60-202-1631-22	Male Contact - Pin, Gold-plated	16	22-24	Machined
AT62-201-1631-22	Female Contact - Socket, Gold-plated	16	22-24	Machined
AT60-202-16141-22	Male Contact - Pin, Nickel-plated	16	22-24	Machined
AT62-201-16141-22	Female Contact - Socket, Nickel-plated	16	22-24	Machined

Tooling - Machined Contacts		
Part	Part Number	Description
	CA-5D12	Universal Hand Crimp Tool, Size 12/16/20 (Machined contacts only)
	CA-5E12	Pneumatic Crimp Tool, Size 12/16/20 (Machined contacts only)

Contact Removal Tools		
Part	Part Number	Description
	ATRT-100	Used for removal of contacts for A Series™ products
	AT11-310-1605	Contact Removal Tool, Plastic, Size 16
	A114017	Sealing Plug, Size 16, White

Stamped & Formed Contacts, Sockets & Pins				
Part Number	Description	Size	AWG	Type
AT60-14-0144	Male Contact - Pin, Gold-plated	16	14-16	Stamped & Formed
AT62-14-0144	Female Contact - Socket, Gold-plated	16	14-16	Stamped & Formed
AT60-14-0122	Male Contact - Pin, Nickel-plated	16	14-16	Stamped & Formed
AT62-14-0122	Female Contact - Socket, Nickel-plated	16	14-16	Stamped & Formed
AT60-16-0144	Male Contact - Pin, Gold-plated	16	16-18	Stamped & Formed
AT62-16-0144	Female Contact - Socket, Gold-plated	16	16-18	Stamped & Formed
AT60-16-0122	Male Contact - Pin, Nickel-plated	16	16-18	Stamped & Formed
AT62-16-0122	Female Contact - Socket, Nickel-plated	16	16-18	Stamped & Formed
AT60-16-0644	Male Contact - Pin, Gold-plated	16	18-20	Stamped & Formed
AT62-16-0644	Female Contact - Socket, Gold-plated	16	18-20	Stamped & Formed
AT60-16-0622	Male Contact - Pin, Nickel-plated	16	18-20	Stamped & Formed
AT62-16-0622	Female Contact - Socket, Nickel-plated	16	18-20	Stamped & Formed
AT60-16-0844	Male Contact - Pin, Gold-plated	16	20-22	Stamped & Formed
AT62-16-0844	Female Contact - Socket, Gold-plated	16	20-22	Stamped & Formed
AT60-16-0822	Male Contact - Pin, Nickel-plated	16	20-22	Stamped & Formed
AT62-16-0822	Female Contact - Socket, Nickel-plated	16	20-22	Stamped & Formed

Tooling - Stamped & Formed Contacts		
Part	Part Number	Description
	MFX-3950	Crimp Die - Size 16, 18-20AWG (S&F contacts only)
	MFX-3953	Crimp Die - Size 16, 16-18AWG (S&F contacts only)
	MFX-3975	Crimp Die - Size 16, 14-16AWG (S&F contacts only)
	MFX-3990	Crimp Die - Size 16, 20-22AWG (S&F contacts only)
	ATT-16-00	Hand Crimp Tool - Size 16, 14-16AWG (S&F contacts only)
	ATT-16-01	Hand Crimp Tool - Size 16, 18-20AWG (S&F contacts only)
	ATT-1612-03	Hand Crimp Tool - Size 16, 20-22AWG (S&F contacts only)

Amphenol Sine Systems
 44724 Morley Drive
 Clinton Township, MI 48036 USA
www.amphenol-sine.com
 09/2021