

**SF2040B**

**80.460 MHz**  
**SAW Filter**

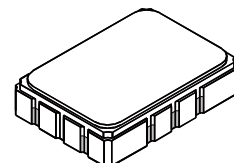

**SMP-03**

- *Designed for SDARS IF Receiver*
- *Low Insertion Loss*
- *5.0 X 7.0 mm Surface-Mount Case*
- *Differential or Single Ended Input and Output*
- *Complies with Directive 2002/95/EC (RoHS)*
- *Moisture Sensitivity Level: 1*
- *AEC-Q200 Qualified*

**Absolute Maximum Ratings**

Rating	Value	Units
Maximum Incident Power in Passband	+10	dBm
Max. DC voltage between any 2 terminals	30	VDC
Storage Temperature Range	-40 to +85	°C
Max Soldering Profile	265°C for 10 s	

**Electrical Characteristics**

Characteristic	Sym	Notes	Min	Typ	Max	Units
Nominal Center Frequency	$f_C$			80.460		MHz
Passband	Insertion Loss	IL		9.5	12.0	dB
	1dB Passband	$BW_{1}$	3.7	4.1		MHz
	15dB Bandwidth	$BW_{15}$		6.6	6.7	MHz
	30dB Bandwidth	$BW_{30}$		7.6	7.7	MHz
Amplitude Ripple over $f_c \pm 1.85$ MHz				0.5	1.10	dB <sub>p-p</sub>
Group Delay Variation over $f_c \pm 1.85$ MHz		GDV		60	150	ns <sub>p-p</sub>
Rejection	50 to 74.39 MHz		40	44		dB
	74.39 to 75.99 MHz		38	40		
	85.21 to 86.5 MHz		40	44		
	86.5 to 91.50 MHz		45	48		
	91.50 to 100 MHz		45	53		
Operating Temperature Range	$T_A$		-40		+85	°C
Frequency Temperature Coefficient	FTC			-18		ppm/°C
Differential Input			175 ohms			
Differential Output			1000 ohms			
Case Style			SMP-03 7 x 5 mm Nominal Footprint			
Lid Symbolization (YY=year, WW=week, S=shift, ## = Sequence Code)			RFM, SF2040B, <u>YYWWS##</u>			

**Electrical Connections**

Connection	Terminals
Port 1 Hot	10
Port 1 Ground Return	1
Port 2 Hot	5
Port 2 Ground Return	6
Case Ground	All Others



**CAUTION: Electrostatic Sensitive Device. Observe precautions for handling.**

**NOTES:**

1. The design, manufacturing process, and specifications of this device are subject to change.
2. US or International patents may apply.
3. RoHS compliant from the first date of manufacture.

**Matching Circuit and Matching Component Values Used in G3 Sirius Radios**

(Refer to Sirius Radio G3 Chipset Application Note, Doc. #RX000104-B, Sec. 4.2.5)

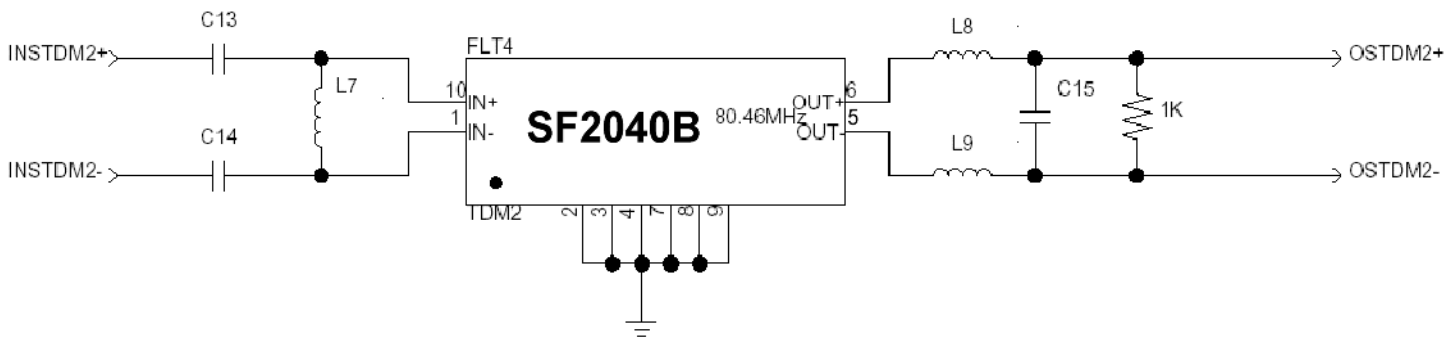

**TDM2 Narrowband SAW Matching Circuit**

**TDM2 Narrowband SAW Matching Values**

Reference Designator	Value
C13	12 pF
C14	12 pF
L7	240 nH
L8	390 nH
L9	390 pF
C15	10 pF

**Matching Circuit and Matching Component Values Used on Filter Demo Board**

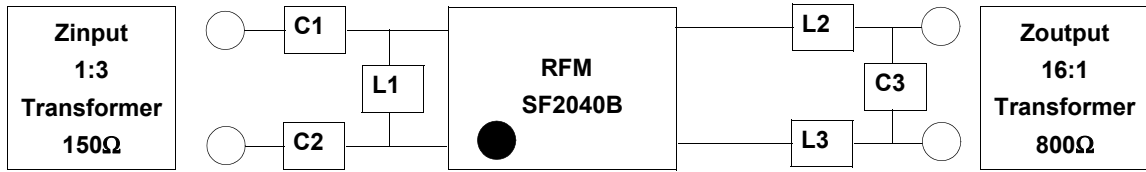

**SF2040B**  
**80.460 MHz**

**C1 = 9pF**  
**C2 = 9pF**  
**L1 = 270nH**  
**L2 = 330nH**  
**L3 = 330pF**  
**C3 = 12pF**

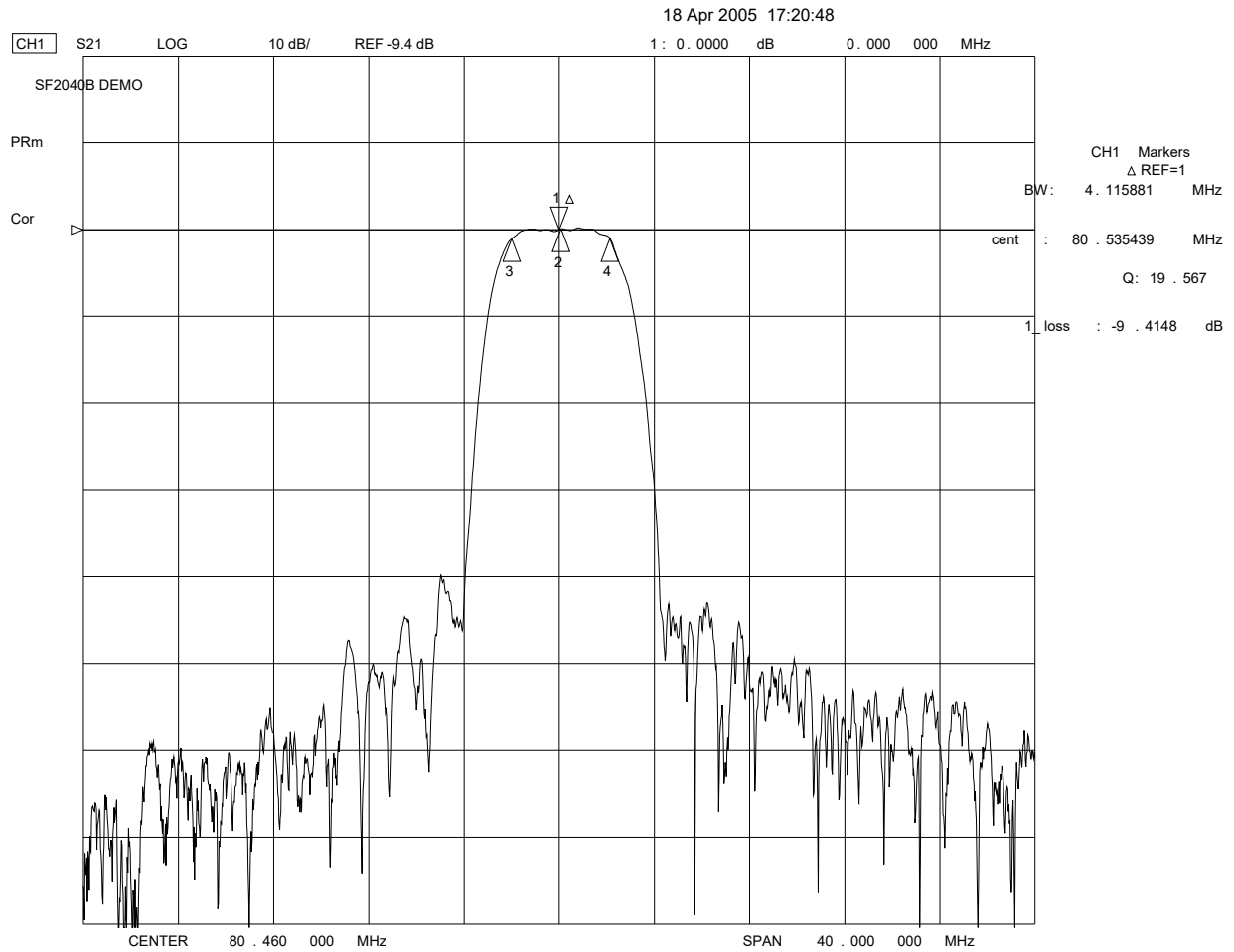

18 Apr 2005 17:17:25

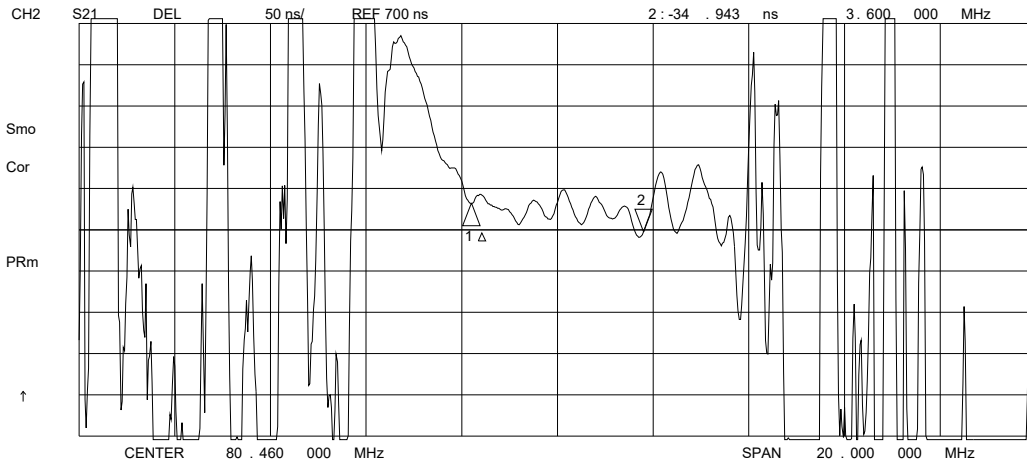
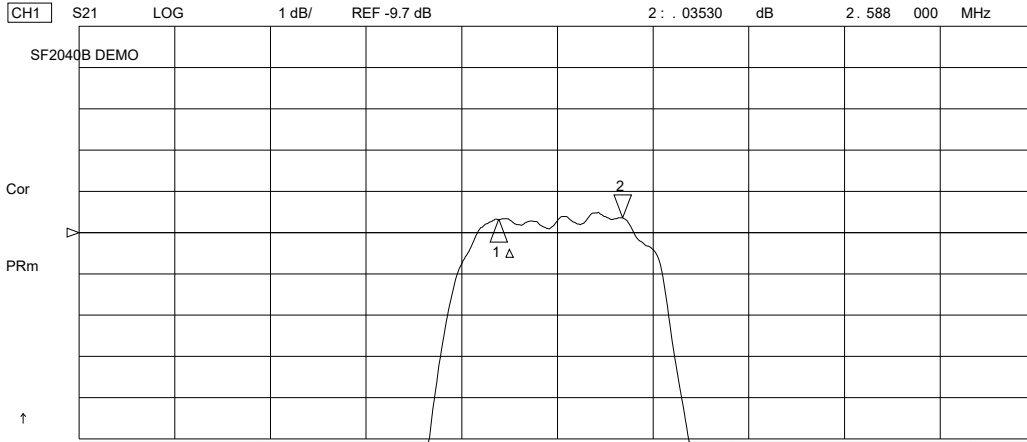

18 Apr 2005 17:09:52

CH1 S11 1 UFS

1: 46.854  $\Omega$  -23.961  $\Omega$  82.554 pF 80.460 000 MHz

SF2040B DEMO

PRm

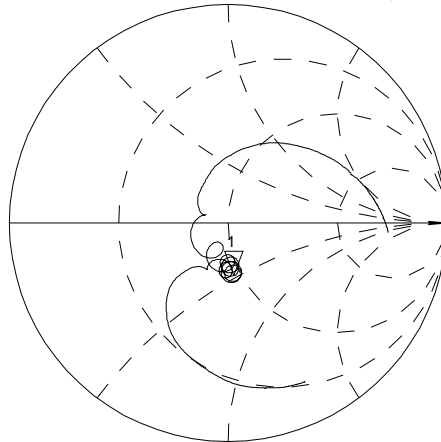

↑

CH2 S22 1 UFS

1: 41.250  $\Omega$  9.5586  $\Omega$  18.908 nH 80.460 000 MHz

PRm

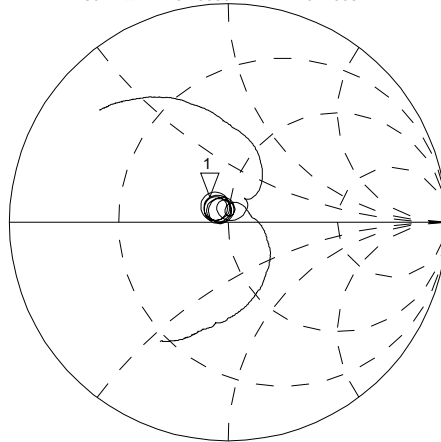

↑

CENTER 80.460 000 MHz

SPAN 20.000 000 MHz

# SMP-03 Case

## 10-Terminal Ceramic Surface-Mount Case

### 7 x 5 mm Nominal Footprint

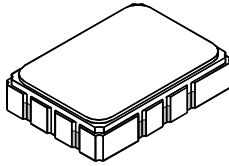

Recommended PCB Footprint

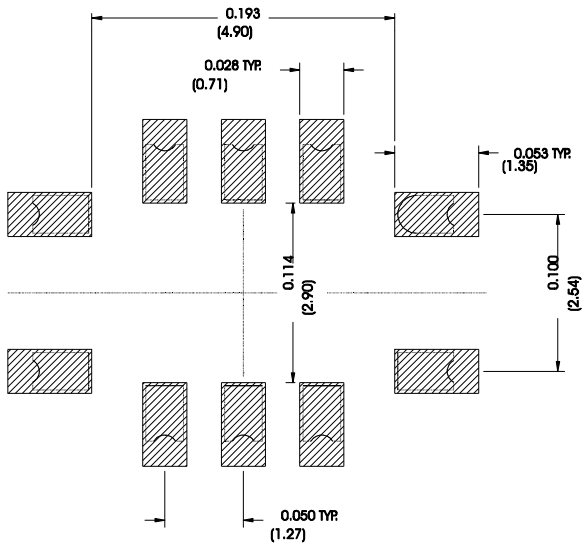

Case Dimensions						
Dimension	mm			Inches		
	Min	Nom	Max	Min	Nom	Max
A	6.80	7.00	7.20	0.268	0.276	0.283
B	4.80	5.00	5.20	0.189	0.197	0.205
C		1.65	2.00		0.065	0.079
D	.47	0.60	.73	0.019	0.024	0.029
E	2.41	2.54	2.67	0.095	0.100	0.105
H	0.87	1.0	1.13	0.034	0.039	0.044
J	4.87	5.00	5.13	0.192	0.197	0.202
K	2.87	3.00	3.13	0.113	0.118	0.123
P	1.14	1.27	1.40	0.045	0.050	0.055

Materials	
Solder Pad Termination	Au plating 30 - 60 ulnches (76.2-152 uM) over 80-200 ulnches (203-508 uM) Ni.
Lid	Fe-Ni-Co Alloy Electroless Nickel Plate (8-11% Phosphorus) 100-200 ulnches Thick
Body	Al <sub>2</sub> O <sub>3</sub> Ceramic

Electrical Connections		
Connection		Terminals
Port 1	Input or Return	10
	Return or Input	1
Port 2	Output or Return	5
	Return or Output	6
Ground		All others
Single Ended Operation		Return is ground
Differential Operation		Return is hot

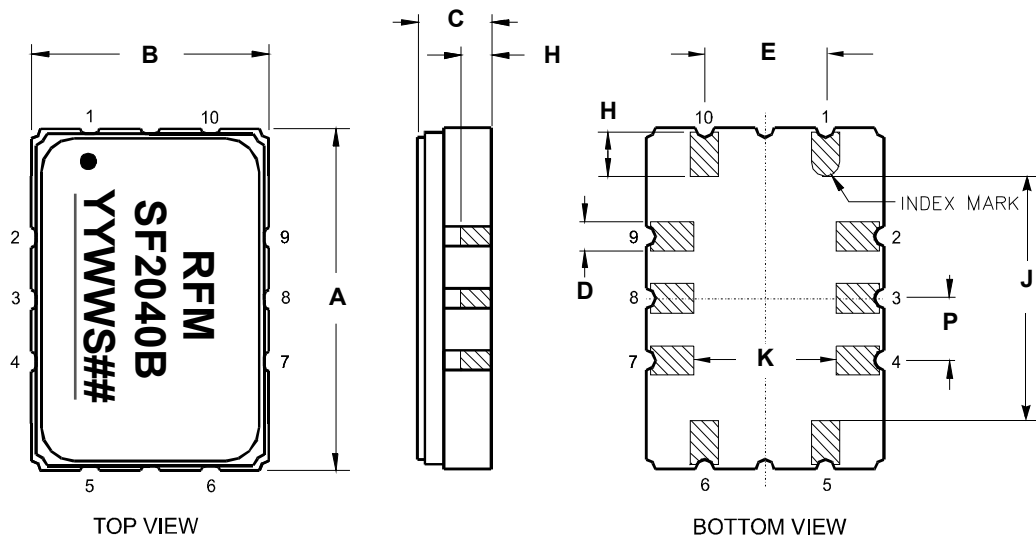

## Tape and Reel Specifications

Tape and Reel Standard per ANSI/EIA-481

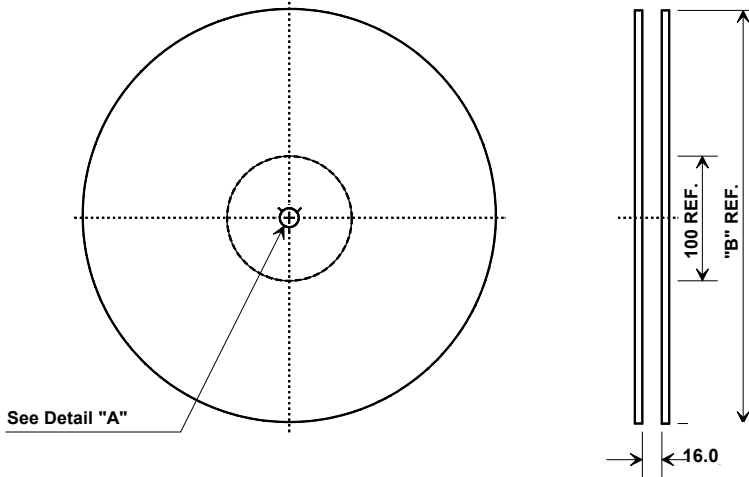

"B"		Quantity Per Reel
Inches	millimeters	
7	178	500
13	330	2000

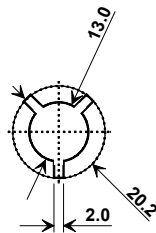

### COMPONENT ORIENTATION and DIMENSIONS

Carrier Tape Dimensions	
Ao	5.5 mm
Bo	7.5 mm
Ko	2.0 mm
Pitch	8.0 mm
W	16.0 mm

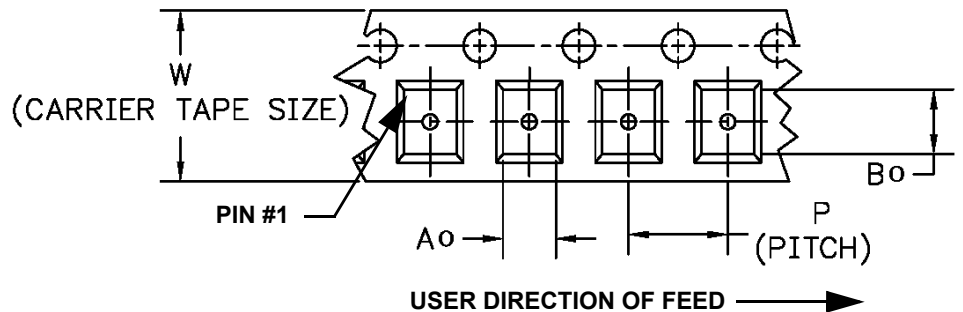
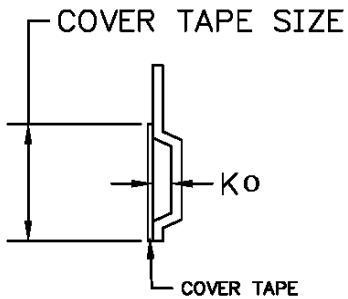

## Recommended Reflow Profile

1. Preheating shall be fixed at 150~180°C for 60~90 seconds.
2. Ascending time to preheating temperature 150°C shall be 30 seconds min.
3. Heating shall be fixed at 220°C for 50~80 seconds and at 260°C+0/-5°C peak (10 seconds).
4. Time: 5 times maximum.

