

DATE	REV.	ECN	APP'D BY
2-23-15	A5	10262	ADB
3-11-16	A6	10601	TRM

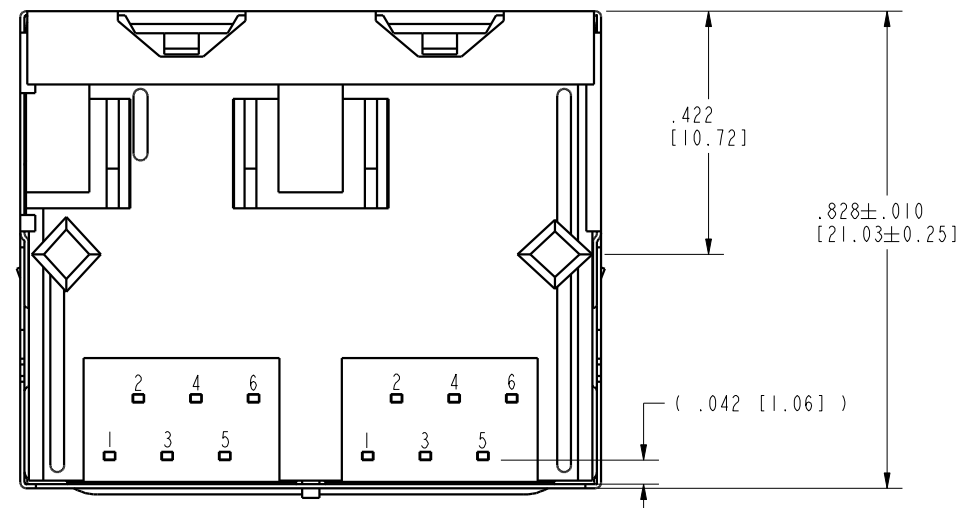

- NOTES:
 1. CONNECTOR MATERIALS:
 HOUSING: THERMOPLASTIC UL94 V-0
 CONTACT/SHIELD: COPPER ALLOY
 SHIELD PLATING: NICKEL OR TIN
 CONTACT PLATING: SELECTIVE GOLD IN CONTACT AREA
 SEE CHART FOR PART NUMBER
 2. FOR PRODUCT SPECIFICATION SEE PRO22-01
 3. DIMENSIONS AND TOLERANCES COMPLY WITH TIA-1096 STANDARD.

50 MICRO-INCHES [1.27um]	SS-666602S-A-NF-50
30 MICRO-INCHES [0.76um]	SS-666602S-A-NF
CONTACT PLATING IN MATING AREA	PART NUMBER

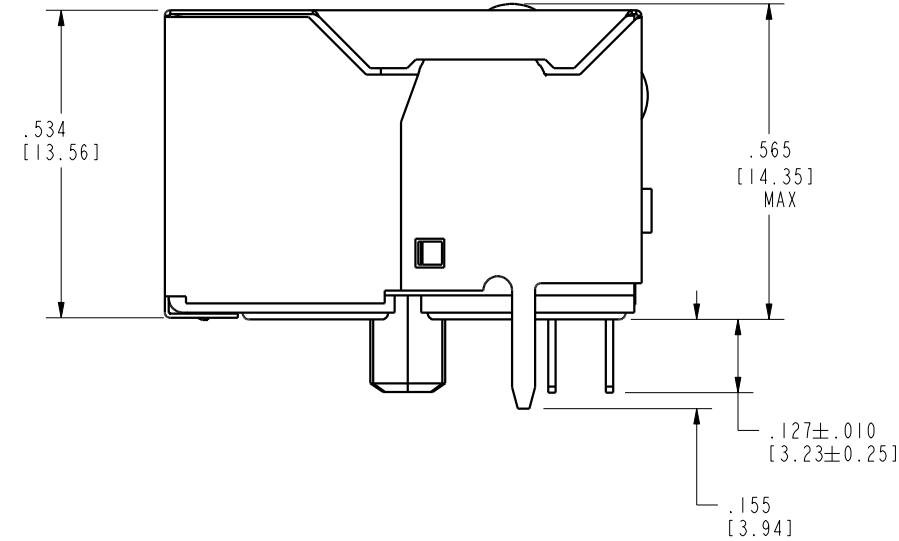
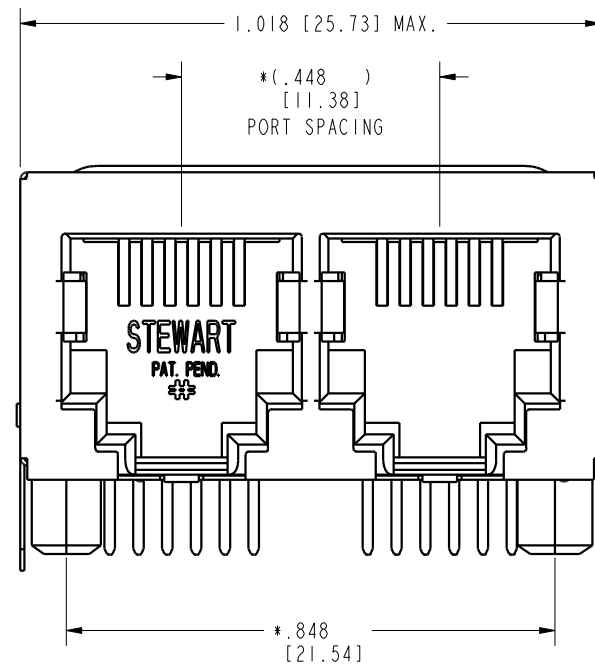
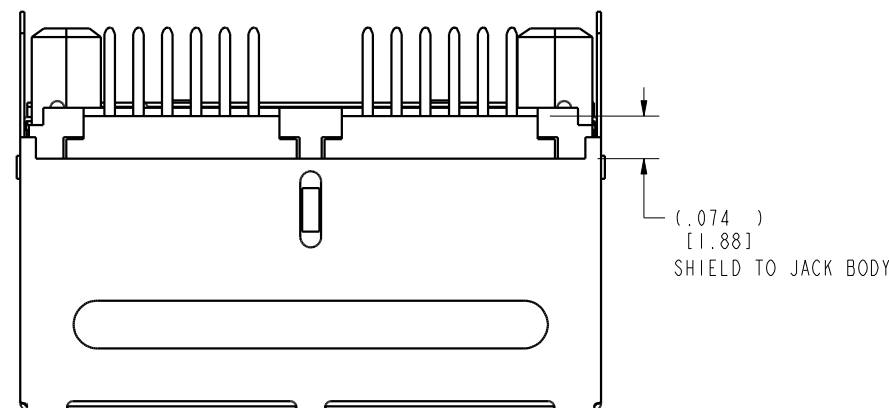

THIRD ANGLE PROJECTION

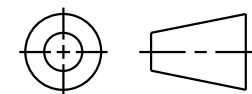

11118 Susquehanna Trail South
 Glen Rock, PA 17327-9199
 (717) 235-7512
<http://www.stewartconnector.com>

DO NOT SCALE DRAWING

DRAWING IS SUBJECT TO CHANGE WITHOUT NOTICE

DIMENSIONS: INCHES [METRIC]

UNLESS OTHERWISE SPECIFIED
 TOLERANCES ARE ±.005 [0.13]
 ANGLES ARE ±1°

SHEET NO.
 1 OF 2

EMI-RFI ONE PIECE SHIELDED, ESD GROUND
 2 PORT RJ11 HARMONICA JACK W/O PANEL GROUNDS

THIS DRAWING AND THE SUBJECT MATTER SHOWN THEREON ARE CONFIDENTIAL AND THE PROPRIETARY PROPERTY OF STEWART CONNECTOR AND SHALL NOT BE REPRODUCED, COPIED, OR USED IN ANY MANNER WITHOUT PRIOR WRITTEN CONSENT OF STEWART CONNECTOR. ONE OR MORE U.S. PATENTS MAY APPLY TO THIS PRODUCT. FOR DETAILS, PLEASE VISIT: [HTTP://BELFUSE.COM/STEWART/STEWART_PATENTS/](http://BELFUSE.COM/STEWART/STEWART_PATENTS/)

DRN BY:	SAR	DATE	12-7-01
APPD BY:	JRC	DATE	1-16-02
DWG. NO.	CT660183	REV.	A6

B

B

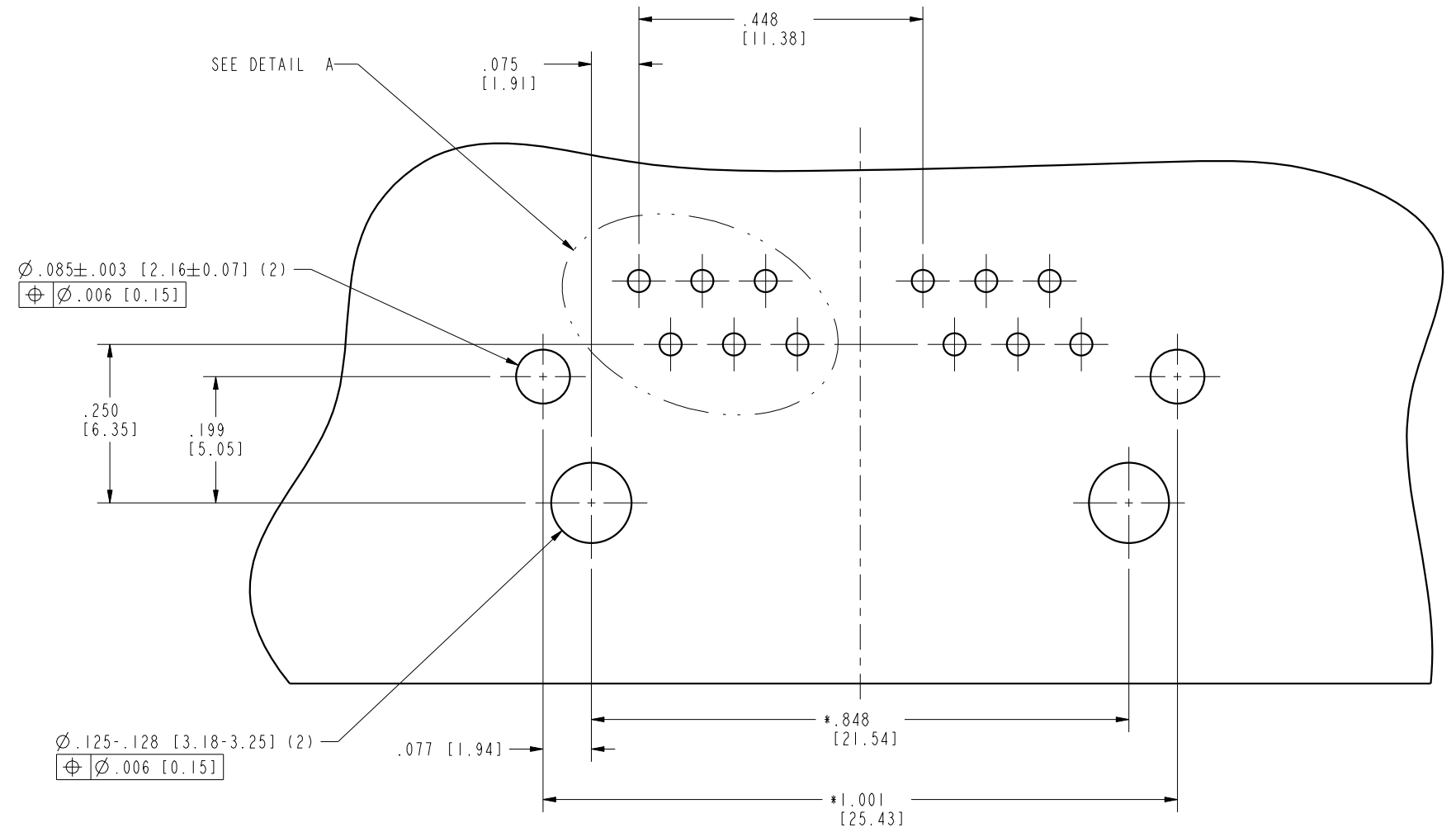
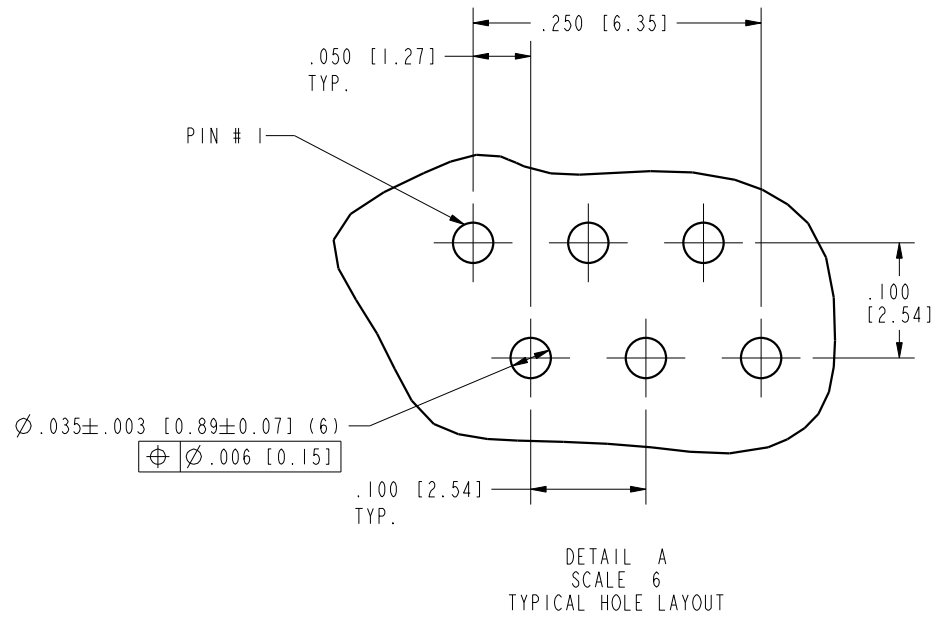

ALL CENTERLINE DIMENSIONS ARE BASIC

A

A



THIRD ANGLE PROJECTION 	 11118 Susquehanna Trail South Glen Rock, PA 17327-9199 (717) 235-7512 http://www.stewartconnector.com
DO NOT SCALE DRAWING DRAWING IS SUBJECT TO CHANGE WITHOUT NOTICE	EMI-RFI ONE PIECE SHIELDED, ESD GROUNDED 2 PORT RJ11 HARMONICA JACK W/O PANEL GROUNDS
DIMENSIONS: INCHES [METRIC] UNLESS OTHERWISE SPECIFIED TOLERANCES ARE $\pm .005$ [0.13] ANGLES ARE $\pm 1^\circ$	DRN BY: SAR DATE 12-7-01 APPD BY: JRC DATE 1-16-02
SHEET NO. 2 OF 2	DWG. NO. CT660183 REV. A6