

341/391 SERIES

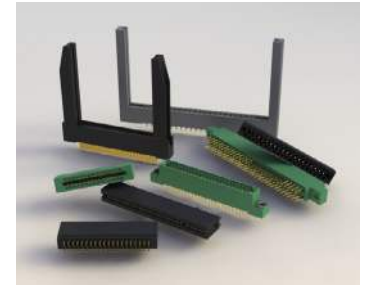

Card Edge Connectors 0.100" (3.96mm) Pitch

- 0.156" (3.96mm) contact spacing x 0.200" (5.08mm) row spacing
- Accepts 0.062" (1.57mm) nominal thickness P.C. board
- Low profile insulator body, 0.473" (12.01mm)
- Contact termination 0.045" (1.14mm) square wire wrap
- Single or dual row configurations
- Large variety of mounting options
- Pre-assembled card guides available
- Accepts between contact and in-contact polarizing keys
- RoHS Compliant



Insulator Material	UL 94V-0 Thermoplastic Polyester
Contact Material	Copper Alloy
Contact Plating	Gold Plating on mating area and Tin Plating on tails with Nickel underplating all over
Current Rating	3 amps
Contact Resistance	10 milliohms maximum
Dielectric Withstanding Voltage	1200 V AC rms at sea level between adjacent contacts
Insulation Resistance	5000 megaohms minimum
Operating Temperature	-40°C to +105°C
Insertion Force	16 oz (4.45 N) maximum per contact pair when tested with .070" (1.78mm) thick gauge
Withdrawal Force	1 oz (0.28 N) minimum per contact pair when tested with .054" (1.37mm) thick gauge

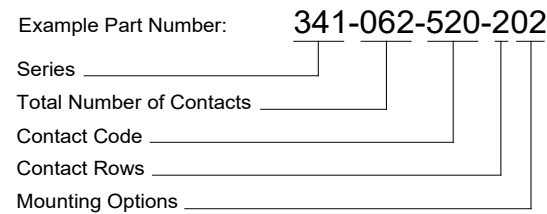

Series:

341
391

Insulator Color:

Green
Black

Total Number of Contacts:

005, 006, 060
010, 012, 120

Contact Rows:

Single Row
Dual Row

Contact Code:

500
520
521
522
524
555
556

Tail Description:

Wire Hole
P.C. Tail
P.C. Tail
P.C. Tail
P.C. Tail
Extender Board Bend
Extender Board Bend

Tail Size:

.050 x .013 (1.27 x 0.33)
.025 x .013 (0.64 x 0.33)
.025 x .013 (0.64 x 0.33)
.025 x .013 (0.64 x 0.33)
.025 x .013 (0.64 x 0.33)
(Code 500 Contacts)
(Code 521 Contacts)

Tail Length "G":

.220 (5.59)
.125 (3.18)
.260 (6.60)
.375 (9.53)
.100 (2.54)

Contact Rows:

1
2

Description:

Single Row
Dual Row

Mounting Options:

01
02
03
04
07
08

Description:

No Mounting Lug
Ø.128" (Ø3.25mm) Mounting Holes
Ø.116" (Ø2.95mm) I.D. Floating Eyelets
Ø.156" (Ø3.96mm) Mounting Holes
M3-0.5 Metric Threaded Inserts
#4-40 Unified Threaded Inserts

Mounting Options:

Description:

01 No Mounting Lug
02 Ø.128" (Ø3.25mm) Mounting Holes
03 Ø.116" (Ø2.95mm) I.D. Floating Eyelets
04 Ø.156" (Ø3.96mm) Mounting Holes
07 M3-0.5 Metric Threaded Inserts
08 #4-40 Unified Threaded Inserts
58 .468" (11.89mm) Offset Card Guides

Ordering Code Notes:

- 1) All connector sizes up to 60 contacts single row / 120 contacts dual row are available upon request.
- 2) The 500 contact code is only available in the 341 series. Green Dialyl Phthalate insulator material will be supplied.
- 3) For details of the extender board bends refer to next pages.
- 4) For details of the mounting options refer to page 3.



Card Edge Connectors 0.100" (3.96mm) Pitch

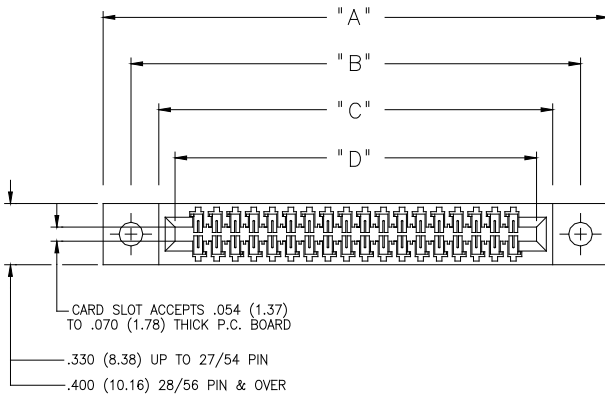

IN-CONTACT
POLARIZING KEY
P/N 321-240-328



BETWEEN CONTACT
POLARIZING KEY
P/N 341-240-318

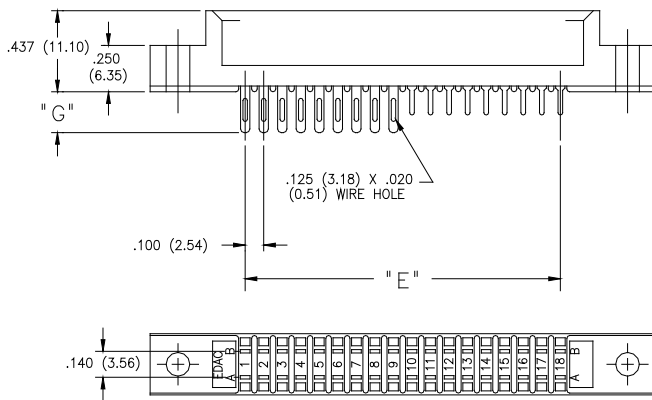
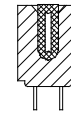

SECTION THROUGH
CONTACT POSITION

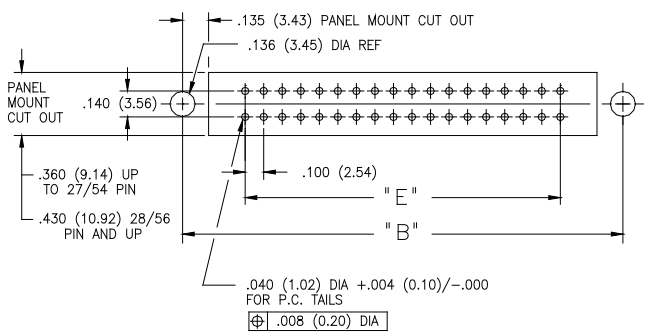
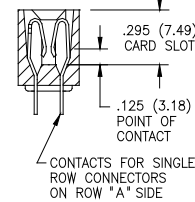

CONNECTOR MOUNTING PATTERN

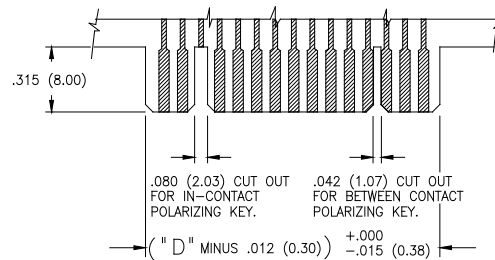

RECOMMENDED DAUGHTER BOARD

NUMBER OF CONTACTS		"A"		"B"		"C"		"D"		"D"	
Single	Double	Inch	mm	Inch	mm	Inch	mm	Inch	mm	Inch	mm
5	10	1.375	(34.93)	1.075	(27.31)	0.775	(19.69)	0.600	(15.24)	0.400	(10.16)
6	12	1.475	(37.47)	1.175	(29.85)	0.875	(22.23)	0.700	(17.78)	0.500	(12.7)
10	20	1.875	(47.63)	1.575	(40.01)	1.275	(32.39)	1.100	(27.94)	0.900	(22.86)
15	30	2.375	(60.33)	2.075	(52.71)	1.775	(45.09)	1.600	(40.64)	1.400	(35.56)
18	36	2.675	(67.95)	2.375	(60.33)	2.075	(52.71)	1.900	(48.26)	1.700	(43.18)
22	44	3.075	(78.11)	2.775	(70.49)	2.475	(62.87)	2.300	(58.42)	2.100	(53.34)
25	50	3.375	(85.73)	3.075	(78.11)	2.775	(70.49)	2.600	(66.04)	2.400	(60.96)
28	56	3.675	(93.35)	3.375	(85.73)	3.075	(78.11)	2.900	(73.66)	2.700	(68.58)
30	60	3.875	(98.43)	3.575	(90.81)	3.275	(83.19)	3.100	(78.74)	2.900	(73.66)
36	72	4.475	(113.67)	4.175	(106.05)	3.875	(98.43)	3.700	(93.98)	3.500	(88.9)
40	80	4.875	(123.83)	4.575	(116.21)	4.275	(108.59)	4.100	(104.14)	3.900	(99.06)
43	86	5.175	(131.45)	4.875	(123.83)	4.575	(116.21)	4.400	(111.76)	4.200	(106.68)
50	100	5.875	(149.23)	5.575	(141.61)	5.275	(133.99)	5.100	(129.54)	4.900	(124.46)
60	120	6.875	(174.63)	6.575	(167.01)	6.275	(159.39)	6.100	(154.94)	5.900	(149.86)

Card Edge Connectors 0.100" (3.96mm) Pitch

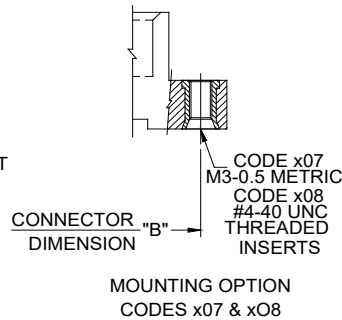
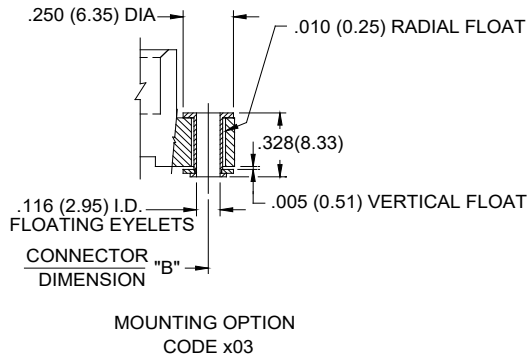
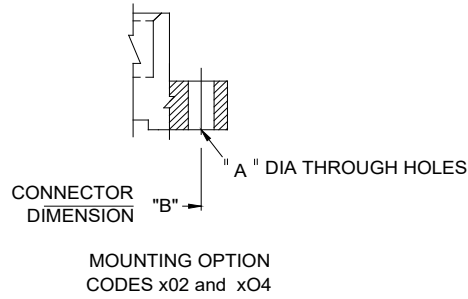
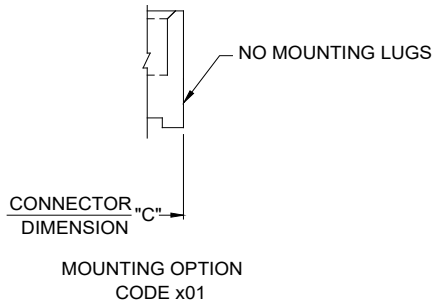

CODE X02 AND X04- THROUGH MTG. HOLES		
	CODE X02	CODE X04
"A" DIA.	0.128(3.25)	0.156(3.96)
CODE X07 AND X08- THREADED INSERTS		
	CODE X07	CODE X08
INSERT	M3-0.5(METRIC)	#4-40 UNC

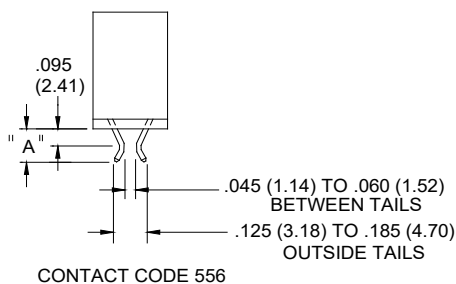
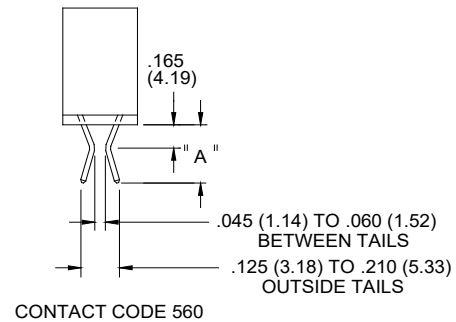
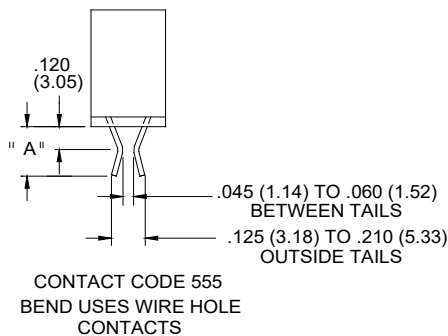

MTG. OPTION	A
555	0.205(5.21)
556	0.235(5.97)
560	0.365(9.27)