

## SPECIFICATIONS CDSX15 SERIES

### PACKAGE DIMENSIONS

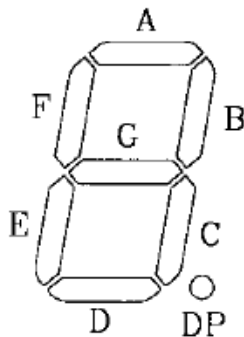

CDSC15 SERIES

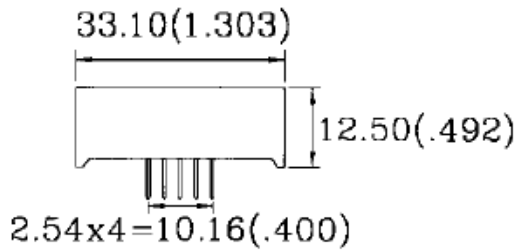
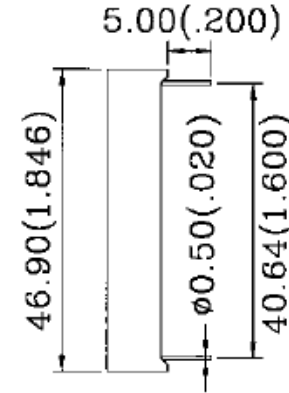
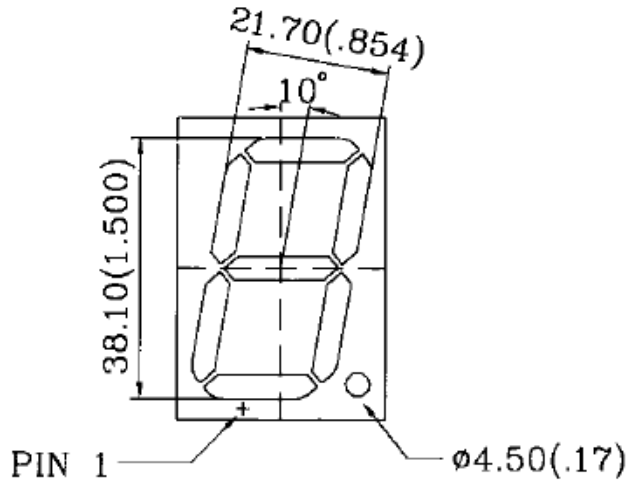
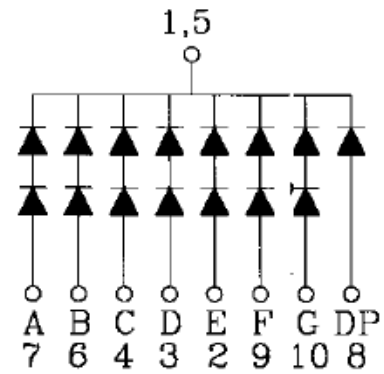

CDSA15 SERIES

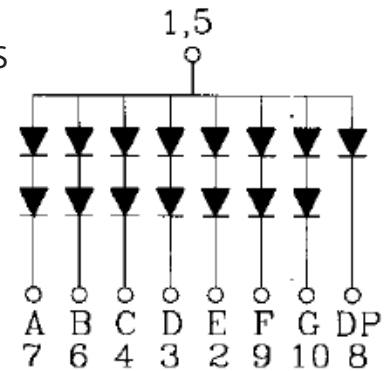

**Notes:**

1. All dimensions are in millimeters (inches).
2. Tolerance is ± 0.25mm (0.01") unless otherwise noted.
3. Specifications are subject to change without notice.



ChromeLED Corp. reserves the right to make changes at any time in order to supply the best product possible. The most current version of this document will always be available at: [www.chromeled.com](http://www.chromeled.com)

**PART NUMBER DESCRIPTION**

| Part Number | Chip Material | Color of Emission | Lens Type     | Description    |
|-------------|---------------|-------------------|---------------|----------------|
| CDSA15R1W   | GaAsP         | Red               | White Segment | Common Anode   |
| CDSC15R1W   | GaAsP         | Red               | White Segment | Common Cathode |
| CDSA15RR1W  | AlGaAs        | Super Red         | White Segment | Common Anode   |
| CDSC15RR1W  | AlGaAs        | Super Red         | White Segment | Common Cathode |
| CDSA15Y1W   | GaAsP         | Yellow            | White Segment | Common Anode   |
| CDSC15Y1W   | GaAsP         | Yellow            | White Segment | Common Cathode |
| CDSA15G1W   | GaP           | Green             | White Segment | Common Anode   |
| CDSC15G1W   | GaP           | Green             | White Segment | Common Cathode |
| CDSA15B1W   | GaN           | Blue              | White Segment | Common Anode   |
| CDSC15B1W   | GaN           | Blue              | White Segment | Common Cathode |

**OPTICAL-ELECTRICAL CHARACTERISTICS**
**(TA=25°C)**

| Part Number | Wave-length (nm) | Absolute Maximum |                |                 |                 | Electro-Optical Characteristics |     |     |                |                      |     |
|-------------|------------------|------------------|----------------|-----------------|-----------------|---------------------------------|-----|-----|----------------|----------------------|-----|
|             |                  | $\Delta\lambda$  | P <sub>D</sub> | I <sub>AF</sub> | I <sub>PF</sub> | V <sub>F</sub> (V)              |     |     | I <sub>F</sub> | I <sub>v</sub> (mcd) |     |
|             |                  | nm               | mW             | mA              | (Peak)          | Min                             | Typ | Max | (Rec)          | Min                  | Typ |
| CDSA15R1W   | 625              | 45               | 50             | 30              | 100             | 3.4                             | 3.7 | 5.0 | 10             | 4.8                  | 18  |
| CDSC15R1W   | 625              | 45               | 50             | 30              | 100             | 3.4                             | 3.7 | 5.0 | 10             | 4.8                  | 18  |
| CDSA15RR1W  | 640              | 20               | 50             | 20              | 100             | 3.2                             | 3.6 | 5.2 | 10             | 18                   | 60  |
| CDSC15RR1W  | 640              | 20               | 50             | 20              | 100             | 3.2                             | 3.6 | 5.2 | 10             | 18                   | 60  |
| CDSA15Y1W   | 588              | 30               | 50             | 30              | 100             | 3.4                             | 4.1 | 5.2 | 10             | 3                    | 8   |
| CDSC15Y1W   | 588              | 30               | 50             | 30              | 100             | 3.4                             | 4.1 | 5.2 | 10             | 3                    | 8   |
| CDSA15G1W   | 568              | 30               | 40             | 25              | 100             | 3.4                             | 4.1 | 5.2 | 10             | 8                    | 24  |
| CDSC15G1W   | 568              | 30               | 40             | 25              | 100             | 3.4                             | 4.1 | 5.2 | 10             | 8                    | 24  |
| CDSA15B1W   | 470              | 30               | 65             | 25              | 100             | -                               | 6.6 | 7.6 | 10             | 6                    | 7.5 |
| CDSC15B1W   | 470              | 30               | 65             | 25              | 100             | -                               | 6.6 | 7.6 | 10             | 6                    | 7.5 |



ChromeLED Corp. reserves the right to make changes at any time in order to supply the best product possible. The most current version of this document will always be available at: [www.chromeled.com](http://www.chromeled.com)

**ABSOLUTE MAXIMUM RATINGS**
**(TA=25°C)**

|                           |                      |                                         |         |
|---------------------------|----------------------|-----------------------------------------|---------|
| Reverse Voltage           | 5V                   | Spectral Line half-width ( $\lambda$ )  | nm      |
| Reverse Current (Vr = 5V) | 100 $\mu$ A          | Power Dissipation (Pd)                  | mW      |
| Operating Temperature     | -40°C~+85°C          | Peak Forward Current (Duty 1/10, @ KHz) | mA      |
| Storage Temperature       | -40°C~+85°C          | Recommended Operation Current (If Rec)  | mA      |
| Soldering Temperature     | 250C~260C for 3 sec. | Average Luminous Intensity (If=10)      | $\mu$ A |



ChromeLED Corp. reserves the right to make changes at any time in order to supply the best product possible. The most current version of this document will always be available at: [www.chromeled.com](http://www.chromeled.com)

**OPTICAL CHARACTERISTIC CURVES - RED**

Forward Current vs. Forward Voltage

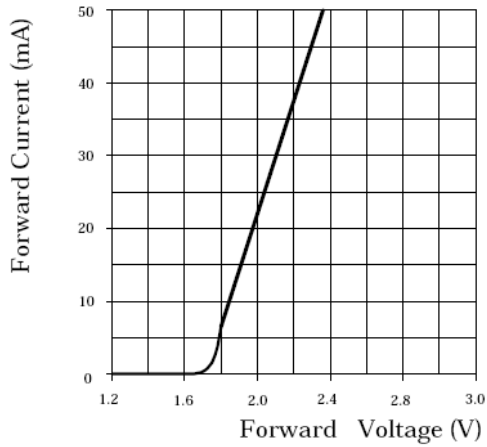

Relative Intensity vs. Forward Current

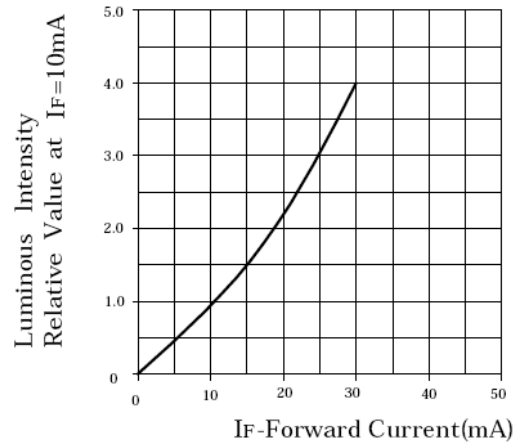

Forward Current vs. Ambient Temperature

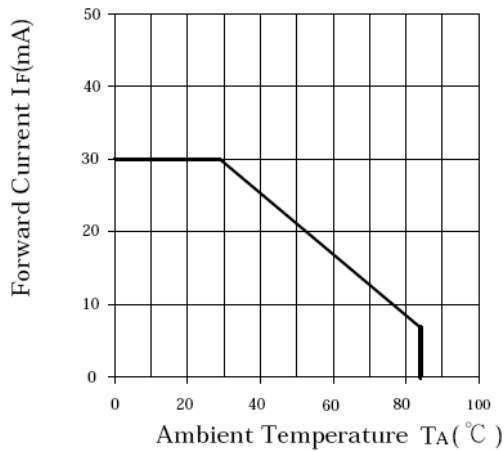

Luminous Intensity vs. Ambient Temperature

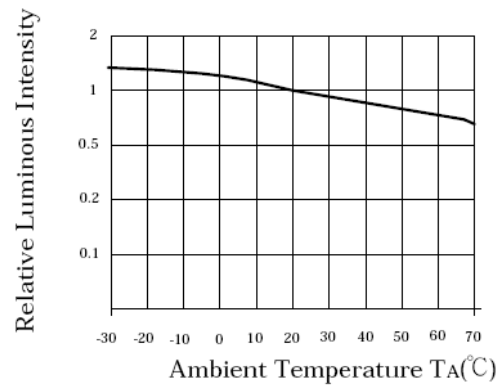

ChromeLED Corp. reserves the right to make changes at any time in order to supply the best product possible. The most current version of this document will always be available at: [www.chromeled.com](http://www.chromeled.com)

## OPTICAL CHARACTERISTIC CURVES - SUPER RED

Forward Current vs. Forward Voltage

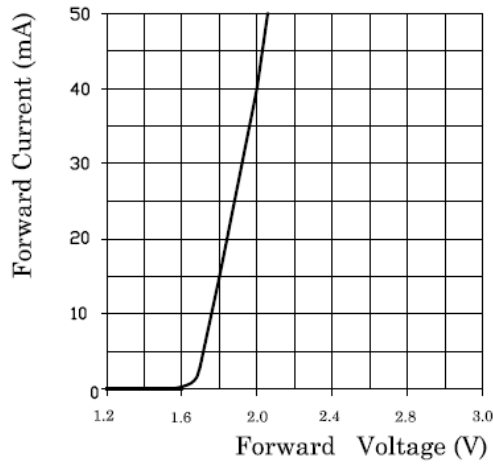

Relative Intensity vs. Forward Current

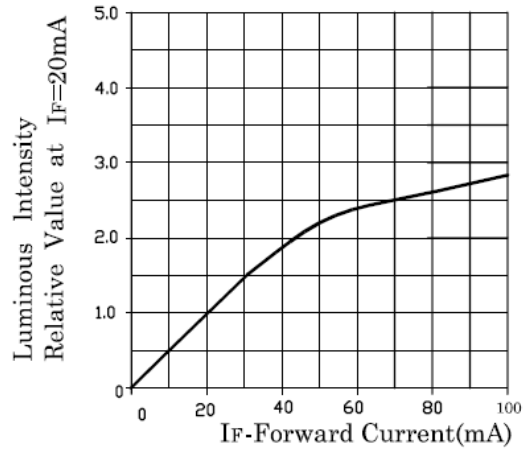

Forward Current vs. Ambient Temperature

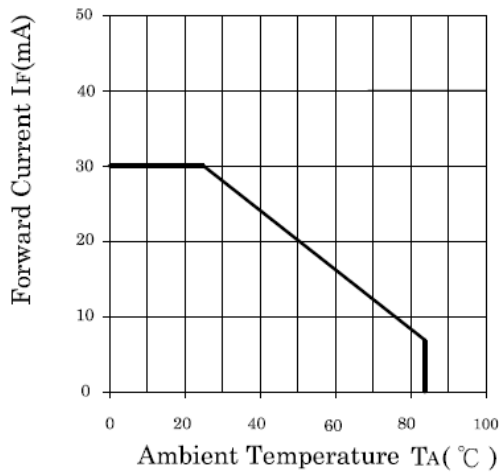

Luminous Intensity vs. Ambient Temperature

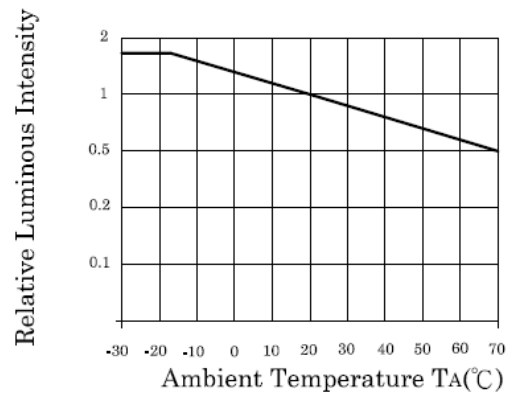

ChromeLED Corp. reserves the right to make changes at any time in order to supply the best product possible. The most current version of this document will always be available at: [www.chromeled.com](http://www.chromeled.com)

**OPTICAL CHARACTERISTIC CURVES - YELLOW**

Forward Current vs. Forward Voltage

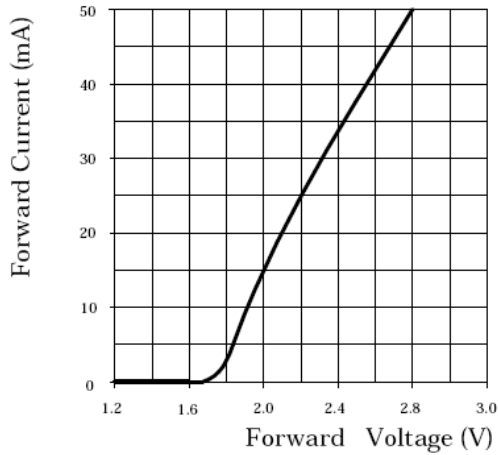

Relative Intensity vs. Forward Current

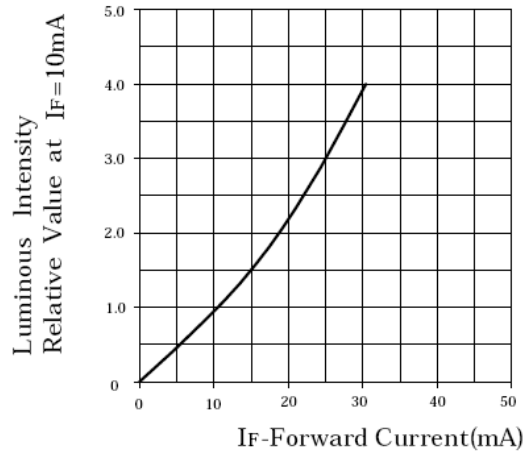

Forward Current vs. Ambient Temperature

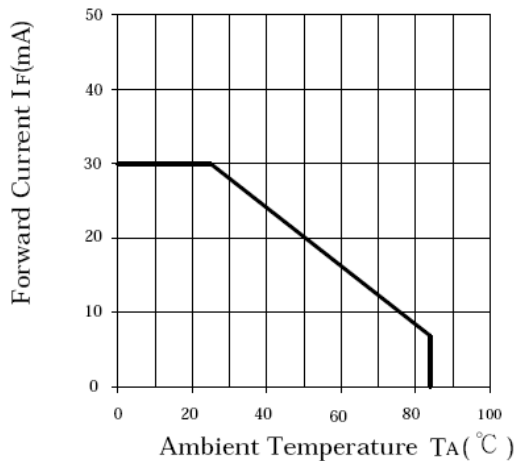

Luminous Intensity vs. Ambient Temperature

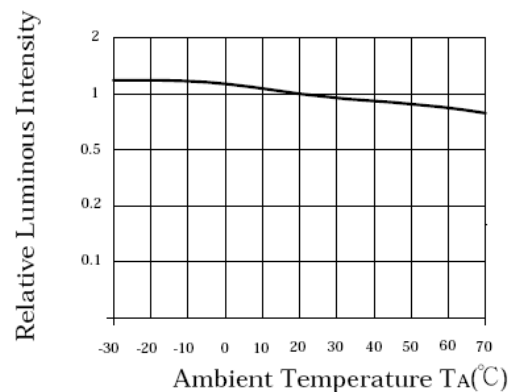

ChromeLED Corp. reserves the right to make changes at any time in order to supply the best product possible. The most current version of this document will always be available at: [www.chromeled.com](http://www.chromeled.com)

## OPTICAL CHARACTERISTIC CURVES - GREEN

Forward Current vs. Forward Voltage

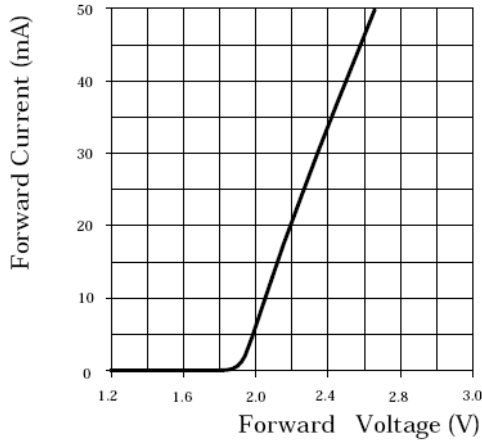

Relative Intensity vs. Forward Current

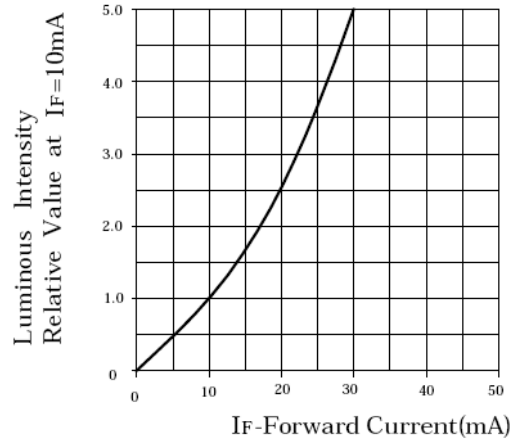

Forward Current vs. Ambient Temperature

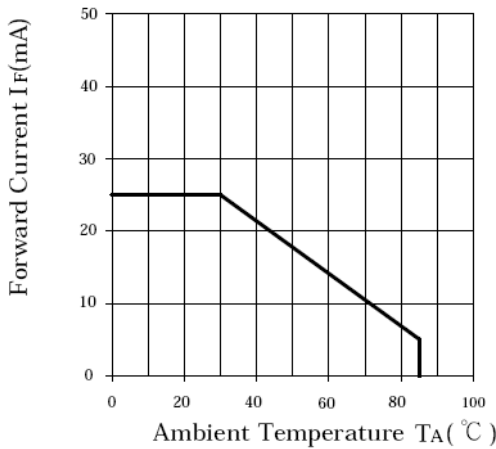

Luminous Intensity vs. Ambient Temperature

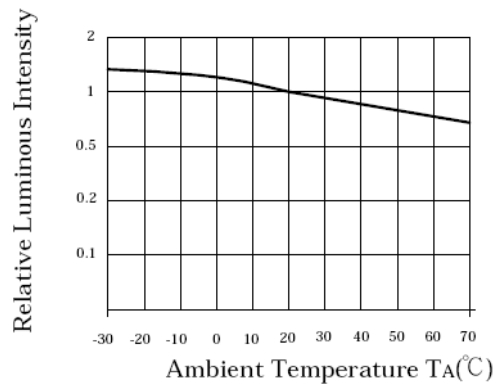

ChromeLED Corp. reserves the right to make changes at any time in order to supply the best product possible. The most current version of this document will always be available at: [www.chromeled.com](http://www.chromeled.com)

## OPTICAL CHARACTERISTIC CURVES - BLUE

Forward Current vs. Forward Voltage

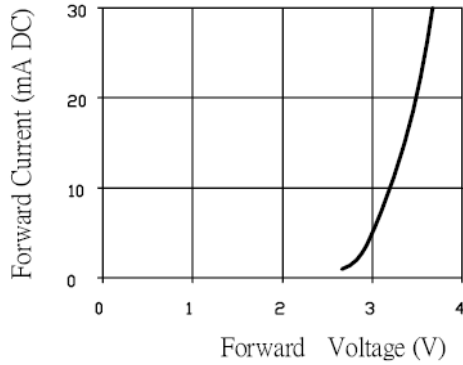

Relative Intensity vs. Forward Current

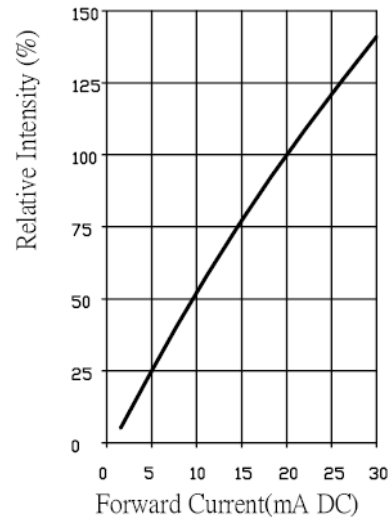

Forward Current vs. Ambient Temperature

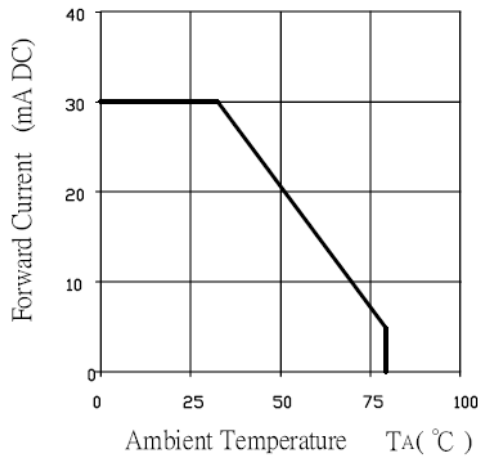

Luminous Intensity vs. Ambient Temperature

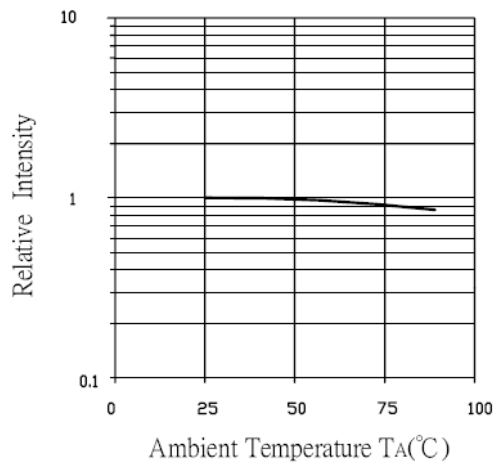

ChromeLED Corp. reserves the right to make changes at any time in order to supply the best product possible. The most current version of this document will always be available at: [www.chromeled.com](http://www.chromeled.com)



## SOLDERING CONDITIONS - DISPLAY

\* Solder the LED no closer than 3mm from the base of the epoxy bulb. Soldering beyond the base of the tie bar is recommended.

\* Recommended soldering conditions

| Dip Soldering           |                                              |
|-------------------------|----------------------------------------------|
| Pre-Heat                | 100 °C Max                                   |
| Pre-Heat Time           | 60 Second Max                                |
| Solder Bath Temperature | 260 °C Max                                   |
| Dipping Time            | 5 Second Max                                 |
| Dipping Position        | No lower than 3mm from the base of the epoxy |

| Hand Soldering |                                               |                                               |
|----------------|-----------------------------------------------|-----------------------------------------------|
|                | 3mm Series                                    | Others                                        |
| Temperature    | 300 °C Max                                    | 350 °C Max                                    |
| Soldering Time | 3 Second Max                                  | 3 Second Max                                  |
| Position       | No closer than 3mm from the base of the epoxy | No closer than 3mm from the base of the epoxy |

\* Do not apply any stress to the lead. Particularly when heated.

\* The LED must not be repositioned after soldering.

\* After soldering the LEDs, the epoxy bulb should be protected from mechanical shock or vibration until the LEDs return to room temperature.

\* Direct soldering onto a PC board should be avoided. Mechanical stress to the resin may be caused by the PC board warping or from the clinching and cutting of the leadframes. When it is absolutely necessary, the LEDs may be mounted in this fashion, but, the user will assume responsibility for any problems. Direct soldering should only be done after testing has confirmed that no damage, such as wire bond failure or resin deterioration, will occur. LEDs should not be soldered directly to double sided PC boards because the heat will deteriorate the epoxy resin.

\* When it is necessary to clamp the LEDs to prevent soldering failure, it is important to minimize the mechanical stress on the LEDs.

\* Cut the LED leadframes at room temperature. Cutting the leadframes at high temperature may cause LED failure.



ChromeLED Corp. reserves the right to make changes at any time in order to supply the best product possible. The most current version of this document will always be available at: [www.chromeled.com](http://www.chromeled.com)