

FLX-D37F/16RSC/24DC/DO/TDC3K - Active module



2908891

<https://www.phoenixcontact.com/us/products/2908891>

Please be informed that the data shown in this PDF document is generated from our online catalog. Please find the complete data in the user documentation. Our general terms of use for downloads are valid.



Migration board for converting TDC3000 to modern control platforms, digital output, 16 channel with relays

Your advantages

- Panel mount to existing TDC3000 chassis
- Compatible with existing pluggable field wiring connectors
- DSUB control side connection
- Terminal blocks for power supply
- Per channel fusing

Commercial data

Item number	2908891
Packing unit	1 pc
Sales key	C421
Product key	CK21B3
GTIN	4055626733081
Weight per piece (including packing)	840 g
Weight per piece (excluding packing)	800 g
Customs tariff number	85176200
Country of origin	US

Technical data

Notes

General	For proper use, the specifications of the installation directive (see Downloads) must be observed.
---------	--

Product properties

Product type	Interface module
Mechanical service life	3x 10 ⁷ cycles

Insulation characteristics

Overvoltage category	II
Pollution degree	2

Electrical properties

Supported controller HONEYWELL TDC3000

Suitable I/O card	TDOR12
-------------------	--------

Input data

Nominal input voltage U_N	24 V DC
Input voltage range in reference to U_N	0.8 ... 1.1
Input voltage range	19.2 V DC ... 26.4 V DC
Typical input current at U_N	20 mA
Typical response time	8 ms
Typical release time	10 ms
Protective circuit	Freewheeling diode; Freewheeling diode

Output data

Switching

Contact switching type	1 changeover contact
Contact material	AgNi
Maximum switching voltage	125 V AC/DC
Minimum switching voltage	12 V
Limiting continuous current	5 A (fuse limited)
Min. switching current	10 mA (at 12 V)
Interrupting rating (ohmic load) max.	120 W (at 24 V DC)
	58 W (at 48 V DC)
	48 W (at 60 V DC)
	50 W (110 V DC)
	600 VA (120 V AC)
Error detection (line break / short-circuit)	no

Connection data

FLX-D37F/16RSC/24DC/DO/TDC3K - Active module



2908891

<https://www.phoenixcontact.com/us/products/2908891>

Controller level

Connection method	D-SUB 37 female connector
Number of connections	1
Number of positions	37

Field level

Connection method	pluggable
-------------------	-----------

Signaling

Status display present	Yes
------------------------	-----

Dimensions

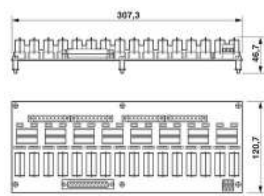
Dimensional drawing	
Width	307.3 mm
Height	120.7 mm
Depth	46.7 mm

Environmental and real-life conditions

Ambient conditions

Ambient temperature (operation)	-40 °C ... 70 °C
Ambient temperature (storage/transport)	-40 °C ... 75 °C
Altitude	< 2000 m
Permissible humidity (operation)	< 90 %

Mounting

Mounting type	TDC3000 chassis
Mounting position	any

Drawings

Circuit diagram

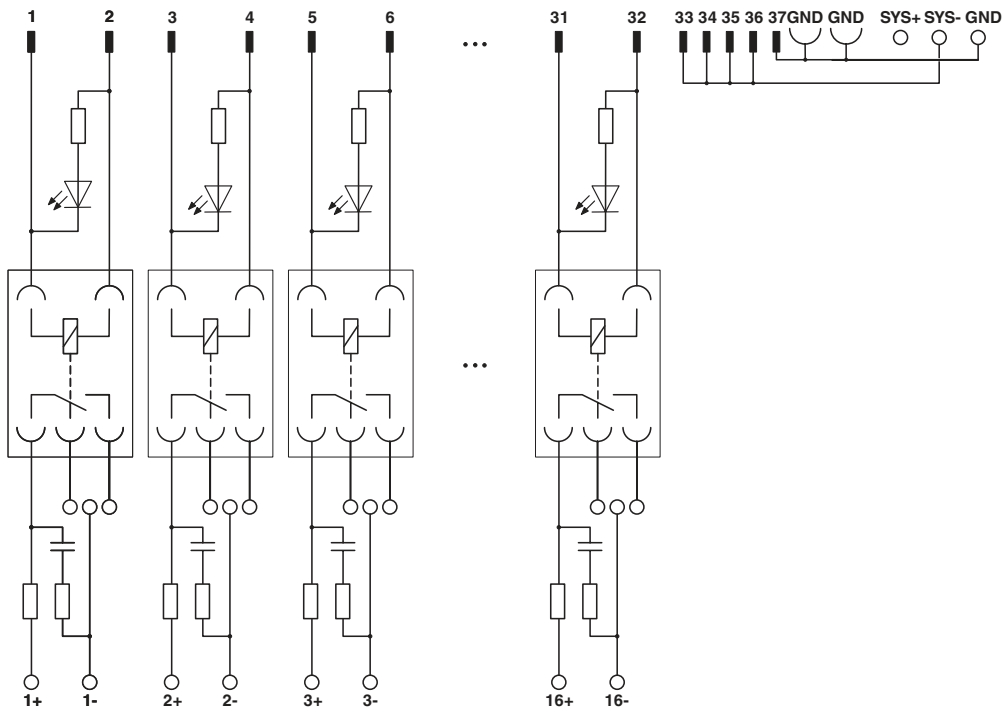

Dimensional drawing

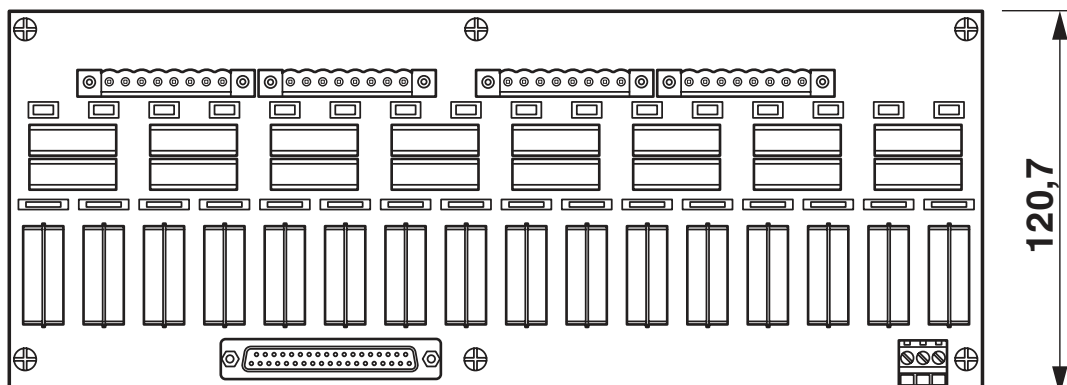
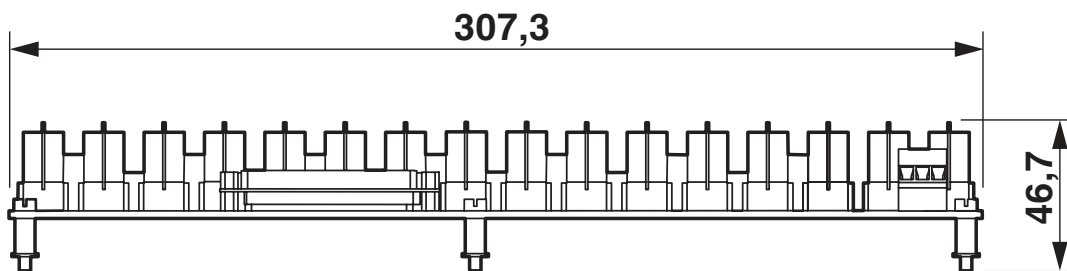

FLX-D37F/16RSC/24DC/DO/TDC3K - Active module





2908891

<https://www.phoenixcontact.com/us/products/2908891>

Approvals

To download certificates, visit the product detail page: <https://www.phoenixcontact.com/us/products/2908891>

 CSA Approval ID: 108860_0_000				
	Nominal voltage U_N	Nominal current I_N	Cross section AWG	Cross section mm^2
Output	-	5 A	-	-
Input	-	0.02 A	-	-

 cUL Recognized Approval ID: FILE E 238705				
	Nominal voltage U_N	Nominal current I_N	Cross section AWG	Cross section mm^2
Output	-	5 A	-	-
Input	-	0.02 A	-	-

 UL Recognized Approval ID: FILE E 238705				
	Nominal voltage U_N	Nominal current I_N	Cross section AWG	Cross section mm^2
Output	-	5 A	-	-
Input	-	0.02 A	-	-

 CSAus Approval ID: 108860_0_000				
	Nominal voltage U_N	Nominal current I_N	Cross section AWG	Cross section mm^2
Output	-	5 A	-	-
Input	-	0.02 A	-	-

cULus Recognized

cCSAus

2908891

<https://www.phoenixcontact.com/us/products/2908891>

Classifications

ECLASS

ECLASS-11.0	27141152
ECLASS-12.0	27141152
ECLASS-13.0	27141152

ETIM

ETIM 8.0	EC002780
----------	----------

UNSPSC

UNSPSC 21.0	39121400
-------------	----------

FLX-D37F/16RSC/24DC/DO/TDC3K - Active module



2908891

<https://www.phoenixcontact.com/us/products/2908891>

Environmental product compliance

REACH SVHC

Lead 7439-92-1

FLX-D37F/16RSC/24DC/DO/TDC3K - Active module



2908891

<https://www.phoenixcontact.com/us/products/2908891>

Accessories

CAB-DSUB37M/OE/22/S/ 1M - Cable

2909622

<https://www.phoenixcontact.com/us/products/2909622>



Assembled shielded round cable; connection 1: Single wires (37-position) (The wires are marked and fitted with ferrules); connection 2: D-SUB pin strip (1x 37-position); cable length: 1 m

CAB-DSUB37M/OE/22/S/ 3M - Cable

2909623

<https://www.phoenixcontact.com/us/products/2909623>



Assembled shielded round cable; connection 1: Single wires (37-position) (The wires are marked and fitted with ferrules); connection 2: D-SUB pin strip (1x 37-position); cable length: 3 m

FLX-D37F/16RSC/24DC/DO/TDC3K - Active module



2908891

<https://www.phoenixcontact.com/us/products/2908891>

CAB-DSUB37M/OE/22/S/ 5M - Cable

2909624

<https://www.phoenixcontact.com/us/products/2909624>



Assembled shielded round cable; connection 1: Single wires (37-position) (The wires are marked and fitted with ferrules); connection 2: D-SUB pin strip (1x 37-position); cable length: 5 m

CAB-DSUB37M/OE/22/S/10M - Cable

2909625

<https://www.phoenixcontact.com/us/products/2909625>



Assembled shielded round cable; connection 1: Single wires (37-position) (The wires are marked and fitted with ferrules); connection 2: D-SUB pin strip (1x 37-position); cable length: 10 m

FLX-D37F/16RSC/24DC/DO/TDC3K - Active module



2908891

<https://www.phoenixcontact.com/us/products/2908891>

CAB-DSUB37M/OE/22/S/15M - Cable

2909626

<https://www.phoenixcontact.com/us/products/2909626>



Assembled shielded round cable; connection 1: Single wires (37-position) (The wires are marked and fitted with ferrules); connection 2: D-SUB pin strip (1x 37-position); cable length: 15 m

CAB-DSUB37M/OE/22/S/30M - Cable

2909627

<https://www.phoenixcontact.com/us/products/2909627>



Assembled shielded round cable; connection 1: Single wires (37-position) (The wires are marked and fitted with ferrules); connection 2: D-SUB pin strip (1x 37-position); cable length: 30 m

FLX-D37F/16RSC/24DC/DO/TDC3K - Active module



2908891

<https://www.phoenixcontact.com/us/products/2908891>

CAB-DSUB37M/OE/22/TP/S/ 1M - Cable

2909723

<https://www.phoenixcontact.com/us/products/2909723>



Assembled shielded round cable; connection 1: Twisted pair (37-position) (The wires are marked and fitted with ferrules); connection 2: D-SUB pin strip (1x 37-position); cable length: 1 m

CAB-DSUB37M/OE/22/TP/S/ 3M - Cable

2909724

<https://www.phoenixcontact.com/us/products/2909724>



Assembled shielded round cable; connection 1: Twisted pair (37-position) (The wires are marked and fitted with ferrules); connection 2: D-SUB pin strip (1x 37-position); cable length: 3 m

FLX-D37F/16RSC/24DC/DO/TDC3K - Active module



2908891

<https://www.phoenixcontact.com/us/products/2908891>

CAB-DSUB37M/OE/22/TP/S/ 5M - Cable

2909725

<https://www.phoenixcontact.com/us/products/2909725>



Assembled shielded round cable; connection 1: Twisted pair (37-position) (The wires are marked and fitted with ferrules); connection 2: D-SUB pin strip (1x 37-position); cable length: 5 m

CAB-DSUB37M/OE/22/TP/S/10M - Cable

2909726

<https://www.phoenixcontact.com/us/products/2909726>



Assembled shielded round cable; connection 1: Twisted pair (37-position) (The wires are marked and fitted with ferrules); connection 2: D-SUB pin strip (1x 37-position); cable length: 10 m

FLX-D37F/16RSC/24DC/DO/TDC3K - Active module



2908891

<https://www.phoenixcontact.com/us/products/2908891>

CAB-DSUB37M/OE/22/TP/S/15M - Cable

2909728

<https://www.phoenixcontact.com/us/products/2909728>



Assembled shielded round cable; connection 1: Twisted pair (37-position) (The wires are marked and fitted with ferrules); connection 2: D-SUB pin strip (1x 37-position); cable length: 15 m

CAB-DSUB37M/OE/22/TP/S/30M - Cable

2909729

<https://www.phoenixcontact.com/us/products/2909729>



Assembled shielded round cable; connection 1: Twisted pair (37-position) (The wires are marked and fitted with ferrules); connection 2: D-SUB pin strip (1x 37-position); cable length: 30 m

FLX-D37F/16RSC/24DC/DO/TDC3K - Active module



2908891

<https://www.phoenixcontact.com/us/products/2908891>

REL-MR- 24DC/21HC - Single relay

2961312

<https://www.phoenixcontact.com/us/products/2961312>



Plug-in miniature power relay, with power contact for high continuous currents, 1 changeover contact, input voltage 24 V DC

Phoenix Contact 2023 © - all rights reserved

<https://www.phoenixcontact.com>

Phoenix Contact USA
586 Fulling Mill Road
Middletown, PA 17057, United States
(+717) 944-1300
info@phoenixcon.com