

1. Scope of Application

These specifications apply to chip type LED lamp, CITELED, model CL-482S-TR2-CD-TS.

2. Part code

Reference

CL-482S-TR2-C D-TS

Series _____

482S : Mono-color
Ultra small, thin, sideways
light emission type

Lighting color _____

TR2 : Top high brightness red

Color of lens _____

C : colored

Diffusion _____

D : Diffused

Shipping mode _____

Non-coded: Bulk
TS: Taping (standard)

| | | | | | | | |
|------|------|-------------|----------|---------|-------|------------|------------------------------|
| | | | Approved | Checked | Drawn | Symbol | CITELED |
| | | | | | | Name | CL-482S-TR2 |
| | | | | | | Drawing No | |
| Mark | Date | Description | | | | Appro. | CITIZEN ELECTRONICS CO.,LTD. |

3. Outline drawing

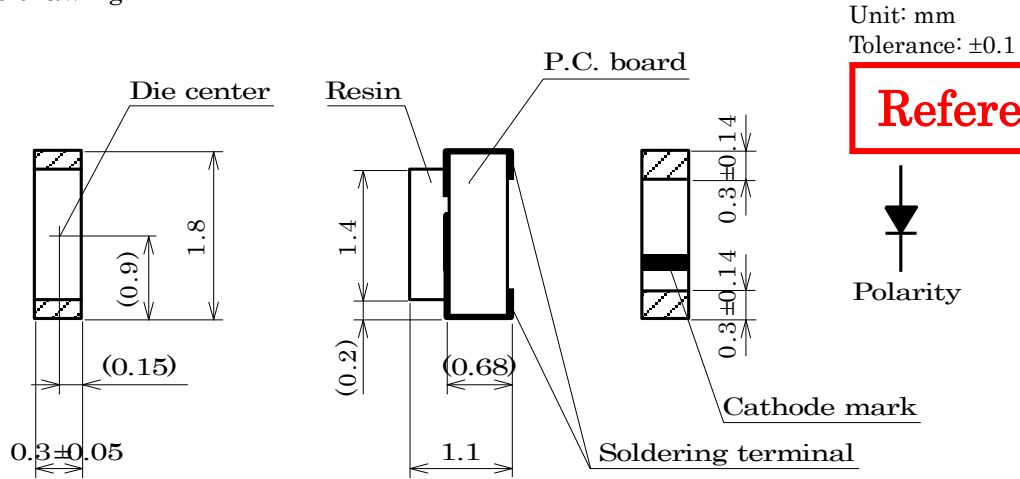

4. Performance

(1) Absolute Maximum Rating (Ta=25°C)

| Parameter | Symbol | Rating Value | Unit |
|-------------------------|--------|--------------|------|
| Power Dissipation | Pd | 58 | mW |
| Forward Current | IF | 30 | mA |
| Forward Pulse Current * | IFP | 100 * | mA |
| Reverse Voltage | VR | 4 | V |
| Operating Temperature | Top | -25 ~ +80 | °C |
| Storage Temperature | Tst | -30 ~ +85 | °C |

* Duty ≤ 1/10, Pulse width ≤ 0.1 msec

(2) Electro-optical Characteristic (Ta=25°C)

| Parameter | Symbol | Condition | MIN | TYP | MAX | Unit |
|----------------------|--------|-----------|-----|-----|------|------|
| Forward Voltage | VF | IF=20mA | — | 2.1 | 2.68 | V |
| Reverse Current | IR | VR=4V | — | — | 100 | μA |
| Luminous Intensity * | IV | IF=20mA | 23 | 80 | — | mcd |
| Dominant Wavelength | λd | IF=20mA | 624 | 630 | 640 | nm |

* In accordance with NIST standard

- Note 1) The tolerance of Forward Voltage measurement is ±3% at our tester.
 Note 2) The tolerance of Luminous Intensity measurement is ±10% at our tester.
 Note 3) For handling, please apply CMOS LSI or equivalent to prevent any electrostatic effect.
 Note 4) Please be aware that the above electro-optical characteristics are guaranteed when applying the current values shown in the table.
 Please consult us when this product is used under any other conditions.

| | | | | | | | |
|------|------|-------------|----------|------------------------------|-------|------------|-------------|
| | | | Approved | Checked | Drawn | Symbol | CITELED |
| | | | | | | Name | CL-482S-TR2 |
| | | | | | | Drawing No | |
| Mark | Date | Description | Appro. | CITIZEN ELECTRONICS CO.,LTD. | | | |

Reference

5. Characteristic

IF-VF Characteristics

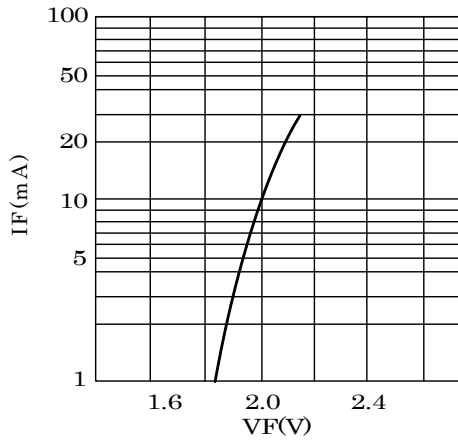

VF-Ta Characteristics

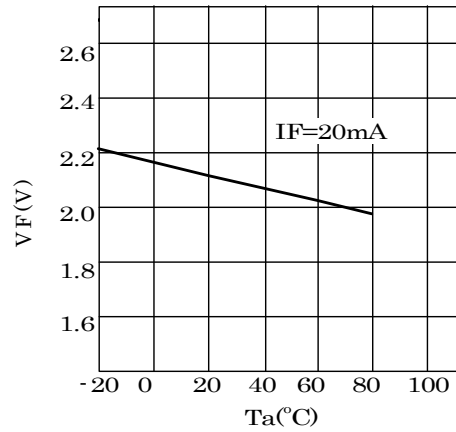

IV-IF Characteristics

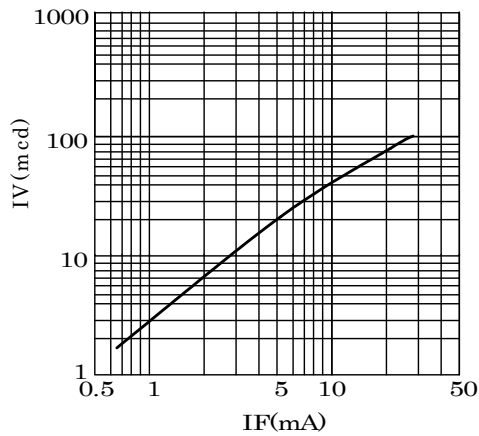

IV-Ta Characteristics

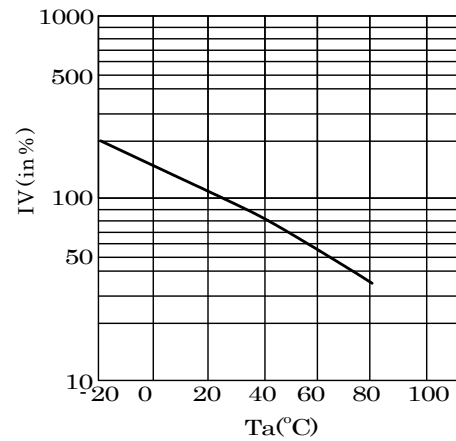

IF Max-Ta Characteristics

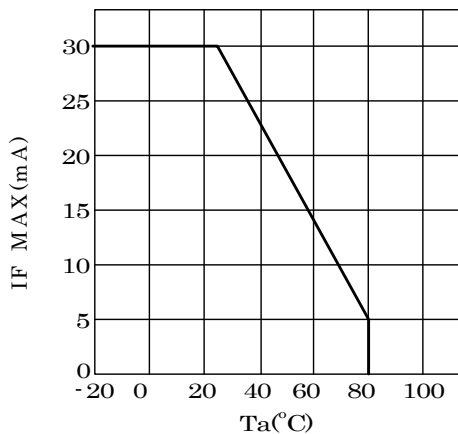

Directive Characteristics

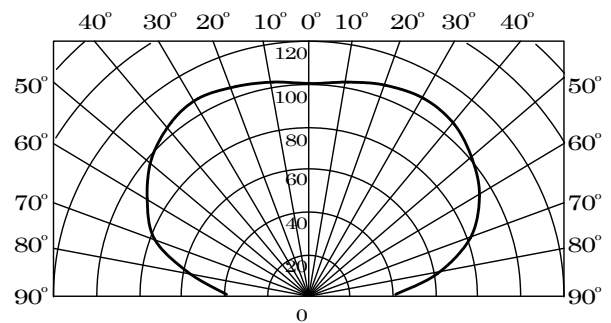

| | | | | | | | | |
|------|------|-------------|--------|------------------------------|---------|-------|------------|-------------|
| | | | | Approved | Checked | Drawn | Symbol | CITELED |
| | | | | | | | Name | CL-482S-TR2 |
| | | | | | | | Drawing No | |
| Mark | Date | Description | Appro. | CITIZEN ELECTRONICS CO.,LTD. | | | | |

6. Reliability

Reference

(1) Details of the tests

| Test Item | Test Condition |
|-----------------------------------|--|
| Life Test in Continuous Operation | $25 \pm 3^{\circ}\text{C}$, $I_F = 30 \text{ mA} \times 500^{+24}_{-12}$ hours |
| Low Temperature Storage Test | $-30^{+3}_{-3} \text{ }^{\circ}\text{C} \times 500^{+24}_{-12}$ hours |
| High Temperature Storage Test | $85^{+5}_{-3} \text{ }^{\circ}\text{C} \times 500^{+24}_{-12}$ hours |
| Moisture-proof Test | $60 \pm 2^{\circ}\text{C}$, $90 \pm 5\% \text{RH}$ for 500^{+24}_{-12} hours |
| Thermal Shock Test | $-30^{\circ}\text{C} \times 30 \text{ minutes} - 85^{\circ}\text{C} \times 30 \text{ minutes}$, 5-cycle |
| Solder Heat Resistance Test | Recommended temperature profile (reflow soldering) $\times 2$, (2 nd test must be started after the samples are stabilized thermally.) |

(2) Judgment Criteria of Failure for Reliability Test

| Measuring Item | Symbol | Measuring Condition | Judgement Criteria for Failure |
|--------------------|--------|-----------------------|--------------------------------|
| Forward Voltage | V_F | $I_F = 20 \text{ mA}$ | $>U \times 1.2$ |
| Reverse Current | I_R | $V_R = 4 \text{ V}$ | $>U \times 2$ |
| Luminous Intensity | I_V | $I_F = 20 \text{ mA}$ | $<S \times 0.5$ |

U means the upper limit of the specified characteristics. S means the initial value.

Note: Measurement shall be taken between 2 hours and 24 hours, having returned the test pieces to the normal ambient conditions after the completion of each test.

| | | | | | | | |
|------|------|-------------|----------|------------------------------|-------|------------|-------------|
| | | | Approved | Checked | Drawn | Symbol | CITELED |
| | | | | | | Name | CL-482S-TR2 |
| | | | | | | Drawing No | |
| Mark | Date | Description | Appro. | CITIZEN ELECTRONICS CO.,LTD. | | | |

Reference

7. Taping Specifications (in accordance with JIS standard)

(1) Shape and Dimensions of Reel

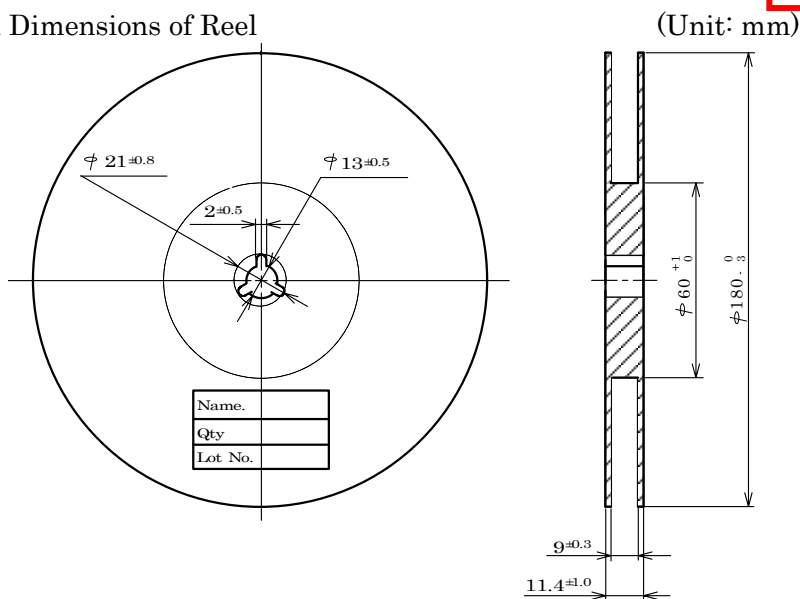

(2) Dimensions of Tape

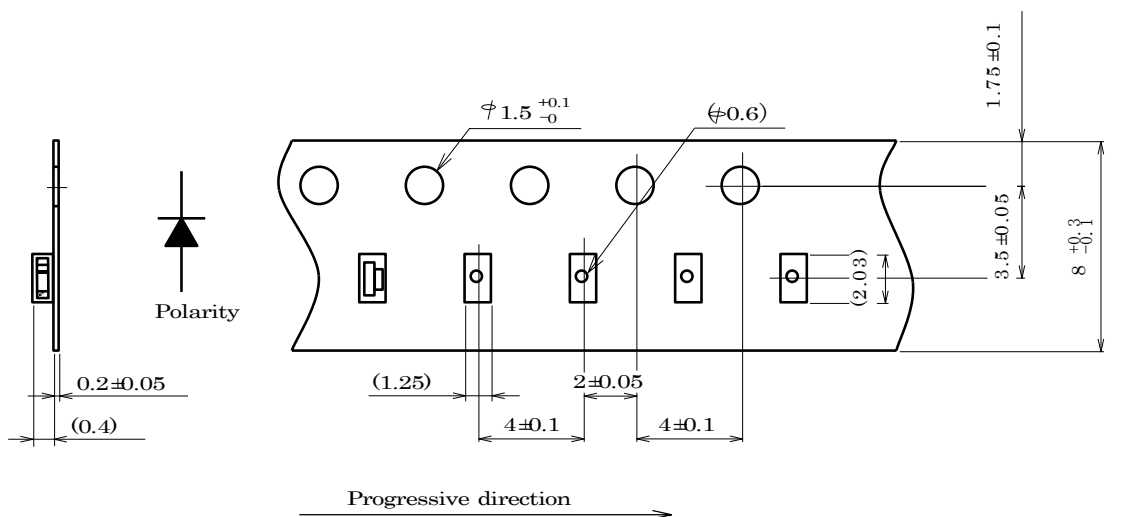

(3) Configuration of Tape

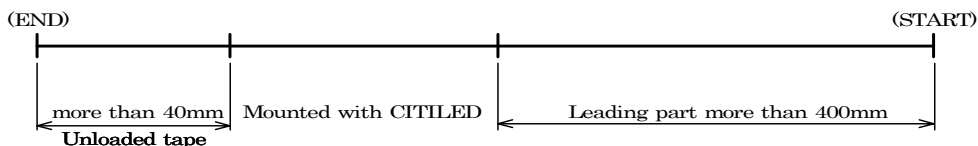

(4) Quantity: 5,000pcs/reel

(Please note that the shipping quantity of this product may be less than 5000 pieces per reel (minimum quantity: 1000 pieces) depending on the shipping quantity, shipping delivery date and other conditions. However, in this case, we will announce to you in advance.)

| | | | | | | | |
|------|------|-------------|----------|------------------------------|-------|------------|---------|
| | | | Approved | Checked | Drawn | Symbol | CITELED |
| | | | | | | Name | CL-482S |
| | | | | | | Drawing No | |
| Mark | Date | Description | Appro. | CITIZEN ELECTRONICS CO.,LTD. | | | |

Reference

8. Packing Specifications

8-1. Moisture-proof Packing

To prevent moisture absorption during transportation and storage, reels are packed in aluminum envelopes which contain a desiccant with a humidity indicator.

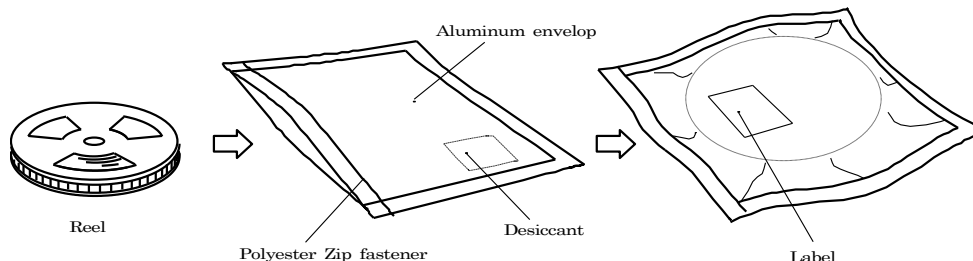

8-2. Storage

To prevent moisture absorption, it is strongly recommended that reels (in bulk or taped) should be stored in the dry box (or the desiccator) with a desiccant as the appropriate storage place. If not, the following is recommended.

Temperature: 5 ~ 30 °C
 Humidity: 60%RH max.

The devices should be mounted as soon as possible after unpacking. If you store the unpacked reels, please store them in the dry box or seal them into the envelop again.

8-3. Baking

If the devices have been stored over 6 months or unpacked over 7 days, it should be baked under the following conditions.

Baking conditions: 60°C × 12 hours or more (reeled one)
 100°C × 45 minutes or more (loose one)

| | | | | | | | |
|------|------|-------------|----------|------------------------------|-------|------------|---------|
| | | | Approved | Checked | Drawn | Symbol | CITELED |
| | | | | | | Name | CL-482 |
| | | | | | | Drawing No | |
| Mark | Date | Description | Appro. | CITIZEN ELECTRONICS CO.,LTD. | | | |

9. Precautions

Reference

9-1. Soldering

(1) Manual soldering

- 1) Solder of 96.5Sn 3Ag 0.5Cu is recommended.
- 2) Before soldering every time, make baking to units. By manual soldering, it is the possibility of crack due to the moisture absorption in the resin portion.
- 3) Use a soldering iron of 25W or smaller. Adjust the temperature of the soldering iron below 350°C.
- 4) Force or stress must not be applied to the resin portion while soldering.
- 5) Finish soldering within 3 seconds.
- 6) Handle the devices only after temperature is cooled down.

(3) Lead free soldering

- 1) Following soldering paste is recommended
 Melting temperature: 216 ~ 220°C.
 Composition: 96.5Sn 3Ag 0.5Cu
- 2) The temperature profile at the top surface of the parts is recommended as shown below.
- 3) It is requested that products should be handled after their temperature has dropped down to the normal room temperature.

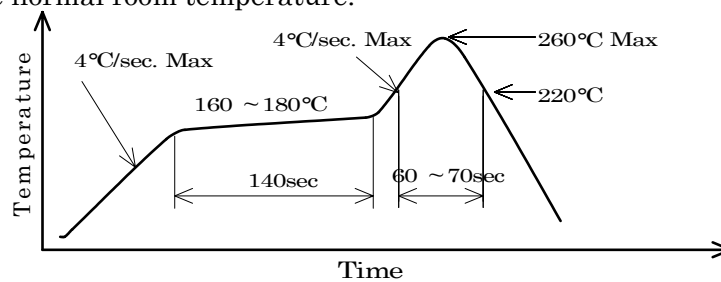

| | | | | | | | |
|------|------|-------------|----------|------------------------------|-------|------------|---------|
| | | | Approved | Checked | Drawn | Symbol | CITELED |
| | | | | | | Name | CL-482 |
| | | | | | | Drawing No | |
| Mark | Date | Description | Appro. | CITIZEN ELECTRONICS CO.,LTD. | | | |

Reference

9-2. Washing

- (1) When washing after soldering is needed, following conditions are requested.
 - a) Washing solvent: Alcohol
 - b) Temperature, time: 50°C or less × 30 seconds max.
or 30°C or less × 3 minutes max.
 - c) Ultrasonic washing: 300W or less

9-3. Other directions

- (1) It is requested to avoid any stress added to the resin portion while it is heated.
- (2) It is requested to avoid any friction by sharp metal nail etc. to the resin portion.

10. Designing precautions

- (1) The current limiting resistor should be placed in the circuit so that is driven within its rating. Also avoid reverse voltage (over-current) applied instantaneously when ON or OFF.
- (2) When pulse driving current is applied, average current consumption should be within the rating. Also avoid reverse voltage applied when put off.
- (3) Recommended soldering pattern

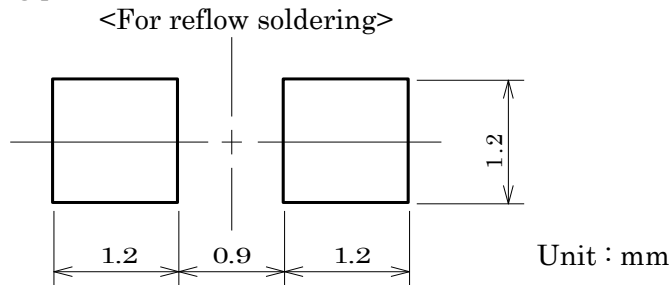

The above dimensions are not the one which guarantee the performance of mountability.

The use of the above pattern is recommended to use after deep study at your site.

- (4) When assembling the circuit board into the finished products, care must be taken to avoid the component parts from touching other parts.
- (5) When using multiple LEDs, it is required to connect a current limiting resistor on each path which the current flows to the LEDs.

(ex-1)

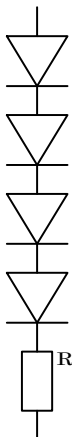

(ex-2)

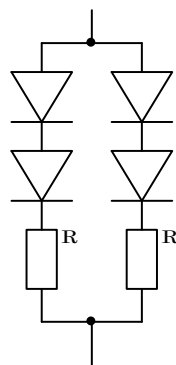

(ex-3)

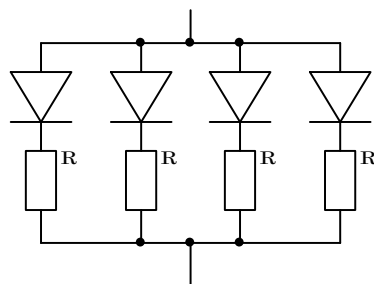

| | | | | | | | | |
|------|------|-------------|--------|------------------------------|---------|-------|------------|---------|
| | | | | Approved | Checked | Drawn | Symbol | CITELED |
| | | | | | | | Name | CL-482 |
| | | | | | | | Drawing No | |
| Mark | Date | Description | Appro. | CITIZEN ELECTRONICS CO.,LTD. | | | | |