

REVISIONS

P	LTR	DESCRIPTION	DATE	DWN	APVD
	A	INITIAL RELEASE	19JUN2020	J.G	I.Y
	A1	ECR-20-010349	26JUL2020	J.G	I.Y
	A2	ECN-21-113425	17AUG2021	J.G	Z.Z

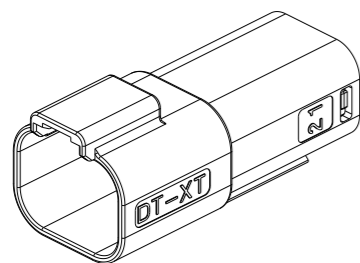

4CCT RECEPTACLE CONNECTOR WITHOUT HEATSHRINK HOUSING

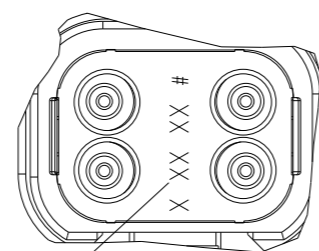

DETAIL A SCALE 2:1

4 DATE CODE: X XX XX  
 X- DAY: 1- 7  
 XX- WEEK: 01 - 52  
 XX- YEAR: 00 - 99

#- MACHINE NO. 1

EXAMPLE: 11315 = DAY 1, WEEK 13, YEAR 15  
i.e. 23rd OF MARCH 2015

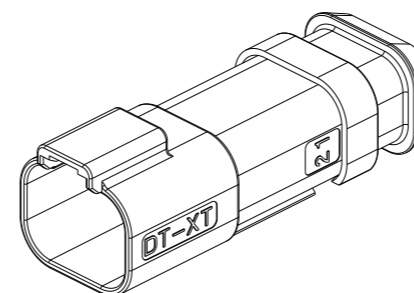

4CCT RECEPTACLE CONNECTOR WITH HEATSHRINK HOUSING ULTRASONICALLY WELDED IN PLACE

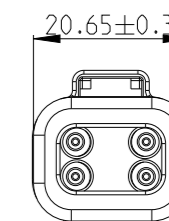
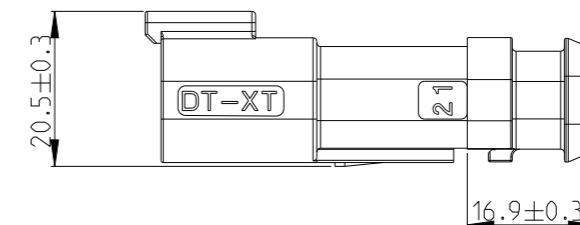
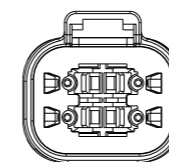
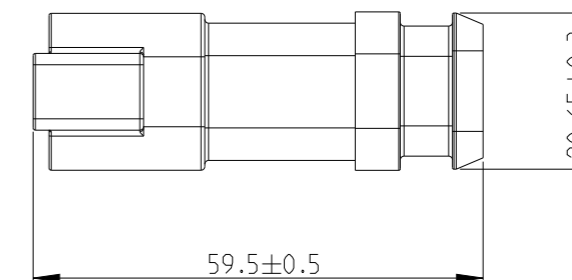
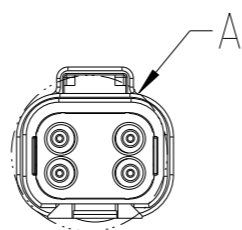
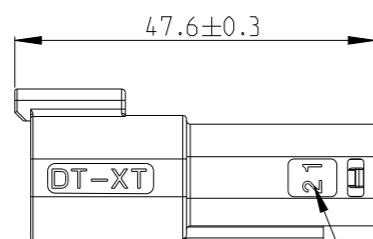
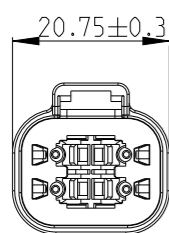

1. THIS RECEP MATES WITH PLUG ASSEMBLY PN X-2600031-X, WEDGE LOCK PN W4PX.

2. MATERIALS

- RECEPTACLE HOUSING: NYLON GF30, SEE PN TABLE FOR COLOUR
- BACK SEAL: SILICONE RUBBER
- BACK COVER: NYLON GF30, BLACK
- HEATSHRINK HOUSING: NYLON GF30, BLACK

3 CIRCUIT IDENTIFICATION

4 DATE CODE DESCRIPTION

5. JACKET RANGE LARGE = Ø2.23MM TO 3.68MM (SEAL COLOUR: LIGHT BLUE)  
JACKET RANGE SMALL = Ø1.20MM TO 3.05MM (SEAL COLOUR: BURNT ORANGE)

6. SEE SHEET 2 FOR FINAL PART NUMBER

THIS DRAWING IS A CONTROLLED DOCUMENT.

DIMENSIONS:	TOLERANCES UNLESS OTHERWISE SPECIFIED:
mm	
	0 PLC ±
	1 PLC ±
	2 PLC ±
	3 PLC ±
	4 PLC ±
	ANGLES ±
MATERIAL -	FINISH -

DWN	J.GU	19JUN2020
CHK	E. JIANG	19JUN2020
APVD	I.YIN	19JUN2020
PRODUCT SPEC	108-160026	
APPLICATION SPEC	114-160017	
WEIGHT	-	

TE Connectivity		NAME		RESTRICTED TO
		4CCT DT-XT CONNECTOR RECEPTACLE ASSEMBLY		
SIZE	CAGE CODE	DRAWING NO		
A3	00779	C-2600030		
CUSTOMER DRAWING;RESTRICTED CUSTOMER		SCALE	SHEET	REV
		1:1	1 OF 2	A2

THIS DRAWING IS UNPUBLISHED.

RELEASED FOR PUBLICATION

20

REVISIONS

© COPYRIGHT 2020 TE Connectivity. All Rights Reserved.

ALL RIGHTS RESERVED.

P	LTR	DESCRIPTION	DATE	DWN	APVD
		SEE SHEET 1			

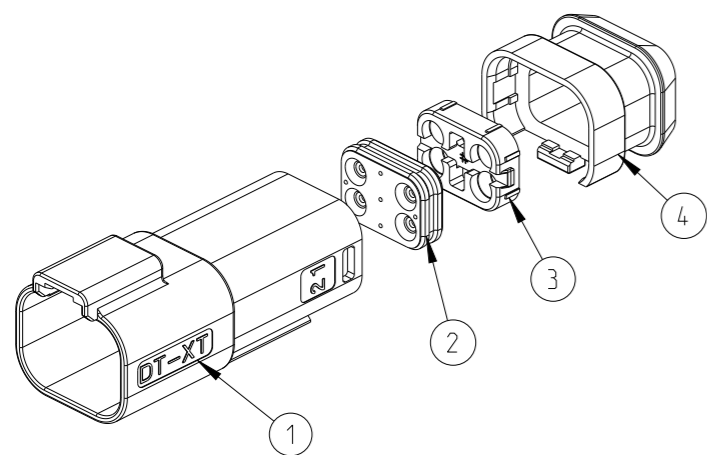

TE PN	ALIAS PN	REVISION OF EACH ASSY NO.	WEIGHT OF EACH ASSY(g)	COLOR	BLACK	GERY	GREEN	BLUE	YELLOW	WHITE	BROWN	ORANGE	RED	BURNT ORANGE	LIGHT BLUE	BLACK	BLACK	
3--6	934443609	-	10.02		-	-	-	-	-	-	-	-	1	-	1	1	1	
3--5	934443608	-	10.02		-	-	-	-	-	-	-	1	-	-	1	1	1	
3--4	934443607	-	10.02		-	-	-	-	-	1	-	-	-	-	1	1	1	
3--3	934443606	-	10.02		-	-	-	-	-	1	-	-	-	-	1	1	1	
3--2	934443605	-	10.02		-	-	-	-	1	-	-	-	-	-	1	1	1	
3--1	934443604	-	10.02		-	-	-	1	-	-	-	-	-	-	1	1	1	
3--0	934443603	-	10.02		-	-	-	-	-	-	-	-	-	-	1	1	1	
2--9	934443602	-	10.02		-	1	-	-	-	-	-	-	-	-	1	1	1	
2--8	934443601	-	10.02		-	-	-	-	-	-	-	-	-	-	1	1	1	
2--7	934443509	-	10.02		1	-	-	-	-	-	-	-	-	-	1	1	1	
2--6	934443508	-	10.02		-	-	-	-	-	-	-	1	1	-	1	1	1	
2--5	934443507	-	10.02		-	-	-	-	-	-	1	-	-	1	-	1	1	
2--4	934443506	-	10.02		-	-	-	-	-	1	-	-	-	1	-	1	1	
2--3	934443505	-	10.02		-	-	-	-	1	-	-	-	-	1	-	1	1	
2--2	934443504	-	10.02		-	-	-	1	-	-	-	-	-	1	-	1	1	
2--1	934443503	-	10.02		-	-	1	-	-	-	-	-	-	1	-	1	1	
2--0	934443502	-	10.02		-	1	-	-	-	-	-	-	-	1	-	1	1	
1--9	934443501	-	10.02		1	-	-	-	-	-	-	-	-	1	-	1	1	
1--8	934443209	-	7.61		-	-	-	-	-	-	-	1	-	1	1	1	-	
1--7	934443208	-	7.61		-	-	-	-	-	-	1	-	-	1	1	1	-	
1--6	934443207	-	7.61		-	-	-	-	-	1	-	-	-	1	1	1	-	
1--5	934443206	-	7.61		-	-	-	-	1	-	-	-	-	1	1	1	-	
1--4	934443205	-	7.61		-	-	-	1	-	-	-	-	-	1	1	1	-	
1--3	934443204	-	7.61		-	-	-	1	-	-	-	-	-	1	1	1	-	
1--2	934443203	-	7.61		-	-	1	-	-	-	-	-	-	1	1	1	-	
1--1	934443202	-	7.61		-	1	-	-	-	-	-	-	-	1	1	1	-	
1--0	934443201	-	7.61		1	-	-	-	-	-	-	-	-	1	1	1	-	
-9	934443109	-	7.61		-	-	-	-	-	-	-	1	1	-	1	1	-	
-8	934443108	-	7.61		-	-	-	-	-	-	1	-	1	-	1	1	-	
-7	934443107	-	7.61		-	-	-	-	-	1	-	-	1	-	1	1	-	
-6	934443106	-	7.61		-	-	-	-	1	-	-	-	1	-	1	1	-	
-5	934443105	-	7.61		-	-	-	-	1	-	-	-	1	-	1	1	-	
-4	934443104	-	7.61		-	-	-	1	-	-	-	-	1	-	1	1	-	
-3	934443103	-	7.61		-	-	1	-	-	-	-	-	1	-	1	1	-	
-2	934443102	-	7.61		-	1	-	-	-	-	-	-	1	-	1	1	-	
-1	934443101	-	7.61		1	-	-	-	-	-	-	-	1	-	1	1	-	
				DESCRIPTION	RECEPTACLE HOUSING										BACK SEAL SMALL	BACK SEAL LARGE	BACK COVER	HEATSHRINK HOUSING
				ITEM NO	1										2		3	4

THIS DRAWING IS A CONTROLLED DOCUMENT.

DIMENSIONS: mm

TOLERANCES UNLESS OTHERWISE SPECIFIED:

0 PLC	±
1 PLC	±
2 PLC	±
3 PLC	±
4 PLC	±
ANGLES	±
FINISH	-

MATERIAL: -

APVD: J.GU 19 JUN 2020

CHK: E. JIANG 19 JUN 2020

APVD: L. YIN 19 JUN 2020

PRODUCT SPEC: 108-160026

APPLICATION SPEC: 114-160017

WEIGHT: -

NAME: 4CCT DT-XT CONNECTOR RECEPTACLE ASSEMBLY

SIZE: A3 CAGE CODE: 00779 DRAWING NO: C=2600030 RESTRICTED TO: -

CUSTOMER DRAWING; RESTRICTED CUSTOMER SCALE: 1:1 SHEET: 2 OF 2 REV: A2

