



MS5806-02BA

Miniature Altimeter Module

SPECIFICATIONS

- ◆ High resolution module, 20cm
- ◆ Fast conversion down to 1 ms
- ◆ Low power, 1 μ A (standby < 0.15 μ A)
- ◆ Integrated digital pressure sensor (24 bit $\Delta\Sigma$ ADC)
- ◆ Supply voltage 1.8 to 3.6 V
- ◆ Operating range: 300 to 1100 mbar, -40 to +85 °C
- ◆ Extended Pressure Range: 10 to 2000mbar
- ◆ I²C or SPI interface (Mode 0, 3)
- ◆ No external components (Internal oscillator)
- ◆ Excellent long term stability
- ◆ Hermetically sealable for outdoor devices

The MS5806-02BA is a new generation of high resolution altimeter sensors from MEAS Switzerland with SPI and I²C bus interface. It is optimized for altimeters and variometers with an altitude resolution of 20cm. The sensor module includes a high linearity pressure sensor and an ultra low power 24 bit $\Delta\Sigma$ ADC with internal factory calibrated coefficients. It provides a precise digital 24 Bit pressure and temperature value and different operation modes that allow the user to optimize for conversion speed and current consumption. A high resolution temperature output allows the implementation of an altimeter/thermometer function without any additional sensor. The MS5806-02BA can be interfaced to virtually any microcontroller. The communication protocol is simple, without the need of programming internal registers in the device. The gel protection and antimagnetic stainless steel cap allows the use in 100m water resistant altimeter/compass watches. This new sensor module generation is based on leading MEMS technology and latest benefits from MEAS Switzerland proven experience and know-how in high volume manufacturing of altimeter modules, which has been widely used for over a decade. The sensing principle employed leads to very low hysteresis and high stability of both pressure and temperature signal.

FEATURES

FIELD OF APPLICATION

- ◆ Mobile altimeter / barometer systems
- ◆ Bike computers
- ◆ Adventure or multi-mode watches
- ◆ Variometers
- ◆ Dataloggers

TECHNICAL DATA

Sensor Performances ($V_{DD} = 3\text{ V}$)				
Pressure	Min	Typ	Max	Unit
Range	10		2000	mbar
ADC	24			bit
Resolution (1)	0.13 / 0.084 / 0.054 / 0.036 / 0.024			mbar
Accuracy 25°C, 750 to 1100 mbar	-1.5		+1.5	mbar
Accuracy -20°C to + 85°C, 300 to 1100 mbar (2)	-2.5		+2.5	mbar
Response time	0.5 / 1.1 / 2.1 / 4.1 / 8.22			ms
Long term stability		+1		mbar/yr
Temperature	Min	Typ	Max	Unit
Range	-40		+85	°C
Resolution		<0.01		°C
Accuracy at 25°C	-0.8		+0.8	°C
Notes: (1) Oversampling Ratio: 256 / 512 / 1024 / 2048 / 4096				
(2) With autozero at one pressure point				

FUNCTIONAL BLOCK DIAGRAM

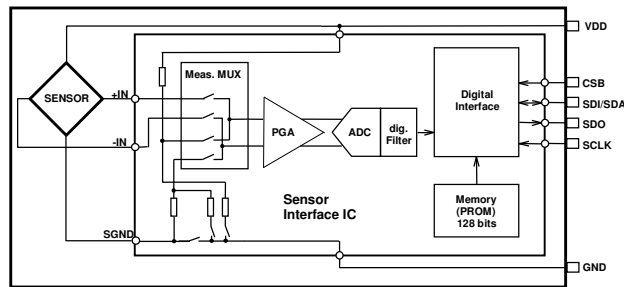

Note: the communication protocol is defined by hardware (I2c: version 52 and SPI: version 42)

PERFORMANCE SPECIFICATIONS

ABSOLUTE MAXIMUM RATINGS

Parameter	Symbol	Conditions	Min.	Typ.	Max	Unit
Supply voltage	V _{DD}		-0.3		+3.6	V
Storage temperature	T _S		-40		+85	°C
Overpressure	P _{max}	ISO 2281			10	bar
Maximum Soldering Temperature	T _{max}	40 sec max			250	°C
ESD rating		Human Body Model	-4		+4	kV
Latch up		JEDEC standard No 78	-100		+100	mA

ELECTRICAL CHARACTERISTICS

Parameter	Symbol	Conditions	Min.	Typ.	Max	Unit
Operating Supply voltage	V _{DD}		1.8	3.0	3.6	V
Operating Temperature	T		-40	+25	+85	°C
Supply current (1 sample per sec.)	I _{DD}	OSR 4096 2048 1024 512 256		12.5 6.3 3.2 1.7 0.9		µA
Peak supply current		during conversion		1.4		mA
Standby supply current		at 25°C		0.02	0.14	µA
VDD Capacitor		From VDD to GND	100			nF

ANALOG DIGITAL CONVERTER (ADC)

Parameter	Symbol	Conditions	Min.	Typ.	Max	Unit
Output Word				24		bit
Conversion time	t _c	OSR 4096 2048 1024 512 256	7.40 3.72 1.88 0.95 0.48	8.22 4.13 2.08 1.06 0.54	9.04 4.54 2.28 1.17 0.60	ms

PERFORMANCE SPECIFICATIONS (CONTINUED)

PRESSURE OUTPUT CHARACTERISTICS (V_{DD} = 3 V, T = 25°C UNLESS OTHERWISE NOTED)

Parameter	Conditions		Min.	Typ.	Max	Unit
Operating Pressure Range	P _{range}	Full Accuracy	300		1100	mbar
Extended Pressure Range	P _{ext}	Linear Range of ADC	10		2000	mbar
Absolute Accuracy, no autozero	at 25°C, 700..1100 mbar		-1.5		+1.5	mbar
	at 0..50°C, 300..1100 mbar		-2.0		+2.0	
	at -20..85°C, 300..1100 mbar		-3.5		+3.5	
Absolute Accuracy, autozero at one pressure point	at 25°C, 700..1100 mbar		-0.5		+0.5	mbar
	at 0..50°C, 300..1100 mbar		-1.0		+1.0	
	at -20..85°C, 300..1100 mbar		-2.5		+2.5	
Maximum error with supply voltage (1)	V _{DD} = 1.8 V ... 3.6 V			+/- 3		mbar
Maximum error with supply voltage compensation (1) (2)	V _{DD} = 2.2 V ... 3.0 V			+/-0.6		mbar
Long-term stability				+1		mbar/yr
Resolution RMS	OSR	4096		0.024		mbar
		2048		0.036		
		1024		0.054		
		512		0.084		
		256		0.130		

(1) With autozero at 3V point

(2) With voltage compensation for accumulator application

TEMPERATURE OUTPUT CHARACTERISTICS (V_{DD} = 3 V, T = 25°C UNLESS OTHERWISE NOTED)

Parameter	Conditions		Min.	Typ.	Max	Unit
Absolute Accuracy	700 ... 1100mbar		-0.8		+0.8	°C
	-20..85°C		-2.0		+2.0	
Maximum error with supply voltage(1)	V _{DD} = 1.8 V ... 3.6 V			+/- 0.5		°C
Resolution RMS	OSR	4096		0.002		°C
		2048		0.003		
		1024		0.005		
		512		0.008		
		256		0.012		

(1) With autozero at 3V point

PERFORMANCE SPECIFICATIONS (CONTINUED)

DIGITAL INPUTS (CSB, DIN, SCLK, SDA, SCL)

Parameter	Symbol	Conditions	Min.	Typ.	Max	Unit
Serial data clock	SCLK	SPI protocol			10	MHz
Input high voltage	V _{IH}	Pins CSB	80% V _{DD}		100% V _{DD}	V
Input low voltage	V _{IL}		0% V _{DD}		20% V _{DD}	V
Input leakage current	I _{leak25°C}	at 25°C			0.15	μA
Load capacitance	C _{IN}			8		pF

DIGITAL OUTPUTS (DOUT, SDA, SCL)

Parameter	Symbol	Conditions	Min.	Typ.	Max	Unit
Output high voltage	V _{OH}	I _{source} = 0.6 mA	80% V _{DD}		100% V _{DD}	V
Output low voltage	V _{OL}	I _{sink} = 0.6 mA	0% V _{DD}		20% V _{DD}	V
Load capacitance	C _{LOAD}			16		pF

PERFORMANCE CHARACTERISTICS

PRESSURE ERROR VS PRESSURE AND TEMPERATURE

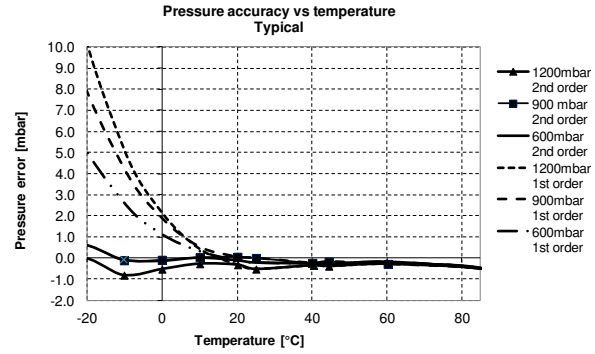
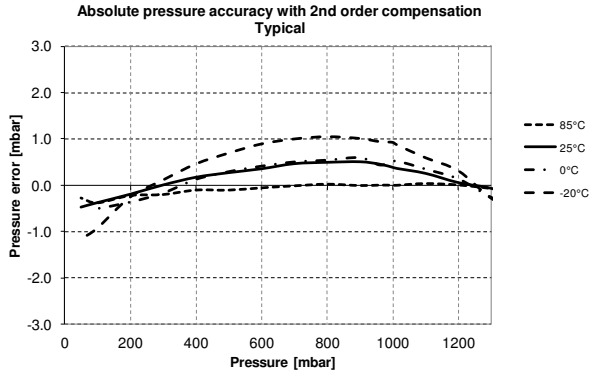

TEMPERATURE ERROR VS TEMPERATURE AND EXTENDED PRESSURE RANGE (TYPICAL ERROR)

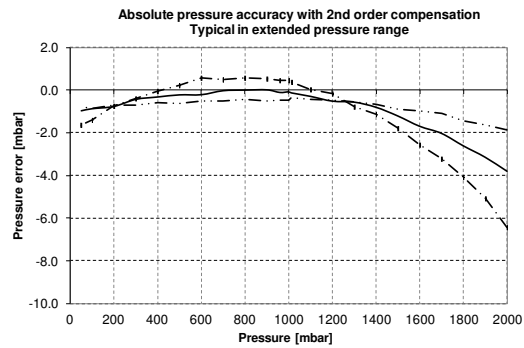
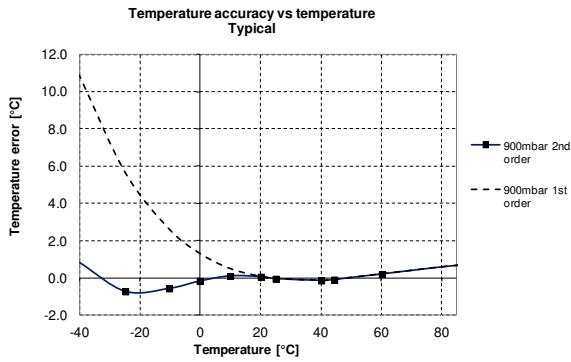

PRESSURE AND PSRR TEMPERATURE VS SUPPLY VOLTAGE

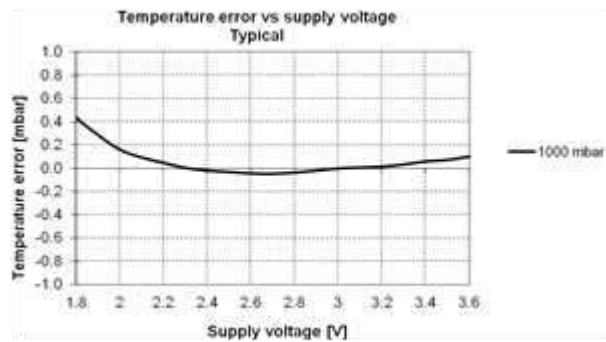
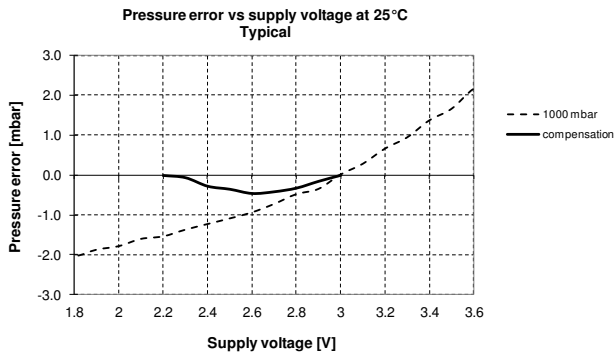

FUNCTIONAL DESCRIPTION

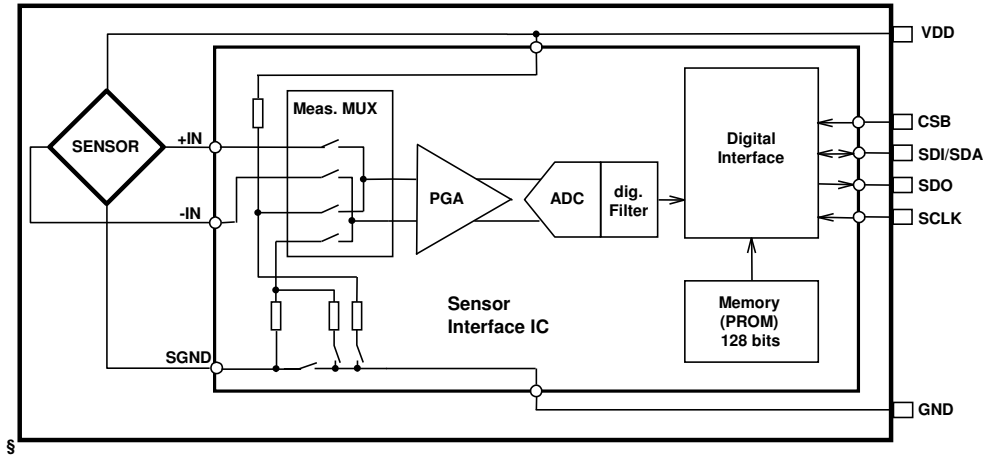

Figure 1: Block diagram of MS5806-02BA

GENERAL

The MS5806-02BA consists of a piezo-resistive sensor and a sensor interface IC. The main function of the MS5806-02BA is to convert the uncompensated analogue output voltage from the piezo-resistive pressure sensor to a 24-bit digital value, as well as providing a 24-bit digital value for the temperature of the sensor.

FACTORY CALIBRATION

Every module is individually factory calibrated at two temperatures and two pressures. As a result, 6 coefficients necessary to compensate for process variations and temperature variations are calculated and stored in the 128-bit PROM of each module. These bits (partitioned into 6 coefficients W1 to W6) must be read by the microcontroller software and used in the program converting D1 and D2 into compensated pressure and temperature values. The 2 coefficients W0 and W7 are for factory configuration and CRC.

SERIAL INTERFACE

The MS5806-02BA has built in two types of serial interfaces: SPI and I²C. The pin PS is factory connected to GND or VCC to define the Protocol Select:

Module ref	Mode	Pins used
MS5806-02BA52	I ² C	SDA, SCL, CSB
MS5806-02BA42	SPI	SDI, SDO, SCLK, CSB

SPI MODE

The external microcontroller clocks in the data through the input SCLK (Serial CLock) and SDI (Serial Data In). In the SPI mode module can accept both mode 0 and mode 3 for the clock polarity and phase. The sensor responds on the output SDO (Serial Data Out). The pin CSB (Chip Select) is used to enable/disable the interface, so that other devices can talk on the same SPI bus. The CSB pin can be pulled high after the command is sent or after the end of the command execution (for example end of conversion). The best noise performance from the module is obtained when the SPI bus is quiet and without communication to other devices during the ADC conversion in progress.

I²C MODE

The external microcontroller clocks in the data through the input SCLK (Serial CLock) and SDA (Serial DATa). The sensor responds on the same pin SDA which is bidirectional for the I²C bus interface. So this interface type uses only 2 signal lines and does not require a chip select, which can be favorable to reduce board space. In I²C-Mode the complement of the pin CSB (Chip Select) represents the LSB of the I²C address. It is possible to use two sensors with two different addresses on the I²C bus. The pin CSB shall be connected to VDD or GND (do not leave unconnected!).

Pin CSB	Address (7 bits)
High	0x76 (1110110 b)
Low	0x77 (1110111 b)

COMMANDS

The MS5806-02BA has only five basic commands:

1. Reset
2. Read PROM (128 bit of calibration words)
3. D1 conversion
4. D2 conversion
5. Read ADC result (24 bit pressure / temperature)

Bit number	Command byte								hex value
	0	1	2	3	4	5	6	7	
Bit name	PRM	COV	-	Typ	Ad2/ Os2	Ad1/ Os1	Ad0/ Os0	Stop	
Command									
Reset	0	0	0	1	1	1	1	0	0x1E
Convert D1 (OSR=256)	0	1	0	0	0	0	0	0	0x40
Convert D1 (OSR=512)	0	1	0	0	0	0	1	0	0x42
Convert D1 (OSR=1024)	0	1	0	0	0	1	0	0	0x44
Convert D1 (OSR=2048)	0	1	0	0	0	1	1	0	0x46
Convert D1 (OSR=4096)	0	1	0	0	1	0	0	0	0x48
Convert D2 (OSR=256)	0	1	0	1	0	0	0	0	0x50
Convert D2 (OSR=512)	0	1	0	1	0	0	1	0	0x52
Convert D2 (OSR=1024)	0	1	0	1	0	1	0	0	0x54
Convert D2 (OSR=2048)	0	1	0	1	0	1	1	0	0x56
Convert D2 (OSR=4096)	0	1	0	1	1	0	0	0	0x58
ADC Read	0	0	0	0	0	0	0	0	0x00
PROM Read	1	0	1	0	Ad2	Ad1	Ad0	0	0xA0 to 0xAE

Figure 2: Command structure

PRM	PROM read bit
COV	Conversion selection bit
Typ	D1 or D2 selection bit (Conversion mode)
ADx / OSx	Address PROM or OSR configuration
Stop	Stop bit

Figure 2a: Bit description

PRESSURE AND TEMPERATURE CALCULATION

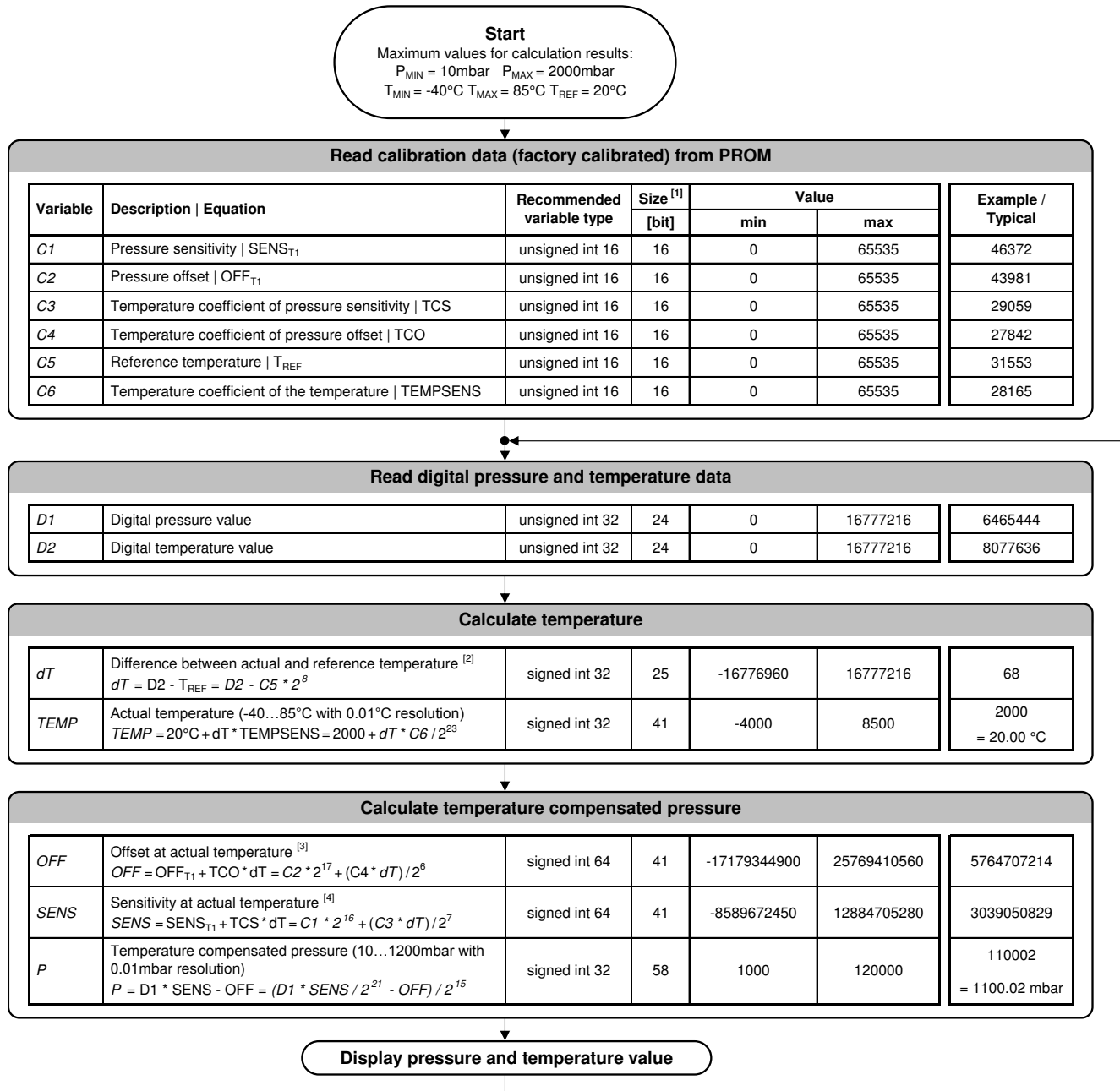

Notes

- [1] Maximal size of intermediate result during evaluation of variable
- [2] min and max have to be defined
- [3] min and max have to be defined
- [4] min and max have to be defined

Figure 3: Flow chart for pressure and temperature reading and software compensation.

SECOND ORDER TEMPERATURE COMPENSATION

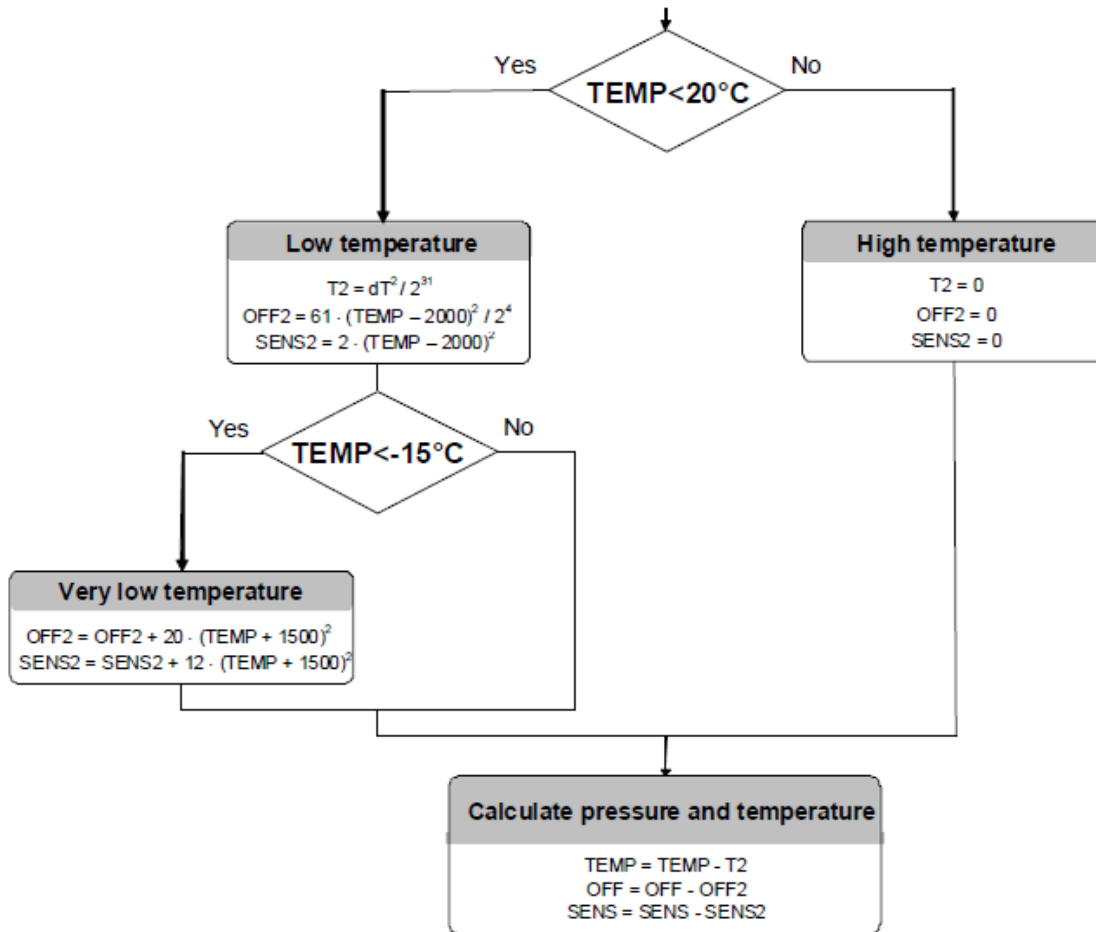

Figure 4: Flow chart for pressure and temperature to the optimum accuracy.

PRESSURE COMPENSATION WITH SUPPLY VOLTAGE

It is recommended to use this formula only in the specified voltage range. During the ADC conversion, the power supply V_{DD} must be stable.

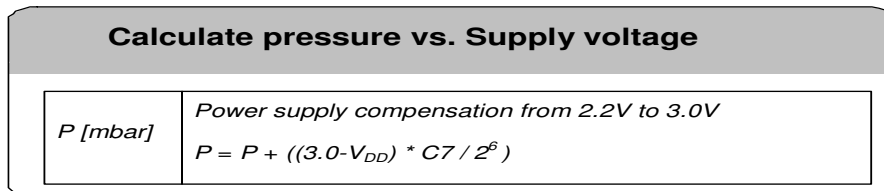

Figure 5: Flow chart for pressure compensation VS supply voltage.

SPI INTERFACE (MS5806-02BA42 ONLY)

RESET SEQUENCE

The Reset sequence shall be sent once after power-on to make sure that the calibration PROM gets loaded into the internal register. It can be also used to reset the device ROM from an unknown condition

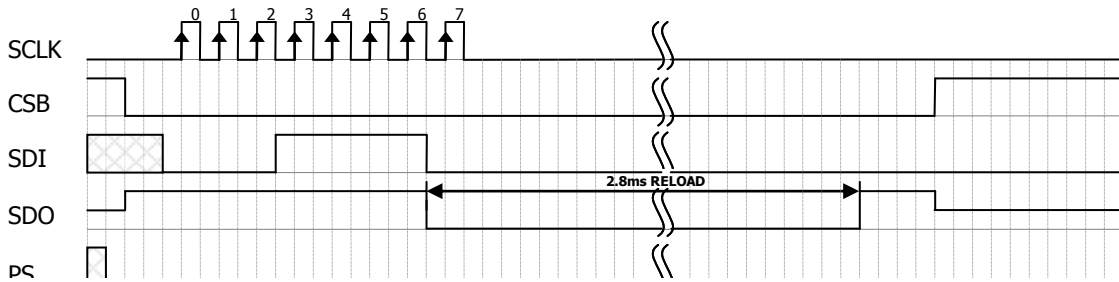

Figure 6: Reset command sequence SPI mode 0

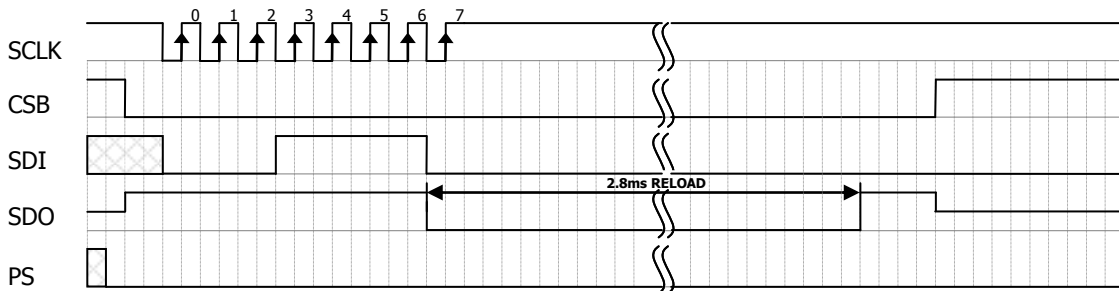

Figure 6a: Reset command sequence SPI mode 3

CONVERSION SEQUENCE

The conversion command is used to initiate uncompensated pressure (D1) or uncompensated temperature (D2) conversion. The chip select can be disabled during this time to communicate with other devices. After the conversion, using ADC read command the result is clocked out with the MSB first. If the conversion is not executed before the ADC read command, or the ADC read command is repeated, it will give 0 as the output result. If the ADC read command is sent during conversion the result will be 0, the conversion will not stop and the final result will be wrong. Conversion sequence sent during the already started conversion process will yield incorrect result as well.

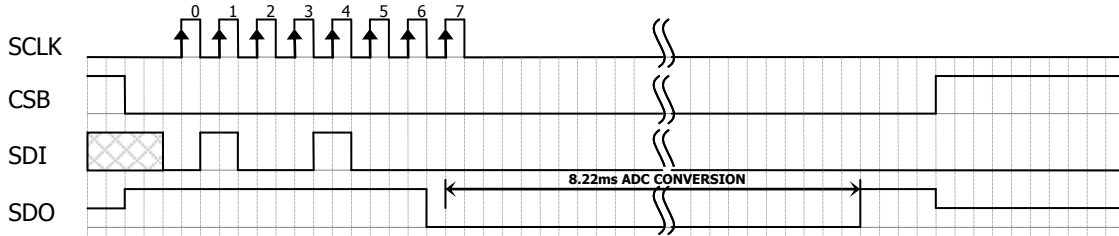

Figure 7: Conversion out sequence, Typ=d1, OSR = 4096

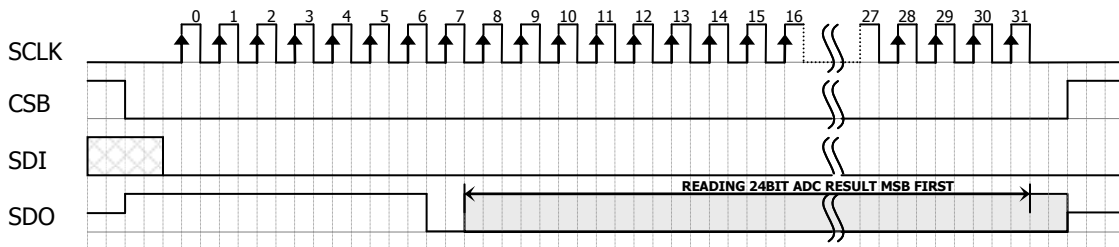

Figure 8: ADC Read sequence

PROM READ SEQUENCE

The read command for PROM shall be executed once after reset by the user to read the content of the calibration PROM and to calculate the calibration coefficients. There are in total 8 addresses resulting in a total memory of 128 bit. Address 0 contains factory data and the setup, addresses 1-6 calibration coefficients and address 7 contains the serial code and CRC. The command sequence is 8 bits long with a 16 bit result which is clocked with the MSB first.

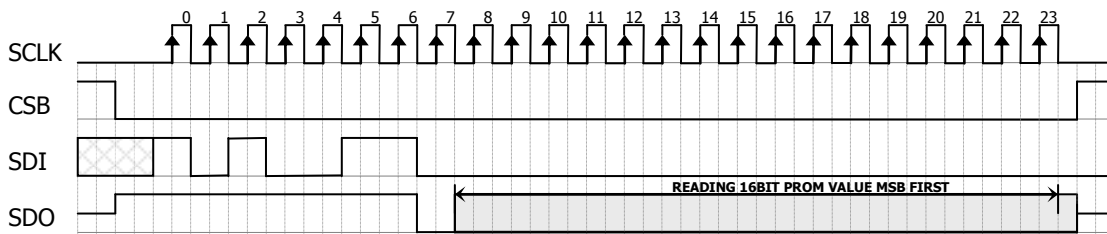

Figure 9: PROM Read sequence, address = 011 (Coefficient 3)

I²C INTERFACE (MS5806-02BA52 ONLY)

COMMANDS

Each I²C communication message starts with the start condition and it is ended with the stop condition. The MS5806-02BA address is 111011Cx, where C is the complementary value of the pin CSB. Since the IC does not have a microcontroller inside, the commands for I²C and SPI are quite similar.

RESET SEQUENCE

The reset can be sent at any time except when the power on did not work it could be possible that the acknowledge blocks the SDA. When SDA is blocked by an undefined state the only way to get the MS5806-02BA to work is to send a power on reset.

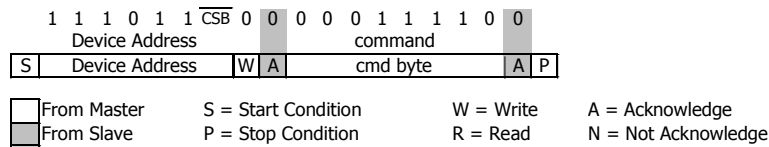

Figure 10: I²C Reset Command

CONVERSION SEQUENCE

A conversion can be started by sending the command to MS5806-02BA. When command is sent to the system it stays busy until conversion is done. When conversion is finished the data can be accessed by sending a Read command, when an acknowledge appears from the MS5806-02BA, you may then send 24 SCLK cycles to get all result bits. Every 8 bit the system waits for an acknowledge signal.

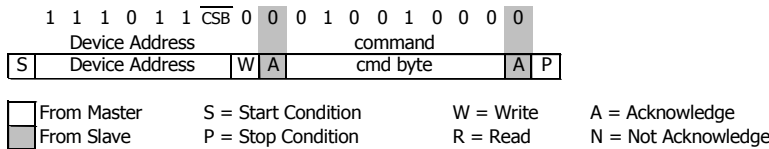

Figure 11: I²C Command to initiate a pressure conversion (OSR=4096, typ=D1)

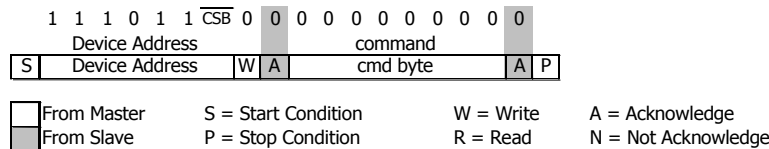

Figure 12: I²C ADC read sequence

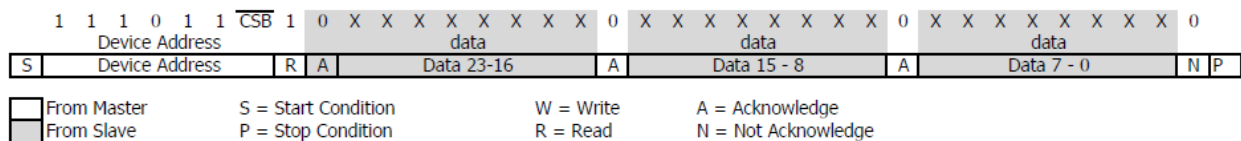

Figure 13: I²C pressure response (D1) on 24 bit from MS5806-02BA

PROM READ SEQUENCE

The PROM Read command consists of two parts. First command sets up the system into PROM read mode. The second part gets the data from the system.

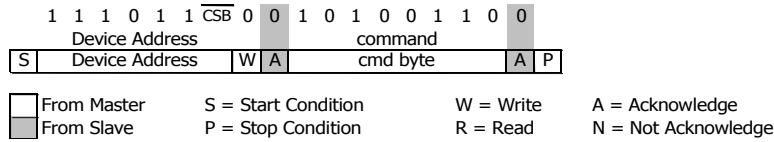

Figure 14: I²C Command to read memory address= 011 (Coefficient 3)

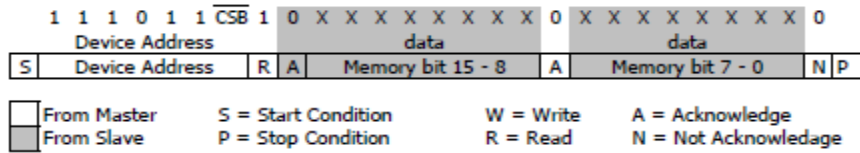

Figure 15: I²C answer from MS5806-02BA

CYCLIC REDUNDANCY CHECK (CRC)

MS5806-02BA contains a PROM memory with 128-Bit. A 4-bit CRC has been implemented to check the data validity in memory. The application note AN520 describes in detail CRC-4 code used.

A	D	D	D	D	D	D	D	D	D	D	D	D	D	D	D	D
d	B	B	B	B	B	B	B	B	B	B	B	B	B	B	B	B
d	1	1	1	1	1	1	0	9	8	7	6	5	4	3	2	1
d	5	4	3	2	1	0										0
0	16 bit reserved for manufacturer															
1	Coefficient 1 (16 bit unsigned)															
2	Coefficient 2 (16 bit unsigned)															
3	Coefficient 3 (16 bit unsigned)															
4	Coefficient 4 (16 bit unsigned)															
5	Coefficient 5 (16 bit unsigned)															
6	Coefficient 6 (16 bit unsigned)															
7	-	-	-	-	Coefficient 7 (8 bit unsigned)								CRC			

Figure 16: Memory PROM mapping

APPLICATION CIRCUIT

The MS5806-02BA is a circuit that can be used in conjunction with a microcontroller in mobile altimeter applications. It is designed for low-voltage systems with a supply voltage of 3 V.

SPI protocol communication

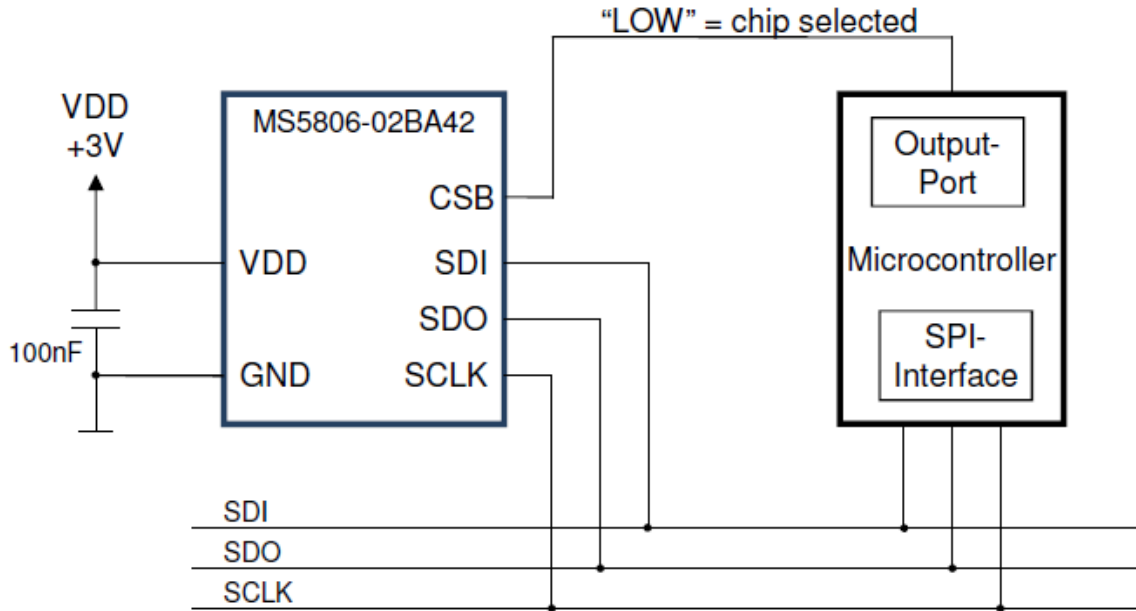

I2C protocol communication

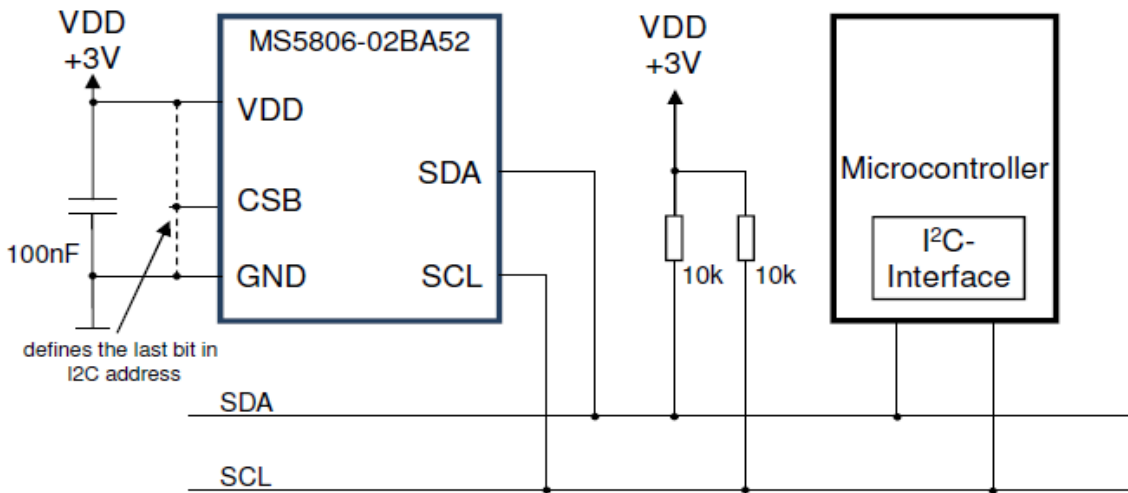

Figure 17: Typical application circuit with SPI / I²C protocol communication

PIN CONFIGURATION AND DEVICE PACKAGE OUTLINE

SPECIFIED DIM ARE IN MILLIMETERS LINEAR DIMENSIONS ± 0.1

NOTE:
1: CAP CENTERING ± 0.15 FROM THE CENTRE OF CERAMIC

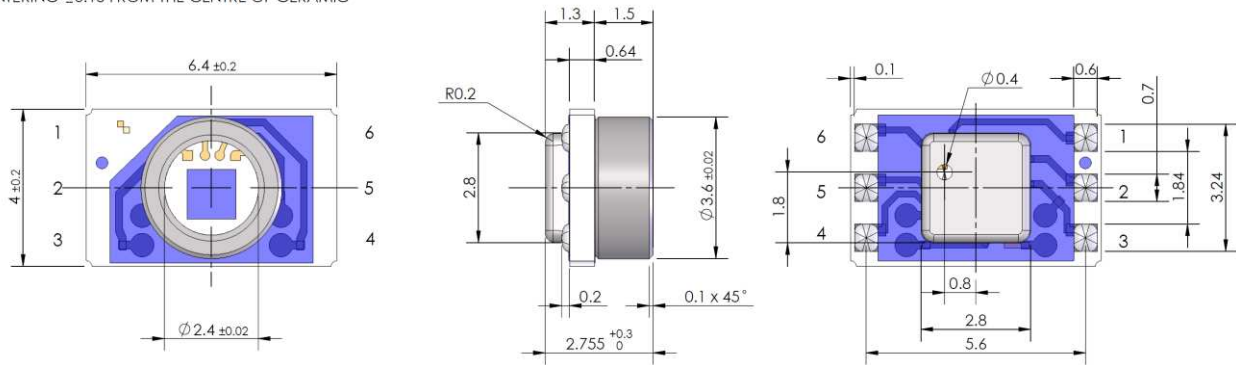

Figure 18: Pin configuration and package outlines, recommended PCB footprint

PIN	NAME: I2C - SPI	TYPE	FUNCTION
1	SDI – SDA	I	Serial Data Input
2	CSB	I	Chip Select (Active low)
3	VDD	P	Positive Supply Voltage
4	GND	G	Ground
5	SCLK – SCL	I	Serial Data Clock
6	SDO - NU	O	Serial Data Out

RECOMMENDED PAD LAYOUT

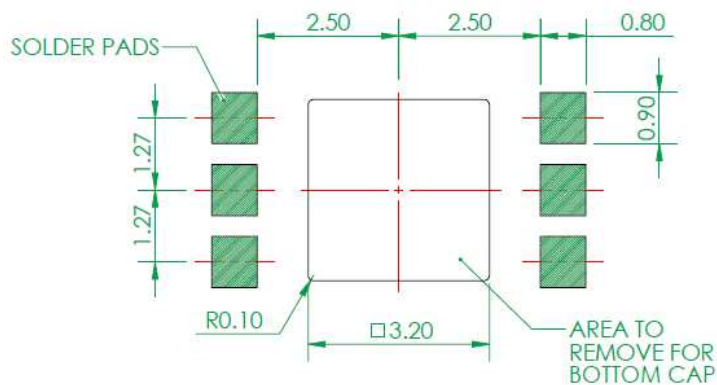
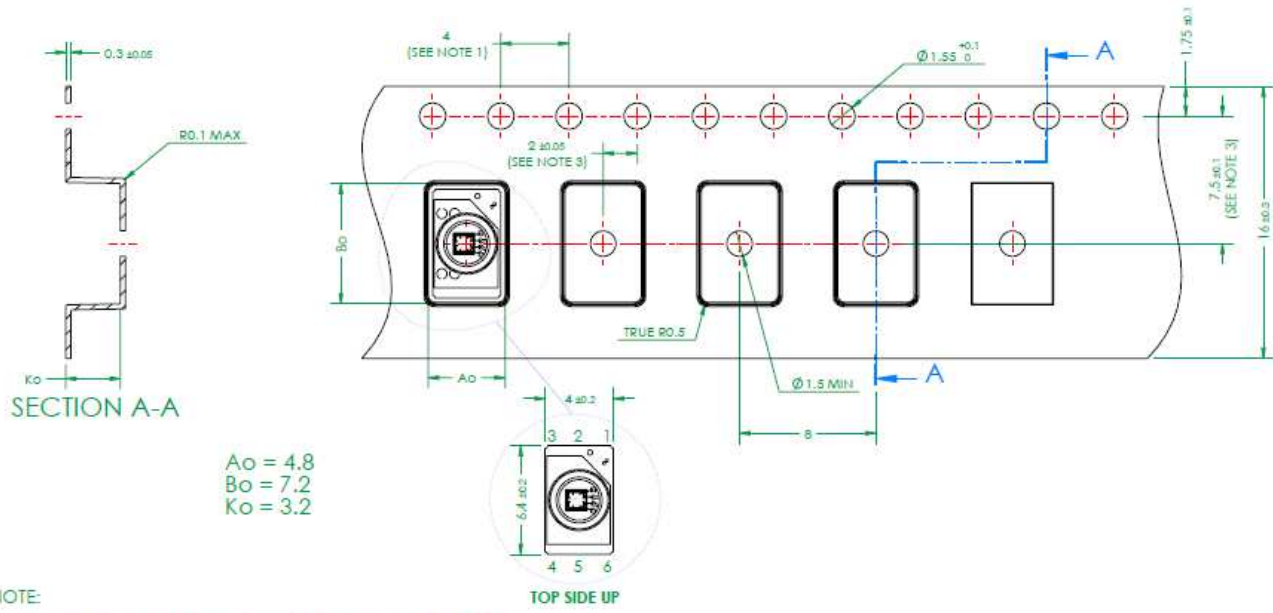

Figure 19: Pin configuration and package outlines, recommended PCB footprint

SHIPPING PACKAGE



NOTE:

- 1: 10 SPROCKET HOLE PITCH CUMULATIVE TOLERANCE ±0.2
- 2: CAMBER IN COMPLIANCE WITH EIA 481
- 3: POCKET POSITION RELATIVE TO SPROCKET HOLE MEASURED AS TRUE POSITION OF POCKET, NOT POCKET HOLE

Figure 20: Tape & reel

MOUNTING AND ASSEMBLY CONSIDERATIONS

SOLDERING

Please refer to the application note AN808 available on our website for all soldering issues.

MOUNTING

The MS5806-02BA can be placed with automatic Pick & Place equipment using vacuum nozzles. It will not be damaged by the vacuum. Due to the low stress assembly the sensor does not show pressure hysteresis effects. It is important to solder all contact pads.

CONNECTION TO PCB

The package outline of the module allows the use of a flexible PCB for interconnection. This can be important for applications in watches and other special devices.

SEALING WITH O-RINGS

In products like outdoor watches the electronics must be protected against direct water or humidity. For those products the MS5806-02BA provides the possibility to seal with an O-ring. The protective cap of the MS5806-02BA is made of special anticorrosive stainless steel with a polished surface. In addition to this the MS5806-02BA is filled with silicone gel covering the sensor and the bonding wires. The O-ring (or O-rings) shall be placed at the outer diameter of the metal cap. This method avoids mechanical stress because the sensor can move in vertical direction.

CLEANING

The MS5806-02BA has been manufactured under cleanroom conditions. It is therefore recommended to assemble the sensor under class 10'000 or better conditions. Should this not be possible, it is recommended to protect the sensor opening during assembly from entering particles and dust. To avoid cleaning of the PCB, solder paste of type "no-clean" shall be used. Cleaning might damage the sensor!

ESD PRECAUTIONS

The electrical contact pads are protected against ESD up to 4 kV HBM (human body model). It is therefore essential to ground machines and personnel properly during assembly and handling of the device. The MS5806-02BA is shipped in antistatic transport boxes. Any test adapters or production transport boxes used during the assembly of the sensor shall be of an equivalent antistatic material.

DECOUPLING CAPACITOR

Particular care must be taken when connecting the device to the power supply. A 100 nF ceramic capacitor must be placed as close as possible to the MS5806-02BA VDD pin. This capacitor will stabilize the power supply during data conversion and thus, provide the highest possible accuracy.

MS5806-02BA

Miniature Altimeter Module

ORDERING INFORMATION

Product Code	Product	Art. No	Delivery Form
MS5806-02BA52	MS5806-02BA I2C Miniature Altimeter Module	MS580602BA52-51	Tape& reel TOP-UP
MS5806-02BA42	MS5806-02BA SPI Miniature Altimeter Module	MS580602BA42-51	Tape& reel TOP-UP

NORTH AMERICA

Measurement Specialties, Inc.,
a TE Connectivity company
Tel: 800-522-6752
Email: customercare.frmt@te.com

EUROPE

Measurement Specialties (Europe), Ltd.,
a TE Connectivity Company
Tel: 800-440-5100
Email: customercare.bevx@te.com

ASIA

Measurement Specialties (China) Ltd.,
a TE Connectivity company
Tel: 0400-820-6015
Email: customercare.shzn@te.com

TE.com/sensorsolutions

Measurement Specialties, Inc., a TE Connectivity company.

Measurement Specialties, TE Connectivity, TE Connectivity (logo) and EVERY CONNECTION COUNTS are trademarks. All other logos, products and/or company names referred to herein might be trademarks of their respective owners.

The information given herein, including drawings, illustrations and schematics which are intended for illustration purposes only, is believed to be reliable. However, TE Connectivity makes no warranties as to its accuracy or completeness and disclaims any liability in connection with its use. TE Connectivity's obligations shall only be as set forth in TE Connectivity's Standard Terms and Conditions of Sale for this product and in no case will TE Connectivity be liable for any incidental, indirect or consequential damages arising out of the sale, resale, use or misuse of the product. Users of TE Connectivity products should make their own evaluation to determine the suitability of each such product for the specific application.

© 2015 TE Connectivity Ltd. family of companies All Rights Reserved.