

MCL0606FRD1GR2T DATASHEET

Multi Color LED, 0606, Flat Lens, Red, Green



VENKEL LTD.

Part Number	Size	Emitting Color	Emitting Material	Lens-Color	Luminous Intensity mcd	Wavelength nm λ_P	Viewing Angle (2θ 1/2)
MCL0606FRD1GR2T	0606	Red, Green	AlGaInP, InGaN/GaN	Clear	Red: 32mcd Min 200mcd Max Green: 200mcd Min 800mcd Max	Red: 642nm typ Green: 518nm typ	130°

Electrical & Optical Specifactions ($T_A=25^\circ\text{C}$)		Red @20mA	Green @20mA	Unit
Forward Voltage Min.	V_F	1.5	2.6	V
Forward Voltage Max.	V_F	2.4	3.6	V
Reverse Current (Max) ($V_R=5V$)	I_R	10	50	μA
Peak Wavelength Typ.	λ_P	642	518	nm
Dominant Wavelength Min.	λ_D	627	520	nm
Spectral Line Half Width Typ.	$\Delta\lambda$	20	20	nm

Absolute Maximum Ratings ($T_A=25^\circ\text{C}$)		Red	Green	Unit
Reverse Voltage	V_R	5	5	V
DC Forward Current	I_F	30	20	mA
Peak Forward Current 1/10 Duty Cycle @ 10KHz	I_{FP}	90	100	mA
Power Dissipation	P_D	72	30	mW
Operating Temperature	T_A	-20 ~ +80		°C
Storage Temperature	T_{stg}	-30 ~ +100		

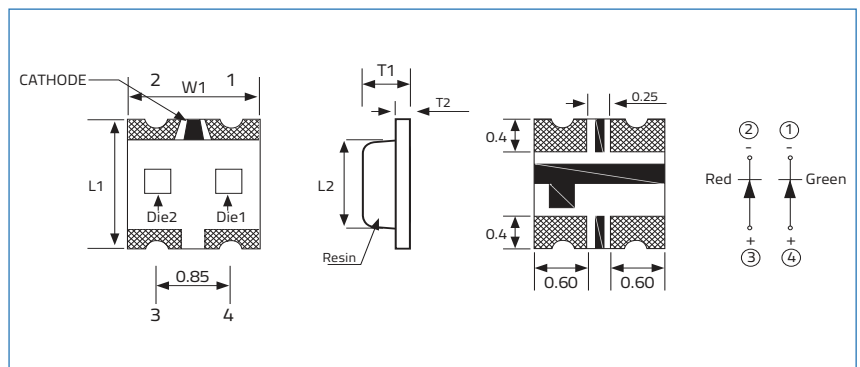

Dimensions				Units: Inches (mm)			
L_1	L_2	T_1	T_2	L_1	L_2	T_1	T_2
0.063±0.004 (1.6±0.1)	0.043±0.004 (1.1±0.1)	0.0216±0.004 (0.55±0.1)	0.0071±0.004 (0.18±0.1)				
W_1							
0.059±0.004 (1.5±0.1)							

Soldering Pad Layout

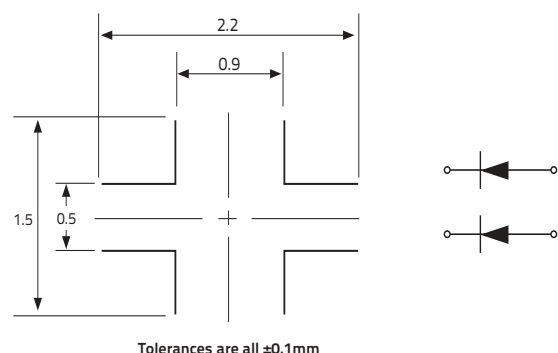

MCL0606FRD1GR2T DATASHEET

Multi Color LED, 0606, Flat Lens, Red, Green



VENKEL LTD.

Graphs for Red (AlGaInP)

Fig.1 Forward Current vs Forward Voltage

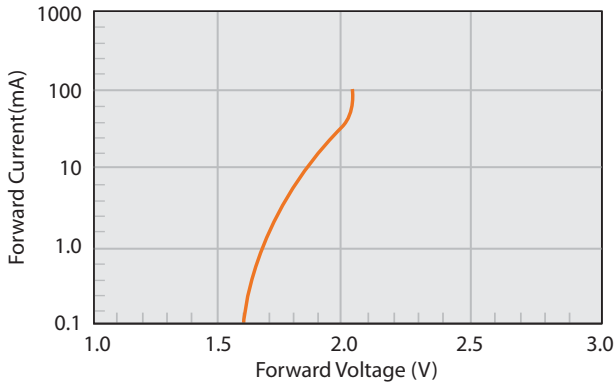

Fig.4 Relative Intensity vs Temperature

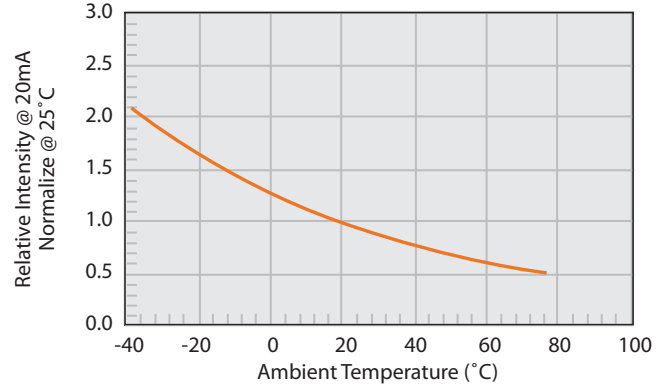

Fig.2 Relative Intensity vs Forward Current

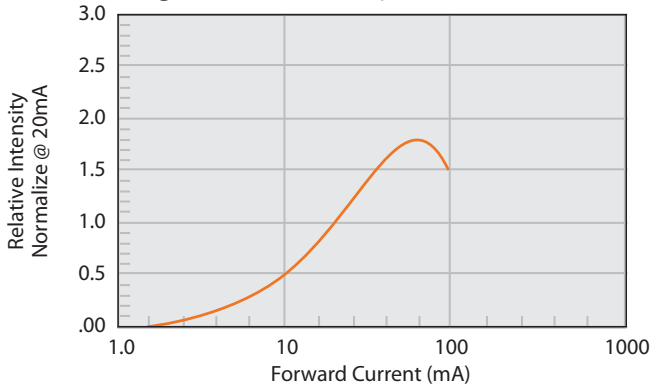

Fig.5 Relative Intensity vs Wavelength

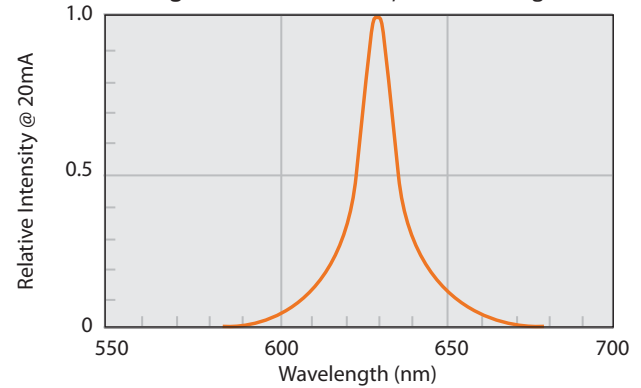

Fig.3 Current vs Temp

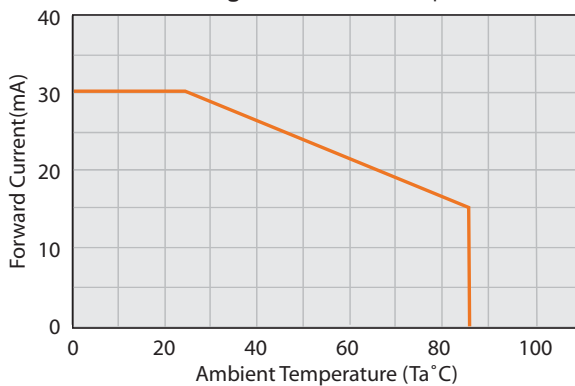
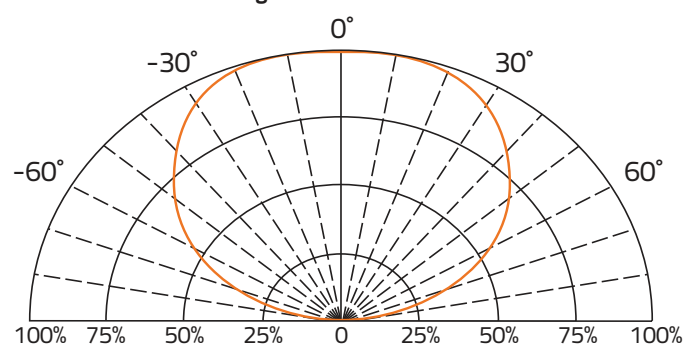

Fig. 6 Direct Radiation



Environmental information

RoHS Status	6 of 6 Compliant
REACH Status	Compliant
Halogen Status	Halogen Free
Conflict Mineral Status	Conflict Mineral Free
Moisture Sensitivity Level (MSL)	3

Reflow profile

Max Reflow Temperature	260°C
Number of Reflow Cycles	2

MCL0606FRD1GR2T DATASHEET

Multi Color LED, 0606, Flat Lens, Red, Green



VENKEL LTD.

Graphs for Green (InGaN/GaN)

Fig.1 Forward Current vs Forward Voltage

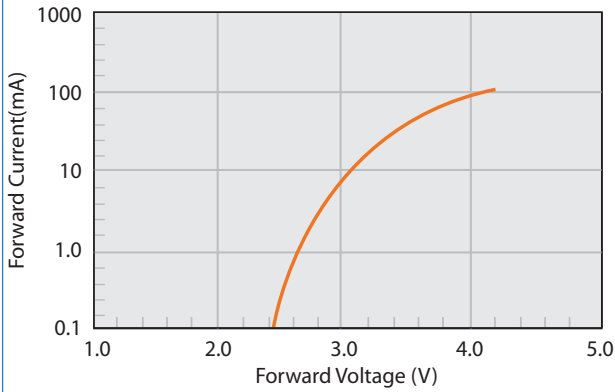

Fig.2 Relative Intensity vs Forward Current

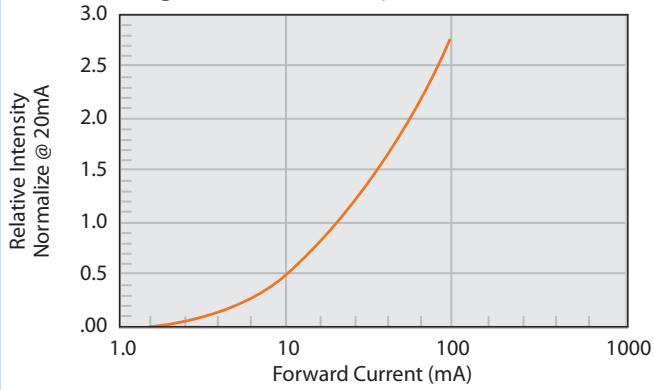

Fig.3 Forward Voltage vs Temperature

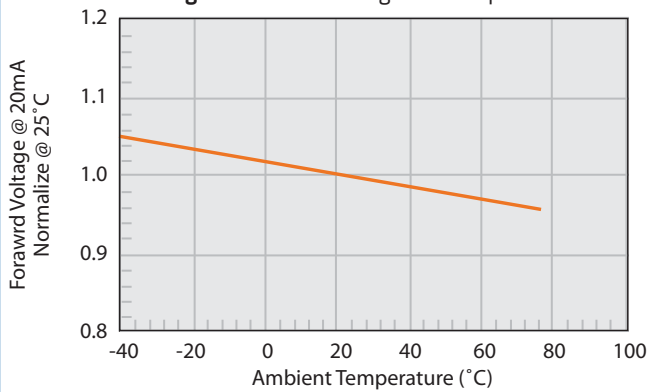

Fig.4 Relative Intensity vs Temperature

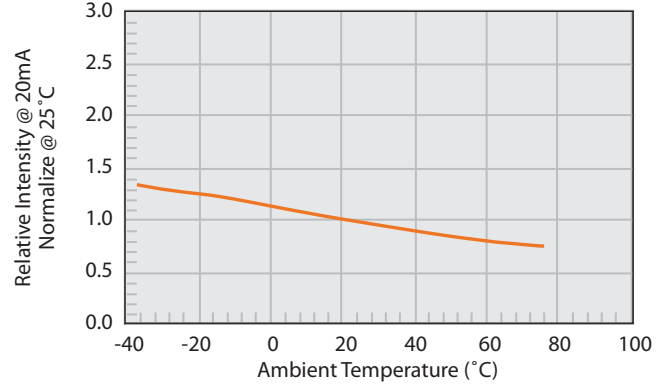

Fig.5 Relative Intensity vs Wavelength

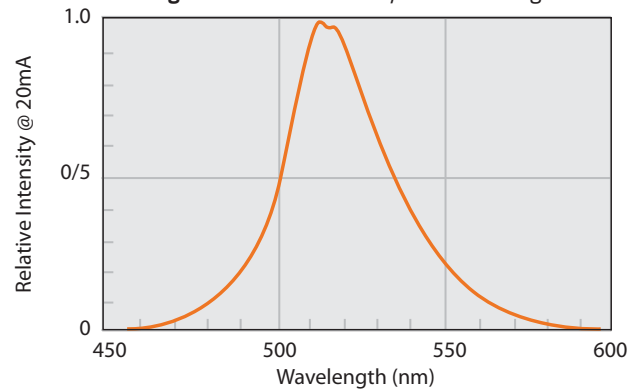
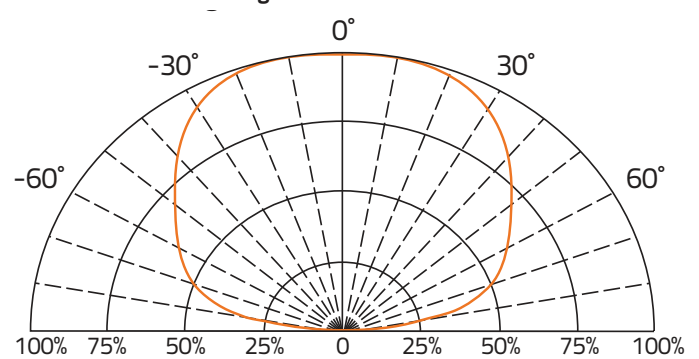

Fig. 6 Direct Radiation



MCL0606FRD1GR2T DATASHEET

Multi Color LED, 0606, Flat Lens, Red, Green



VENKEL LTD.

Label Example

Item: MCL0606FRD1GR2T
 Chip Type LED,0606,Flat Lens,Red,Green
 Qty: 4000 D/C: 1616
 Lot: GS115A0168
 BIN/HUE: P/30-M/8 VF: 1.5-2.4
 VF: 2.6-3.6
VENKEL LTD
YOUR SINGLE SOURCE FOR SURFACE MOUNT PASSIVES

Codes:

VF: Forward Voltage | BIN: Luminous Intensity | HUE: Dominant Wavelength

Luminous Intensity Classification (BIN Code)

RED BIN Code	Iv(mcd) at 20mA	
	Min.	Max.
N	32	50
P	50	80
Q	80	125
R	125	200

Green BIN Code	Iv(mcd) at 20mA	
	Min.	Max.
S	200	320
T	320	500
U	500	800

Dominant Wavelength Classification (HUE Code)

λ_D (nm) at 20mA					
Red			Green		
Hue Code	Min.	Max.	Hue Code	Min.	Max.
29	624	627	1N	516	519
30	627	630	1O	519	522
31	630	633	1P	522	525
32	633	636	1Q	525	528
33	636	639	1R	528	531

MCL0606FRD1GR2T DATASHEET

Multi Color LED, 0606, Flat Lens, Red, Green



VENKEL LTD.

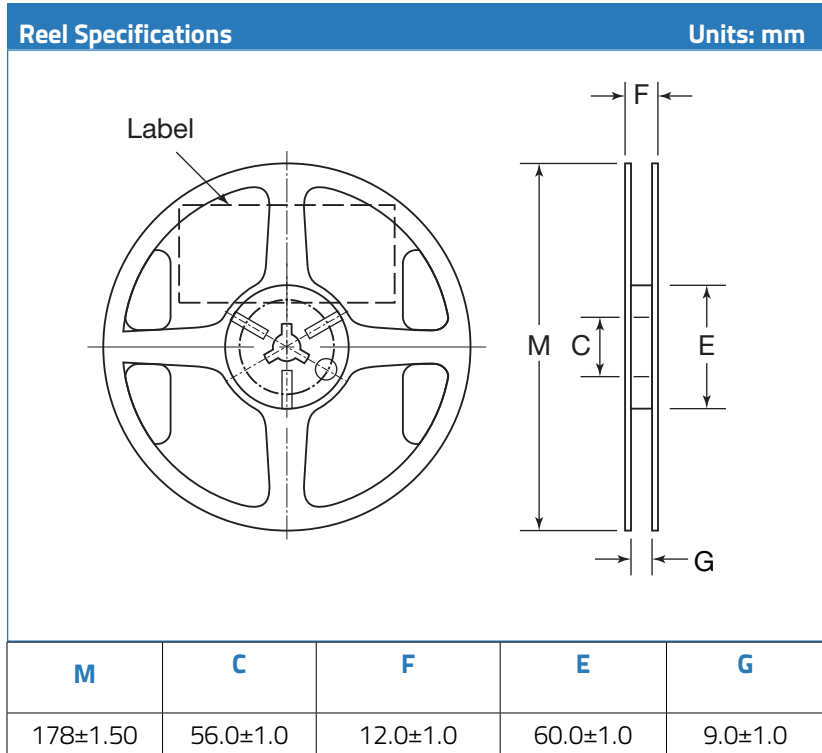

Packaging Specifications

Reel Size:	7"
Quantity per Reel :	4,000

- Storage Specifications**
1. Storage temperature and RH: 5°C~35°C, RH60%
 2. Once the package is opened, the LEDs should be used within a week. Otherwise, they should be kept in a moisture proof bag with desiccant. We suggest that you use this product within one year from date code.
 3. If opened for more than one week in an atmosphere of 5°C~35°C, RH60%. The parts should be heat treated at 60°C±5°C for 15 hours.

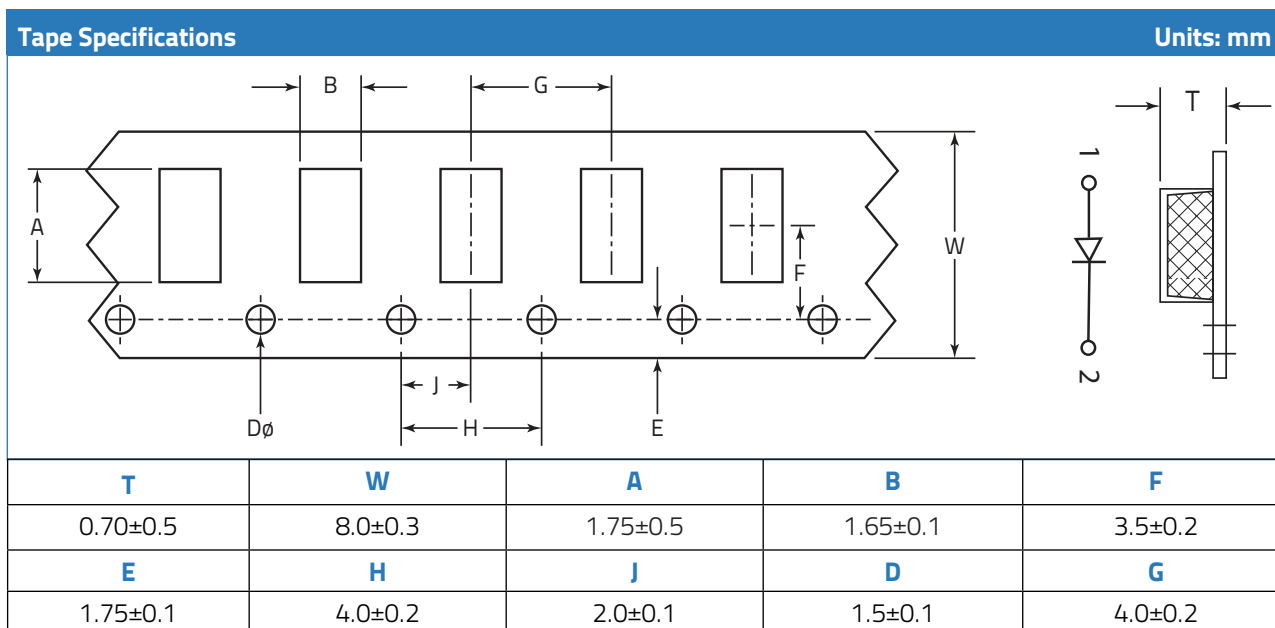

MCL0606FRD1GR2T DATASHEET

Multi Color LED, 0606, Flat Lens, Red, Green



VENKEL LTD.

Environmental Test Criteria			
Classification	Test Item	Test Condition	Sample Size
Endurance Test	Operating Life	1. Ta=25°C 2. If=20mA 3. t=1000hrs (-24hrs, +72hrs)	22
	High Temperature Storage	1. Ta=105°C±5°C 2. t=1000hrs (-24hrs, +72hrs)	22
	Low Temperature Storage	1. Ta=-40°C±5°C 2. t=1000hrs (-24hrs, +72hrs)	22
	High Temperature, High Humidity Storage	1. Ta=85°C 2. RH=85% 3. t=1000hrs(-24hrs, +72hrs)	22
Environmental Test	Thermal Shock	1. Ta=100°C±5°C & -40°C±5°C 20min / 10sec / 20min 3. Total: 100 cycles total	22
	Temperature Cycling	1. 100°C±5°C & -40°C±5°C 30mins / 5mins / 30mins 2. 100 Cycles	22
	IR Reflow	1. T=260°C Max. 10 seconds Max 2. 6 Min	22

Drive Method

LED is a current operated drive, and therefore it requires some kind of current limiting incorporated into the driver circuit. This current limiting typically takes the form of a current limiting resistor placed in series with the LED. Consider worst case voltage variations that can occur across the current limiting resistor placed in series with the LED. The forward current should not be allowed to change by more than 40% of its desired value.

Circuit model A

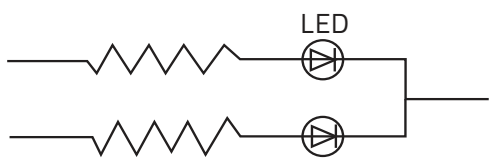

Circuit model B

