

Silicon carbide Power MOSFET 1200 V, 20 A, 189 mΩ (typ., $T_J = 150\text{ °C}$) in an HiP247 package

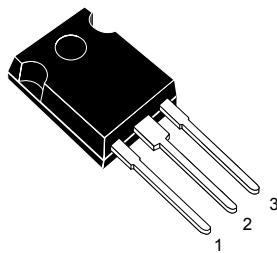

HiP247

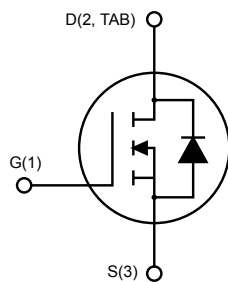

AM01475v1_noZen

Product status link
[SCT20N120](#)
Product summary

Order code	SCT20N120
Marking	SCT20N120
Package	HiP247
Packing	Tube

Features

- Very tight variation of on-resistance vs. temperature
- Very high operating junction temperature capability ($T_J = 200\text{ °C}$)
- Very fast and robust intrinsic body diode
- Low capacitance

Applications

- Solar inverters, UPS
- Motor drives
- High voltage DC-DC converters
- Switch mode power supplies

Description

This silicon carbide Power MOSFET is produced exploiting the advanced, innovative properties of wide bandgap materials. This results in unsurpassed on-resistance per unit area and very good switching performance almost independent of temperature. The outstanding thermal properties of the SiC material, combined with the device's housing in the proprietary HiP247 package, allows designers to use an industry standard outline with significantly improved thermal capability. These features render the device perfectly suitable for high-efficiency and high power density applications.

1 Electrical ratings

Table 1. Absolute maximum ratings

Symbol	Parameter	Value	Unit
V_{DS}	Drain-source voltage	1200	V
V_{GS}	Gate-source voltage	-10 to 25	V
I_D	Drain current (continuous) at $T_C = 25\text{ }^\circ\text{C}$	20	A
I_D	Drain current (continuous) at $T_C = 100\text{ }^\circ\text{C}$	16	A
$I_{DM}^{(1)}$	Drain current (pulsed)	45	A
P_{TOT}	Total power dissipation at $T_C = 25\text{ }^\circ\text{C}$	175	W
T_{stg}	Storage temperature range	-55 to 200	$^\circ\text{C}$
T_j	Operating junction temperature range		$^\circ\text{C}$

1. Pulse width limited by safe operating area.

Table 2. Thermal data

Symbol	Parameter	Value	Unit
$R_{thj-case}$	Thermal resistance junction-case	1	$^\circ\text{C/W}$
$R_{thj-amb}$	Thermal resistance junction-ambient	40	$^\circ\text{C/W}$

2 Electrical characteristics

($T_{CASE} = 25\text{ °C}$ unless otherwise specified).

Table 3. On/off states

Symbol	Parameter	Test conditions	Min.	Typ.	Max.	Unit
I_{DSS}	Zero gate voltage drain current	$V_{GS} = 0\text{ V}, V_{DS} = 1200\text{ V}$			100	μA
		$V_{GS} = 0\text{ V}, V_{DS} = 1200\text{ V}, T_J = 200\text{ °C}$		50		
I_{GSS}	Gate-body leakage current	$V_{DS} = 0\text{ V}, V_{GS} = -10\text{ to }22\text{ V}$			100	nA
$V_{GS(th)}$	Gate threshold voltage	$V_{DS} = V_{GS}, I_D = 1\text{ mA}$	2	3.5		V
$R_{DS(on)}$	Static drain-source on-resistance	$V_{GS} = 20\text{ V}, I_D = 10\text{ A}$		169	239	m Ω
		$V_{GS} = 20\text{ V}, I_D = 10\text{ A}, T_J = 150\text{ °C}$		189		
		$V_{GS} = 20\text{ V}, I_D = 10\text{ A}, T_J = 200\text{ °C}$		220		

Table 4. Dynamic

Symbol	Parameter	Test conditions	Min.	Typ.	Max.	Unit
C_{iss}	Input capacitance	$V_{DS} = 400\text{ V}, f = 1\text{ MHz}, V_{GS} = 0\text{ V}$	-	650	-	pF
C_{oss}	Output capacitance		-	65	-	pF
C_{riss}	Reverse transfer capacitance		-	14	-	pF
Q_g	Total gate charge	$V_{DD} = 800\text{ V}, I_D = 10\text{ A}, V_{GS} = 0\text{ to }20\text{ V}$	-	45	-	nC
Q_{gs}	Gate-source charge		-	7	-	nC
Q_{gd}	Gate-drain charge		-	11.7	-	nC
R_g	Gate input resistance		$f=1\text{ MHz}, I_D = 0\text{ A}$	-	7	-

Table 5. Switching energy (inductive load)

Symbol	Parameter	Test conditions	Min.	Typ.	Max.	Unit
E_{on}	Turn-on switching energy	$V_{DD} = 800\text{ V}, I_D = 10\text{ A}$ $R_G = 6.8\ \Omega, V_{GS} = -2\text{ to }20\text{ V}$	-	160	-	μJ
E_{off}	Turn-off switching energy		-	90	-	μJ
E_{on}	Turn-on switching energy	$V_{DD} = 800\text{ V}, I_D = 10\text{ A}$ $R_G = 6.8\ \Omega, V_{GS} = -2\text{ to }20\text{ V}, T_J = 150\text{ °C}$	-	165	-	μJ
E_{off}	Turn-off switching energy		-	100	-	μJ

Table 6. Switching times

Symbol	Parameter	Test conditions	Min.	Typ.	Max.	Unit
$t_{d(on)V}$	Turn-on delay time	$V_{DD} = 800\text{ V}$, $I_D = 10\text{ A}$, $R_G = 0\ \Omega$, $V_{GS} = 0\text{ to }20\text{ V}$	-	10	-	ns
$t_{f(V)}$	Fall time		-	17	-	ns
$t_{d(off)V}$	Turn-off delay time		-	27	-	ns
$t_{r(V)}$	Rise time		-	16	-	ns

Table 7. Reverse SiC diode characteristics

Symbol	Parameter	Test conditions	Min.	Typ.	Max.	Unit
V_{SD}	Diode forward voltage	$I_F = 5\text{ A}$, $V_{GS} = -5\text{ V}$	-	3.6	-	V
t_{rr}	Reverse recovery time	$I_{SD} = 10\text{ A}$, $V_{GS} = -5\text{ V}$, $V_R = 800\text{ V}$, $di/dt = 1650\text{ A}/\mu\text{s}$	-	15	-	ns
Q_{rr}	Reverse recovery charge		-	75	-	nC
I_{rrm}	Peak reverse recovery current		-	8	-	A

2.1 Electrical characteristics (curves)

Figure 1. Safe operating area

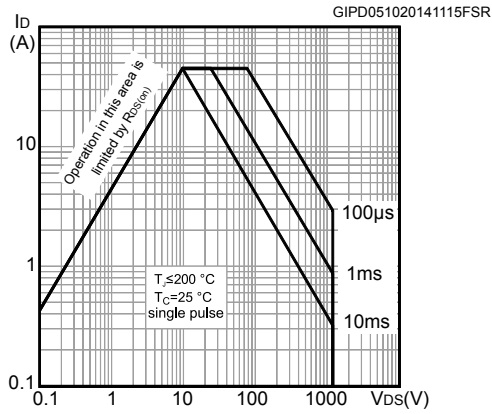

Figure 2. Typical thermal impedance

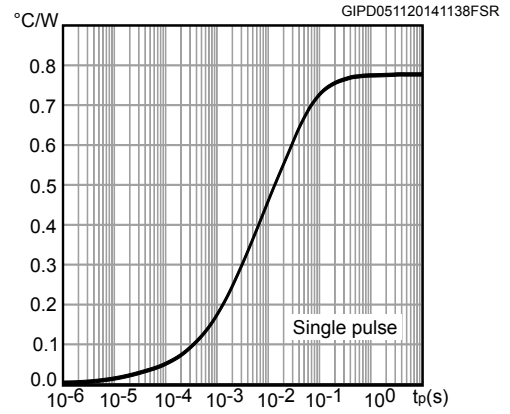

Figure 3. Output characteristics @ $T_J = 25\text{ }^\circ\text{C}$

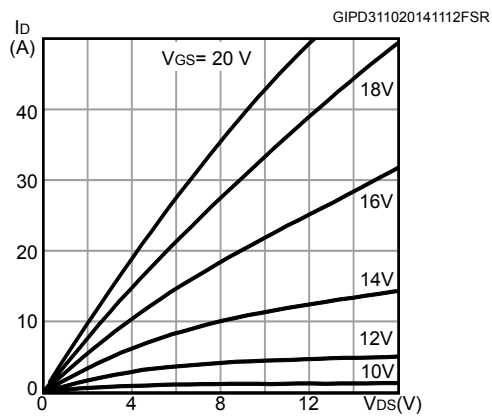

Figure 4. Output characteristics @ $T_J = 200\text{ }^\circ\text{C}$

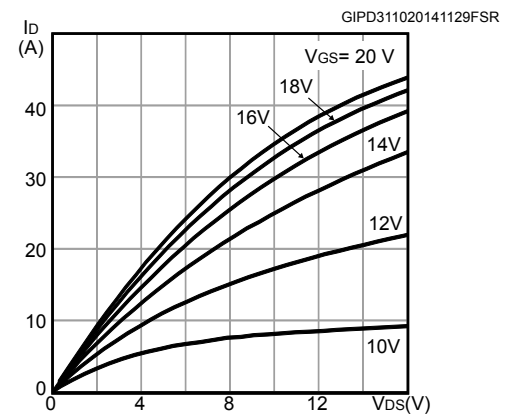

Figure 5. Transfer characteristics

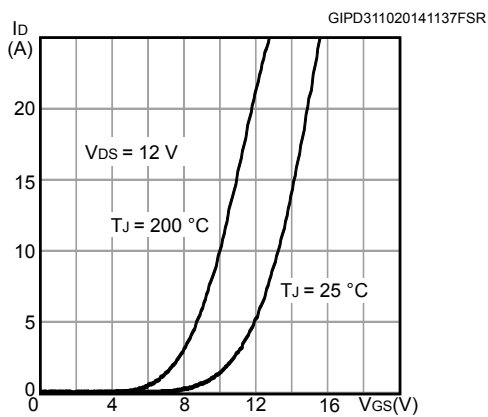

Figure 6. Body diode characteristics @ $T_J = -50\text{ }^\circ\text{C}$

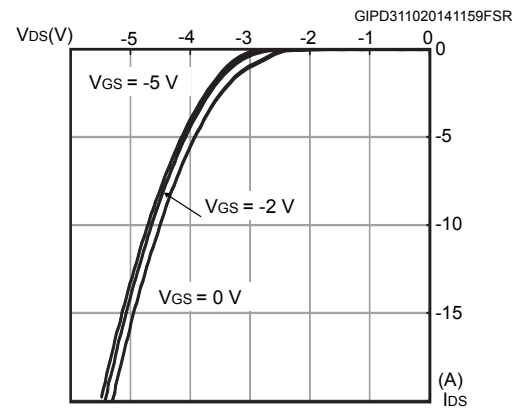

Figure 7. Body diode characteristics @ $T_J = 25\text{ }^\circ\text{C}$

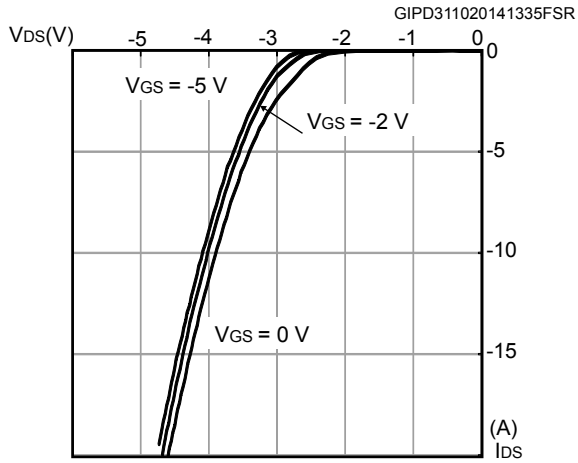

Figure 8. Body diode characteristics @ $T_J = 150\text{ }^\circ\text{C}$

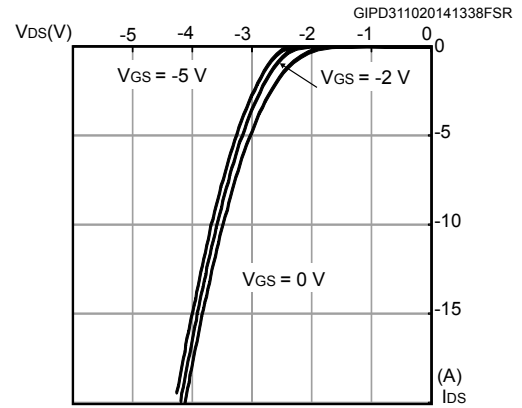

Figure 9. 3rd quadrant characteristics @ $T_J = -50\text{ }^\circ\text{C}$

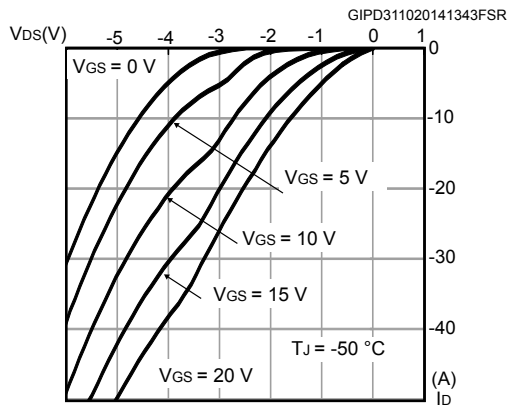

Figure 10. 3rd quadrant characteristics @ $T_J = 25\text{ }^\circ\text{C}$

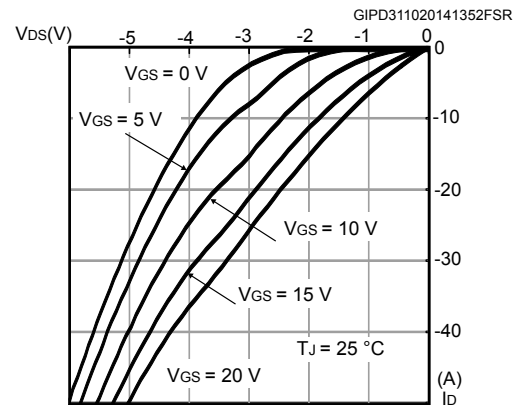

Figure 11. 3rd quadrant characteristics @ $T_J = 150\text{ }^\circ\text{C}$

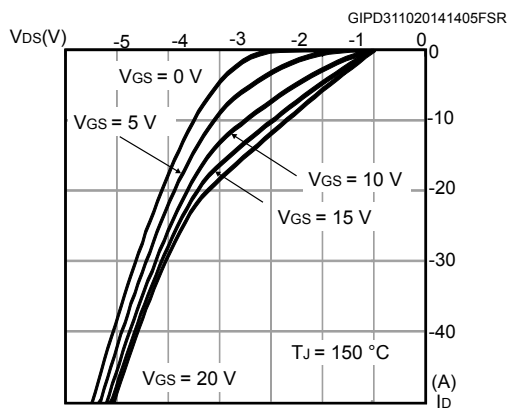

Figure 12. Normalized gate threshold vs. temperature

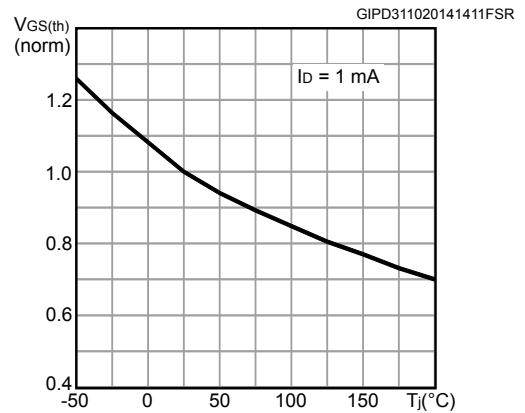

Figure 13. Normalized $R_{DS(on)}$ vs. temperature

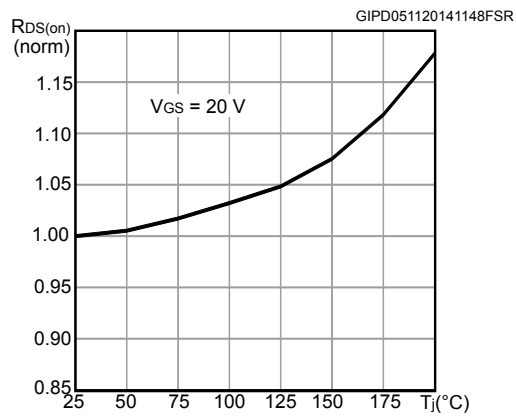
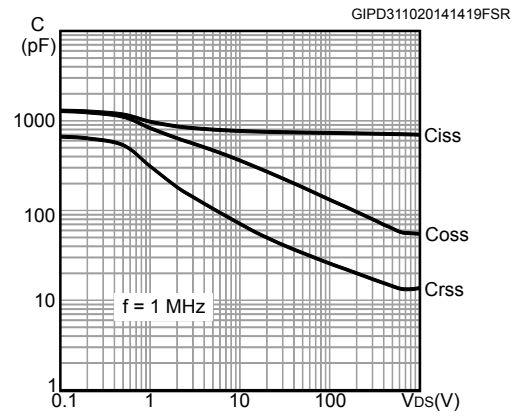
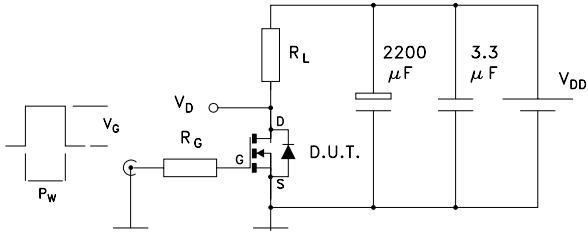

Figure 14. Capacitances variation



3 Test circuits

Figure 15. Switching test waveforms for transition times



GIPD101020141511FSR

Figure 16. Clamped inductive switching waveform

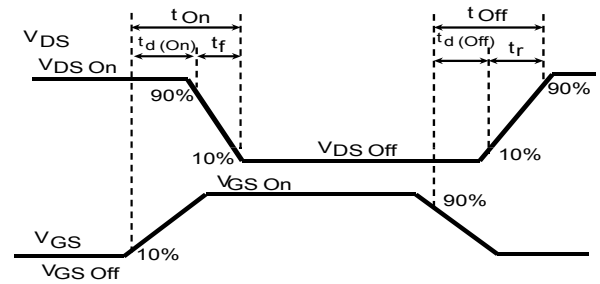

GIPD101020141502FSR

4 Package information

In order to meet environmental requirements, ST offers these devices in different grades of **ECOPACK** packages, depending on their level of environmental compliance. ECOPACK specifications, grade definitions and product status are available at: www.st.com. ECOPACK is an ST trademark.

4.1 HiP247 package information

Figure 17. HiP247 package outline

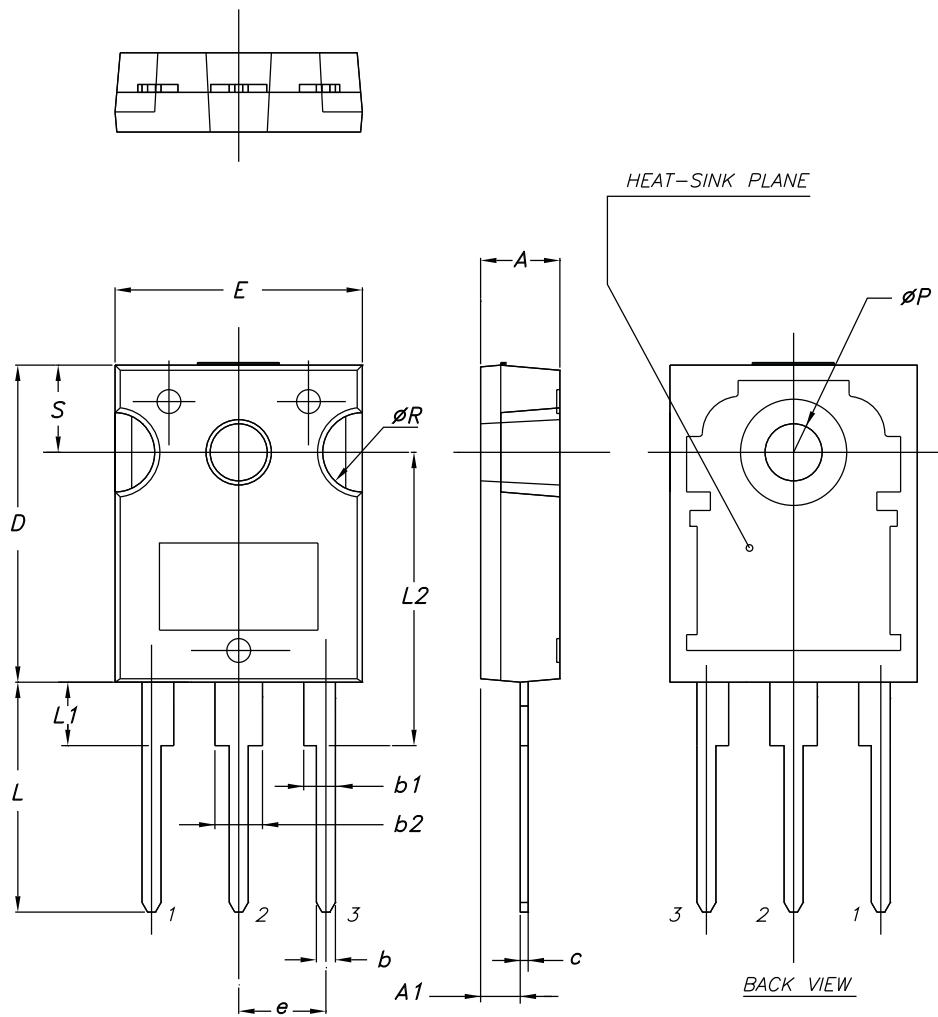

8396756_2

Table 8. HiP247 package mechanical data

Dim.	mm		
	Min.	Typ.	Max.
A	4.85	5.00	5.15
A1	2.20		2.60
b	1.0		1.40
b1	2.0		2.40
b2	3.0		3.40
c	0.40		0.80
D	19.85		20.15
E	15.45		15.75
e	5.30	5.45	5.60
L	14.20		14.80
L1	3.70		4.30
L2		18.50	
∅P	3.55		3.65
∅R	4.50		5.50
S	5.30	5.50	5.70

Revision history

Table 9. Document revision history

Date	Revision	Changes
07-Nov-2014	1	First release
17-Feb-2015	2	Updated title in cover page.
20-Feb-2015	3	Updated <i>Figure 3: Thermal impedance</i> . Minor text changes.
17-Dec-2015	4	Updated title in cover page and <i>Table 4: On/off states</i> .
17-Sep-2019	5	Updated <i>Figure 1. Safe operating area</i> and <i>Section 4.1 HiP247 package information</i> . Minor text changes.

Contents

1	Electrical ratings	2
2	Electrical characteristics	3
2.1	Electrical characteristics (curves)	5
3	Test circuits	8
4	Package information	9
4.1	HiP247 package information	9
	Revision history	11
	Contents	12

IMPORTANT NOTICE – PLEASE READ CAREFULLY

STMicroelectronics NV and its subsidiaries (“ST”) reserve the right to make changes, corrections, enhancements, modifications, and improvements to ST products and/or to this document at any time without notice. Purchasers should obtain the latest relevant information on ST products before placing orders. ST products are sold pursuant to ST’s terms and conditions of sale in place at the time of order acknowledgement.

Purchasers are solely responsible for the choice, selection, and use of ST products and ST assumes no liability for application assistance or the design of Purchasers’ products.

No license, express or implied, to any intellectual property right is granted by ST herein.

Resale of ST products with provisions different from the information set forth herein shall void any warranty granted by ST for such product.

ST and the ST logo are trademarks of ST. For additional information about ST trademarks, please refer to www.st.com/trademarks. All other product or service names are the property of their respective owners.

Information in this document supersedes and replaces information previously supplied in any prior versions of this document.

© 2019 STMicroelectronics – All rights reserved