

76829-0106 SHOWN

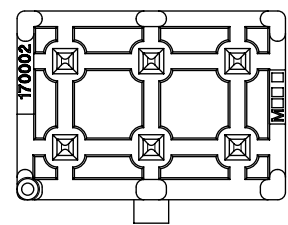
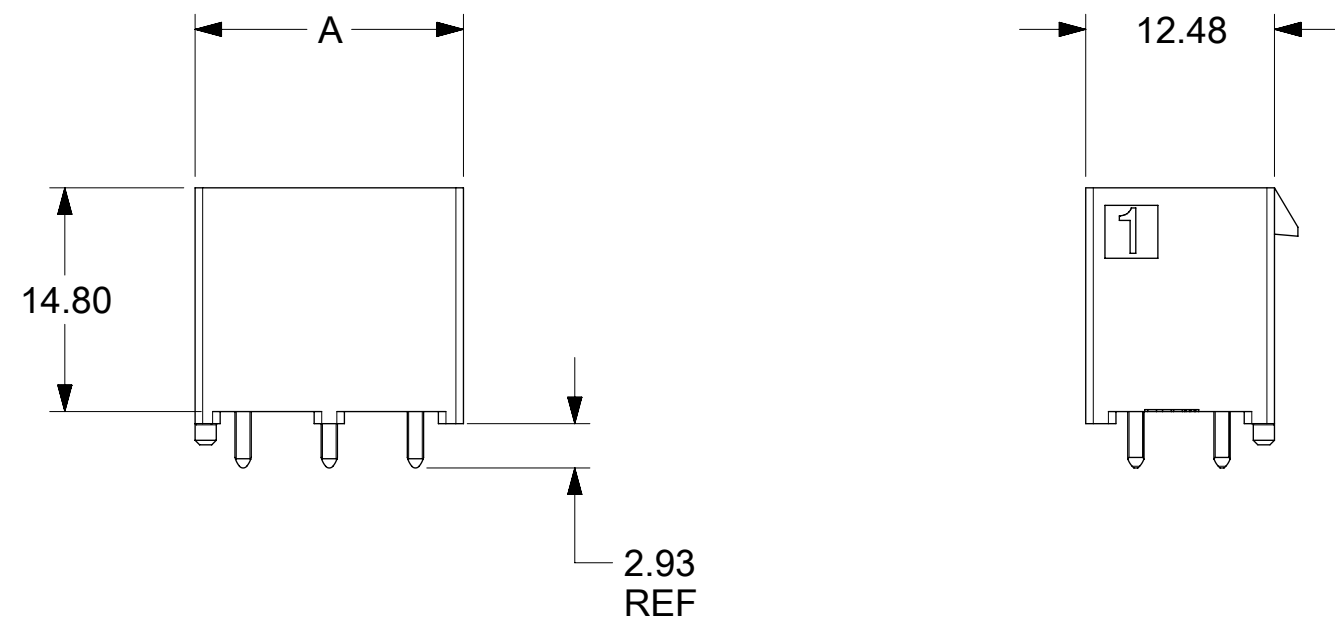

NOTES:

1. MATERIAL:  
HOUSING: LCP, UL94V-0, GLOW WIRE CAPABLE PER IEC-60335-1 5TH EDITION,  
COLOR: BLACK.  
TERMINAL: HIGH CONDUCTIVITY COPPER.
2. TERMINAL PLATING:  
(TIN) 1.52 MICROMETER /(60 MICROINCH) MIN REFLOWED MATTE TIN OVER  
1.27 MICROMETER /(50 MICROINCH) MIN NICKEL OVERALL.  
(15 GOLD) 0.38 MICROMETER /(15 MICROINCH) MIN SELECT GOLD ON CONTACT AREA  
2.54 MICROMETER /(100 MICROINCH) MIN SELECT MATTE TIN ON SOLDER AREA  
BOTH OVER 1.27 MICROMETER /(50 MICROINCH) MIN NICKEL OVERALL  
(30 GOLD) 0.76 MICROMETER /(30 MICROINCH) MIN SELECT GOLD ON CONTACT AREA  
2.54 MICROMETER /(100 MICROINCH) MIN SELECT MATTE TIN ON SOLDER AREA  
BOTH OVER 1.27 MICROMETER /(50 MICROINCH) MIN NICKEL OVERALL
3. PRODUCT SPECIFICATION:PS-76823-100/1720631000-PS
4. PART MATES WITH MOLEX PART NUMBER 170001 AND 171692 SERIES.
5. PACKAGING SPECIFICATION:768291100 (TRAY) , 1720659206-PK (T & R), AND 1720658000 (T&R W/ KAPTON)
6. APPLICATION SPECIFICATION:AS-76823-100/ 768232000-AS
7. PARTS CONFORM TO CLASS "B" REQUIREMENTS OF COSMETIC SPECIFICATION PS-45499-002.

THIS DRAWING CONTAINS INFORMATION THAT IS PROPRIETARY TO MOLEX ELECTRONIC TECHNOLOGIES, LLC AND SHOULD NOT BE USED WITHOUT WRITTEN PERMISSION

DIMENSION UNITS		SCALE		CURRENT REV DESC:				<b>molex</b>							
mm		NTS													
GENERAL TOLERANCES (UNLESS SPECIFIED)				EC NO: 722781				MEGAFIT SLIM VERTICAL HEADER ASSY WITHOUT CRUSH PEGS 2-12 CKT							
ANGULAR TOL ± 3.0°				DRWN: WYATTH5 2022/10/14											
4 PLACES ±				CHK'D: XQZHANG 2022/10/27				PRODUCT CUSTOMER DRAWING							
3 PLACES ±				APPR: XQZHANG 2022/10/27											
2 PLACES ± 0.25				INITIAL REVISION:				DOCUMENT NUMBER		DOC TYPE		DOC PART		REVISION	
1 PLACE ±				DRWN: GSHARMA 2016/07/15				768290002		PSD		000		A5	
0 PLACES ±				APPR: KPRASAD 2017/07/21				MATERIAL NUMBER		CUSTOMER		SHEET NUMBER			
DRAFT WHERE APPLICABLE MUST REMAIN WITHIN DIMENSIONS				THIRD ANGLE PROJECTION		DRAWING		SERIES		SEE TABLE		GENERAL MARKET		1 OF 3	

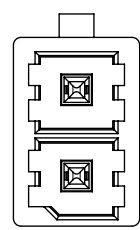

2 CKT

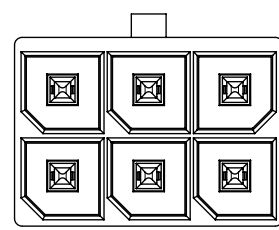

4-12 CKT

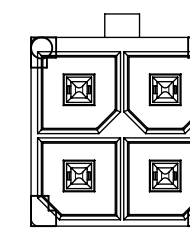

4 CKT

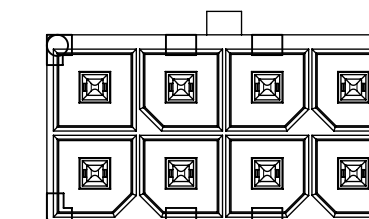
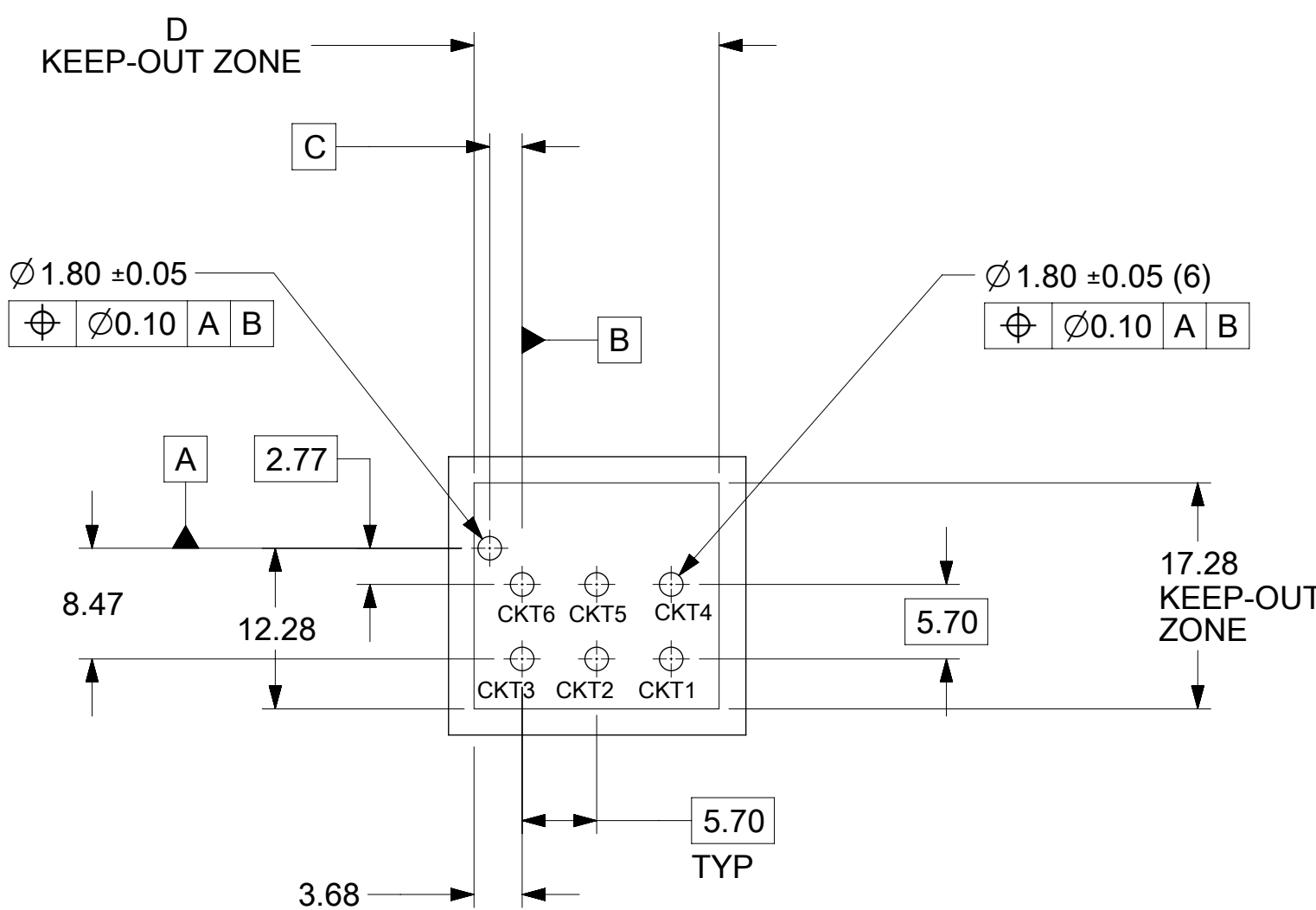
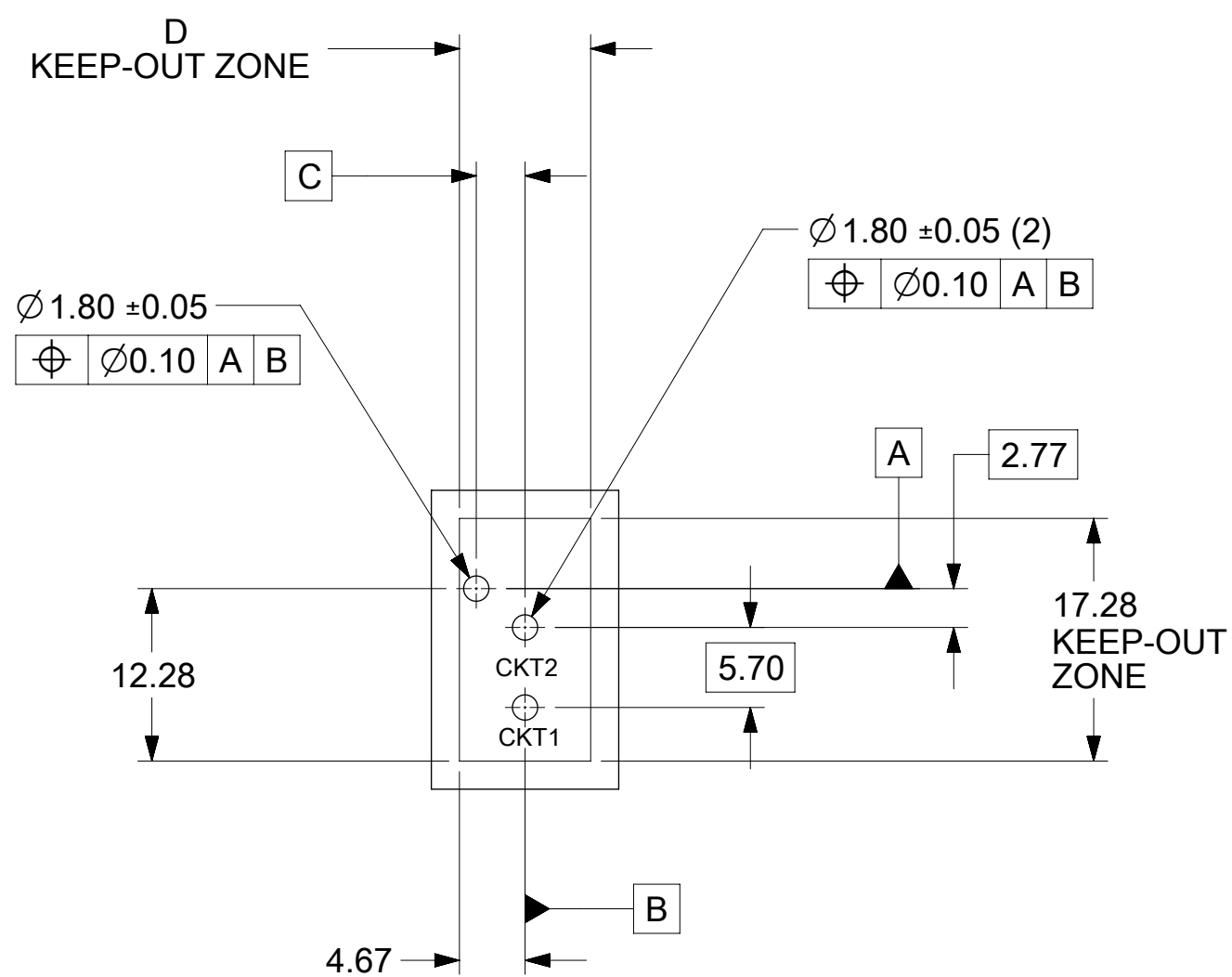

8 CKT

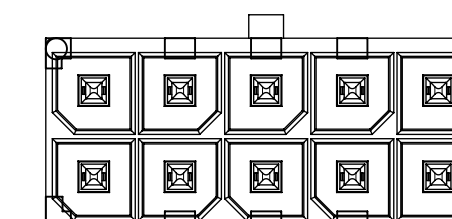

10 CKT

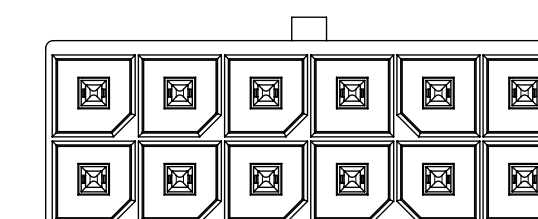

12 CKT

THIS DRAWING CONTAINS INFORMATION THAT IS PROPRIETARY TO MOLEX ELECTRONIC TECHNOLOGIES, LLC AND SHOULD NOT BE USED WITHOUT WRITTEN PERMISSION									
DIMENSION UNITS	SCALE	CURRENT REV DESC:				molex			
mm	NTS					MEGAFIT SLIM VERTICAL HEADER ASSY WITHOUT CRUSH PEGS 2-12 CKT			
GENERAL TOLERANCES (UNLESS SPECIFIED)		EC NO: 722781				PRODUCT CUSTOMER DRAWING			
ANGULAR TOL $\pm 3.0^\circ$		4 PLACES $\pm$		DRWN: WYATTH5 2022/10/14		DOCUMENT NUMBER			
3 PLACES $\pm$		3 PLACES $\pm$		CHK'D: XQZHANG 2022/10/27		768290002		DOC TYPE DOC PART REVISION	
2 PLACES $\pm 0.25$		2 PLACES $\pm 0.25$		APPR: XQZHANG 2022/10/27		PSD 000		A5	
1 PLACE $\pm$		1 PLACE $\pm$		INITIAL REVISION:		MATERIAL NUMBER CUSTOMER SHEET NUMBER			
0 PLACES $\pm$		0 PLACES $\pm$		DRWN: GSHARMA 2016/07/15		SEE TABLE		GENERAL MARKET 2 OF 3	
DRAFT WHERE APPLICABLE MUST REMAIN WITHIN DIMENSIONS		THIRD ANGLE PROJECTION		DRAWING		SERIES		76829	
		C-SIZE		76829					

CKT SIZE	PART NO.	PLATING	DIM A	DIM C BASIC	DIM D	PK SPEC
2	76829-0102	TIN	8.35	3.48	9.35	TRAY
4	76829-0104	TIN	12.05	2.48	13.05	
6	76829-0106	TIN	17.75	2.48	18.75	
8	76829-0108	TIN	23.45	2.48	24.45	
10	76829-0110	TIN	29.15	2.48	30.15	
12	76829-0112	TIN	34.85	2.48	35.85	
2	172065-0202	15 GOLD	8.35	3.48	9.35	
4	172065-0204	15 GOLD	12.05	2.48	13.05	
6	172065-0206	15 GOLD	17.75	2.48	18.75	
8	172065-0208	15 GOLD	23.45	2.48	24.45	
10	172065-0210	15 GOLD	29.15	2.48	30.15	
12	172065-0212	15 GOLD	34.85	2.48	35.85	
2	172065-0302	30 GOLD	8.35	3.48	9.35	
4	172065-0304	30 GOLD	12.05	2.48	13.05	
6	172065-0306	30 GOLD	17.75	2.48	18.75	
8	172065-0308	30 GOLD	23.45	2.48	24.45	
10	172065-0310	30 GOLD	29.15	2.48	30.15	
12	172065-0312	30 GOLD	34.85	2.48	35.85	

CKT SIZE	PART NO.	PLATING	DIM A	DIM C BASIC	DIM D	PK SPEC	
*	2	76829-9102	TIN	8.35	3.48	TAPE&REEL WITHOUT KAPTON	
*	4	76829-9104	TIN	12.05	2.48		13.05
*	6	76829-9106	TIN	17.75	2.48		18.75
*	8	76829-9108	TIN	23.45	2.48		24.45
*	10	76829-9110	TIN	29.15	2.48		30.15
*	12	76829-9112	TIN	34.85	2.48		35.85
*	2	172065-9202	15 GOLD	8.35	3.48		9.35
*	4	172065-9204	15 GOLD	12.05	2.48		13.05
*	6	172065-9206	15 GOLD	17.75	2.48		18.75
*	8	172065-9208	15 GOLD	23.45	2.48		24.45
*	10	172065-9210	15 GOLD	29.15	2.48		30.15
*	12	172065-9212	15 GOLD	34.85	2.48		35.85
*	2	172065-9302	30 GOLD	8.35	3.48		9.35
*	4	172065-9304	30 GOLD	12.05	2.48		13.05
*	6	172065-9306	30 GOLD	17.75	2.48		18.75
*	8	172065-9308	30 GOLD	23.45	2.48		24.45
*	10	172065-9310	30 GOLD	29.15	2.48		30.15
*	12	172065-9312	30 GOLD	34.85	2.48		35.85

CKT SIZE	PART NO.	PLATING	DIM A	DIM C BASIC	DIM D	PK SPEC	
*	2	76829-8102	TIN	8.35	3.48	TAPE&REEL WITH KAPTON	
*	4	76829-8104	TIN	12.05	2.48		13.05
*	6	76829-8106	TIN	17.75	2.48		18.75
*	8	76829-8108	TIN	23.45	2.48		24.45
*	10	76829-8110	TIN	29.15	2.48		30.15
*	12	76829-8112	TIN	34.85	2.48		35.85
*	2	172065-8202	15 GOLD	8.35	3.48		9.35
*	4	172065-8204	15 GOLD	12.05	2.48		13.05
*	6	172065-8206	15 GOLD	17.75	2.48		18.75
*	8	172065-8208	15 GOLD	23.45	2.48		24.45
*	10	172065-8210	15 GOLD	29.15	2.48		30.15
*	12	172065-8212	15 GOLD	34.85	2.48		35.85
*	2	172065-8302	30 GOLD	8.35	3.48		9.35
*	4	172065-8304	30 GOLD	12.05	2.48		13.05
*	6	172065-8306	30 GOLD	17.75	2.48		18.75
*	8	172065-8308	30 GOLD	23.45	2.48		24.45
*	10	172065-8310	30 GOLD	29.15	2.48		30.15
*	12	172065-8312	30 GOLD	34.85	2.48		35.85

\* DESIGNATES PART NOT RELEASED  
CONTACT FACTORY FOR AVAILABILITY.

THIS DRAWING CONTAINS INFORMATION THAT IS PROPRIETARY TO MOLEX ELECTRONIC TECHNOLOGIES, LLC AND SHOULD NOT BE USED WITHOUT WRITTEN PERMISSION									
DIMENSION UNITS		SCALE		CURRENT REV DESC:				<b>molex</b>	
mm		NTS							
GENERAL TOLERANCES (UNLESS SPECIFIED)				EC NO: 722781				MEGAFIT SLIM VERTICAL HEADER ASSY WITHOUT CRUSH PEGS 2-12 CKT	
ANGULAR TOL ± 3.0°				DRWN: WYATTH5 2022/10/14					
4 PLACES ±				CHK'D: XQZHANG 2022/10/27				PRODUCT CUSTOMER DRAWING	
3 PLACES ±				APPR: XQZHANG 2022/10/27					
2 PLACES ± 0.25				INITIAL REVISION:				DOCUMENT NUMBER	
1 PLACE ±				DRWN: GSHARMA 2016/07/15				768290002	
0 PLACES ±				APPR: KPRASAD 2017/07/21				PSD 000 A5	
DRAFT WHERE APPLICABLE MUST REMAIN WITHIN DIMENSIONS				THIRD ANGLE PROJECTION		DRAWING		SHEET NUMBER	
						C-SIZE		76829	
DOCUMENT STATUS				P1		RELEASE DATE		2022/10/27 06:33:11	
12		11		10		9		8	