



ABSTRACT

This user's guide presents an overview of the DLP® LightCrafter™ Display 471TP evaluation module (EVM) and a general description of the main features and functions. The document explains the first steps to getting started and shows a detailed description of onboard LEDs, connectors, and overall EVM assembly. The document provides the user a start with their first DLP LightCrafter Display 471TP evaluation module.

In addition to this document, additional reference documents are provided in [Section 2](#).

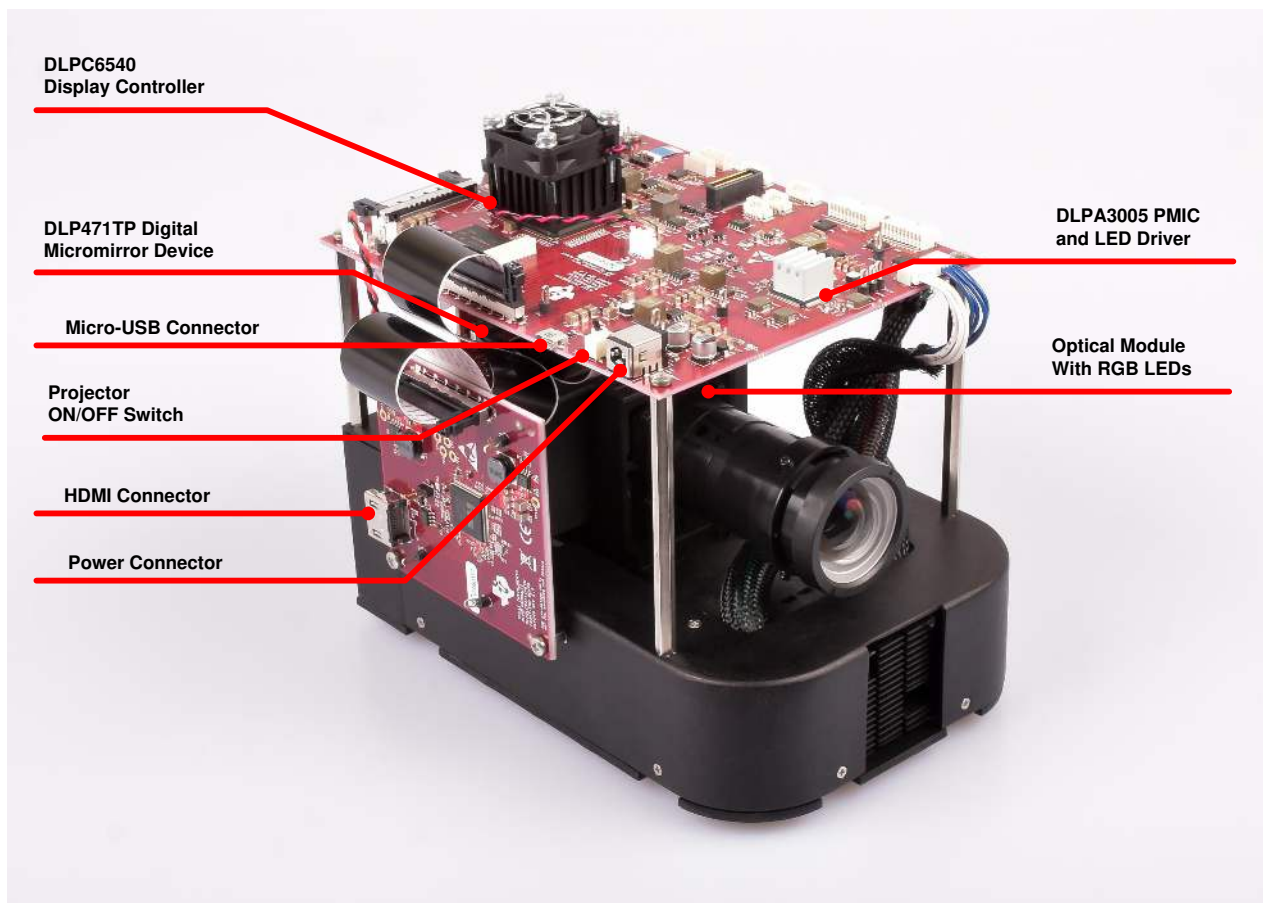

Figure 1-1. DLP LightCrafter Display Complete EVM

Table of Contents

1 Safety Instructions	3
2 Applicable Documents	4
3 DLP LightCrafter Display 471TP EVM Components	5
4 Light Engine	6
5 Quick-Start Procedure	8
6 Circuit Description	10
6.1 Connectors and Switches on Formatter Board.....	10
6.2 Connectors on Front-End Board.....	10
7 EVM Setup	11
8 Notifications	13

List of Figures

Figure 1-1. DLP LightCrafter Display Complete EVM.....	1
Figure 3-1. DLP LightCrafter Display EVM Block Diagram.....	5
Figure 4-1. Optical Engine Dimensions.....	6
Figure 4-2. Optical Engine View.....	7
Figure 5-1. Optical Engine with Focus Adjustment.....	8
Figure 7-1. DLP LightCrafter Display Front-End Board.....	11
Figure 7-2. DLP LightCrafter Display Formatter Board.....	12

List of Tables

Table 4-1. Optical Engine Specifications.....	6
Table 5-1. Status LEDs on the DLP LightCrafter Display 471TP EVM.....	9
Table 8-1. REACH Compliance SVHC Substances.....	13

Trademarks

LightCrafter™ and E2E™ are trademarks of Texas Instruments.

DLP® are registered trademarks of Texas Instruments.

All trademarks are the property of their respective owners.

1 Safety Instructions

CAUTION



Hot surface. To minimize risk of burns, do not touch.

WARNING



Possible hazardous optical radiation emitted from this product. Do not stare at the operating LEDs. May be harmful to the eye.

WARNING



Observe handling precautions. Electrostatic sensitive devices.

WARNING

Always ensure all fans are running during operation to help avoid overheating and ensure reliable operation.

2 Applicable Documents

The following documents are applicable to the DLP LightCrafter Display 471TP EVM and are available at TI.com.

1. Texas Instruments, [DLP471TP .47 4K UHD DMD](#) data sheet.
2. Texas Instruments, [DLPA3005 PMIC and High-Current LED Driver IC](#) data sheet.
3. Texas Instruments, [DLPC6540 High Resolution Display Controller](#) data sheet.
4. Texas Instruments, [DLPC6540 Software Programmer's Guide](#).
5. Texas Instruments, [DLP®LightCrafter™ Display and Light Control EVM GUI Tool](#) user's guide.

If you need additional assistance, refer to the [DLP Products and MEMS TI E2E™](#) community support forums.

3 DLP LightCrafter Display 471TP EVM Components

The DLP LightCrafter Display module consists of three subsystems:

- Light engine – Includes the optics, red, green, and blue LEDs, DMD interface board, and a DLP471TP 4K UHD DMD capable of over 500 lumens out-of-the-box.
- Formatter Board – Includes the DLP chipset comprised of a DLPC6540 controller and DLPA3005 PMIC/LED driver, USB, and power connector.
- Front-End Board – Includes the HDMI receiver and external HDMI connector.

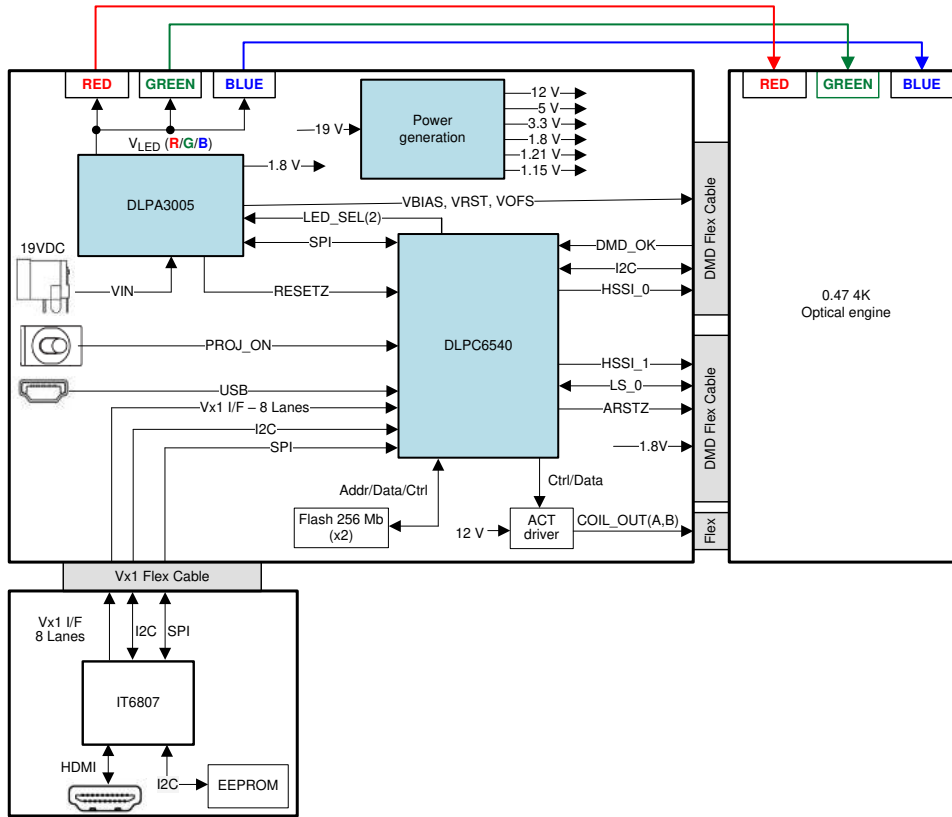

Figure 3-1. DLP LightCrafter Display EVM Block Diagram

4 Light Engine

Anhua developed the optical engine in the EVM and is production ready. The light engine consists of the following components:

- DLP471TP (0.47-inch 4K UHD DMD).
- Osram red (LE A P1MQ), green (LE CG P1AQ), and blue (LE B P1MQ) LEDs.
- This light engine interfaces with the EVM using DMD pin mapping **Option 1**. For additional DMD interface information, refer to the [DLPC6540 High Resolution Controller](#) data sheet.

Table 4-1. Optical Engine Specifications

Parameter	MIN	TYP	MAX	UNIT
Brightness at 4-A RGB LED Current		500		lm
RGB LED Current		4		A
Brightness Uniformity	85%			
Throw Ratio		1.2		
Offset		100%		
Focusable Diagonal Image Size	60		120	inch

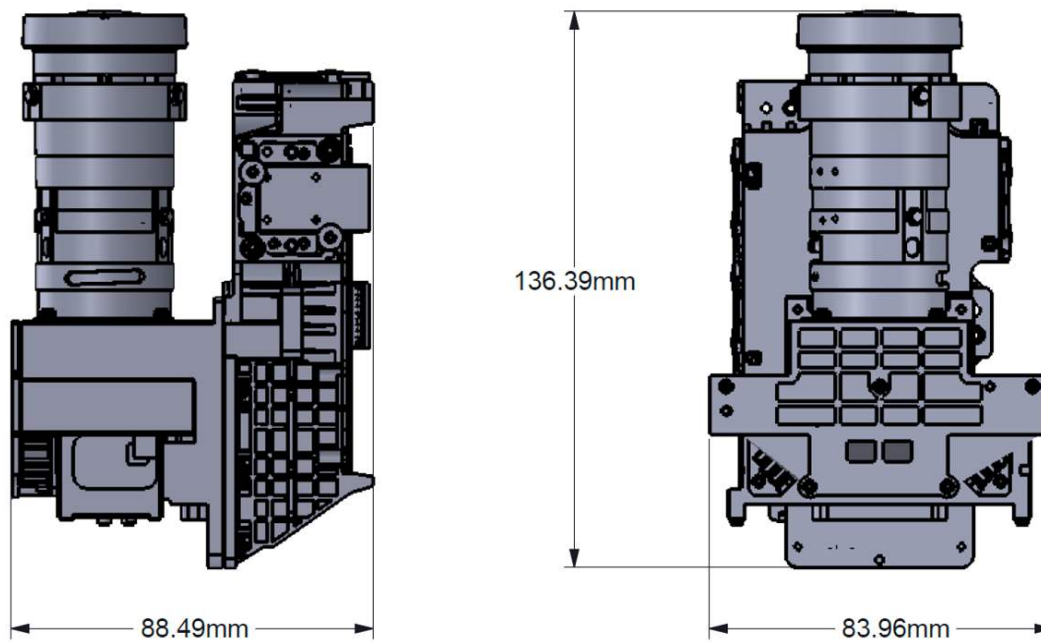

Figure 4-1. Optical Engine Dimensions

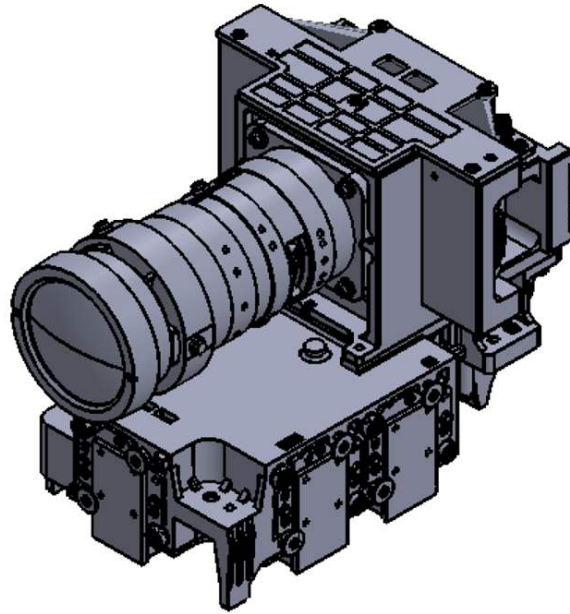

Figure 4-2. Optical Engine View

5 Quick-Start Procedure

This quick-start procedure considers default conditions as shipped.

1. Power up the DLP LightCrafter Display 471TP EVM by applying an external DC power supply (19-V DC, 4.74A) to the J1 connector.

External Power Supply Requirements:

- Nominal Output Voltage: 19 VDC
- Minimum Output Current: 2.5 A
- Maximum Output Current: 4.74 A
- Efficiency Level: VI
- Connector Barrell Size: 2.5 x 5.5 x 8.25 [ID x OD x L(min)] mm
- Connector Polarity: Center +

Note

- TI recommends using an external power supply that complies with applicable regional safety standards such as UL, CSA, VDE, CCC, and PSE.
 - The P19VIN (D3), PWRGOOD (D5) and POSENSE (D8) LEDs on the Formatter board will turn on to indicate that input and standby powers are applied.
-

1. Move SW1 switch to the ON position to turn on the DLP LightCrafter Display 471TP EVM. When the DLP LightCrafter Display 471TP EVM is turned on, the POSENSE (D8) LED will turn off and PROJ_ON LED (D7) will turn on. The HEARTBEAT LED (D8) will start blinking.
2. After the DLP LightCrafter Display 471TP EVM is turned on, the projector will default to displaying a DLP LightCrafter Display splash image.
3. The focus of the image can be adjusted manually on the optical engine.

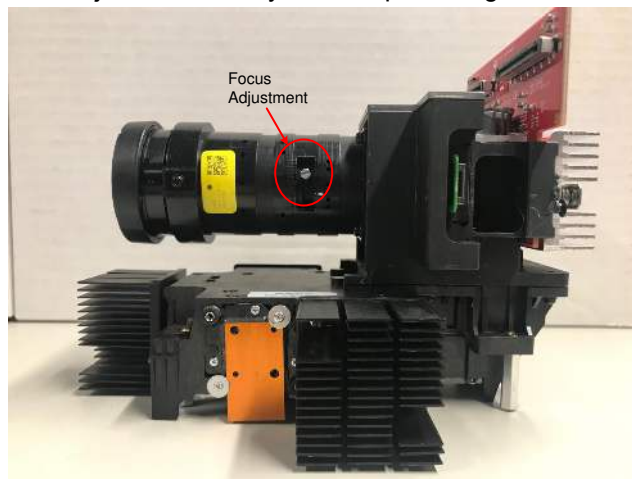

Figure 5-1. Optical Engine with Focus Adjustment

4. Connect the USB to the DLP LightCrafter Display 471TP EVM and open the latest GUI on your computer. If needed, connect an HDMI source to the EVM and communicate to the EVM via the GUI software.
5. When turning off the projector, turn off the SW1 switch prior to removing the power cable.

Note

To avoid potential damage to the DMD, it is recommended to turn off the projector with the SW1 switch before disconnecting the power.

There are eight indicator LEDs on the DLP LightCrafter Display 471TP EVM (Formatter and Front-End boards), and they are defined in [Table 5-1](#).

Table 5-1. Status LEDs on the DLP LightCrafter Display 471TP EVM

Board	LED Reference	Signal Indication	Description
Formatter	D1	LOCKN	Vx1 Interface locked.
Formatter	D3	VIN	Input 19 V power.
Formatter	D4	HEARTBEAT	BLINKING after SW1 Switched ON and ASIC is running.
Formatter	D5	PWRGOOD	ON when 19 V is applied and PMIC is up.
Formatter	D6	FAULT	Indicates ASIC SW fault has occurred.
Formatter	D7	PROJ_ON	ON when SW1 switched ON.
Formatter	D8	POSENSE	ON (Red) when 19 V power applied but PROJ_ON is still OFF.
Front-End	D4	SCDT_DR5	HDMI Input stable.

6 Circuit Description

6.1 Connectors and Switches on Formatter Board

- J1** Connector for 19-V external power supply interface.
- J2** Connector for USB cable.
- J3** Connector for Vx1 flex cable from Front-End Board.
- J4** 12-V power connector (used for EVM cooling fan).
- J5** 12-V power connector (spare).
- J6** Connector for ASIC testpoints.
- J7** DMD Interface flex cable connector (HSSI0 Bus).
- J8** 12-V power connector (used for ASIC cooling fan).
- J9** Header for BOOT_HOLD jumper
- J10** DMD Interface flex cable connector (HSSI1 Bus).
- J11** Connector for Blue LED cable.
- J12** Connector for IIC1 interface cable (spare).
- J13** Connector for Actuator Current Driver interface (not installed by default).
- J14** Header for Actuator Coil_A testpoint.
- J15** Header for Actuator Coil_B testpoint.
- J16** Connector for IIC0 interface cable (spare).
- J17** Connector for actuator flex cable.
- J18** Connector for Green LED cable.
- J19** Connector for Red LED cable.
- J20** Connector for ASIC JTAG cable.
- J21** Connector for WPC interface cable (spare).
- J22** Connector for SPI1 interface cable (spare).
- J23** Connector for UART0 interface cable (spare)
- SW1** Projector ON/OFF Switch.

6.2 Connectors on Front-End Board

- J1** HDMI input connector.
- J2** Header for EDID EEPROM programming jumper.
- J3** Connector for Vx1 flex cable to Formatter Board.

7 EVM Setup

The DLP LightCrafter Display 471TP EVM is composed of three parts:

- Front-End board
- Formatter Board
- Optical Engine with LED connections and Flex cables

The Front-End board contains the connector for the HDMI input and a flex cable connector for interfacing to Formatter board. [Figure 7-1](#) shows the main connectors on the Front-End board.

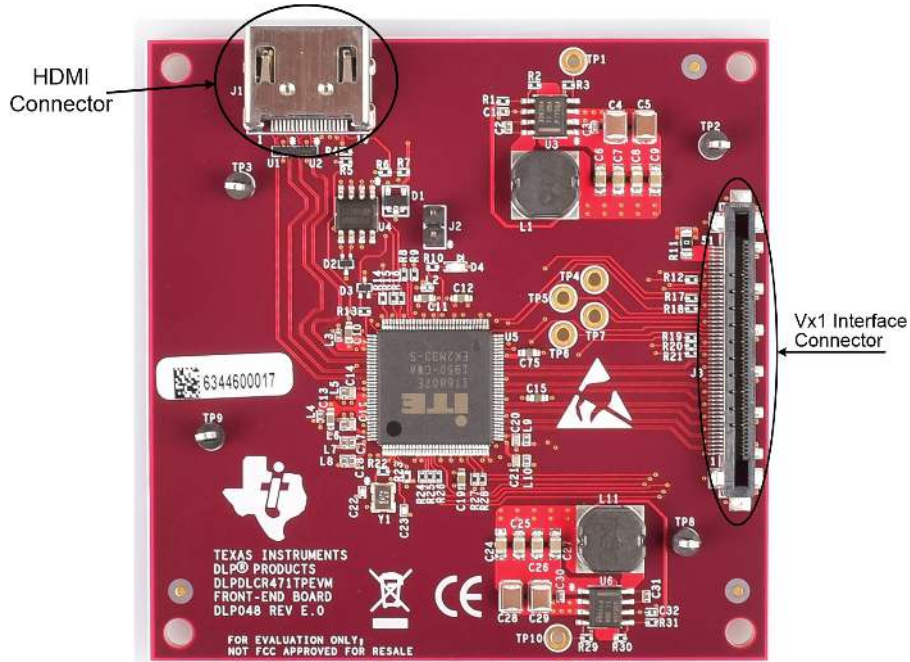

Figure 7-1. DLP LightCrafter Display Front-End Board

The Formatter board contains connector for the external power supply, a USB connector to communicate to the DLP LightCrafter Display software, the RGB LED connectors, the DMD flex cable connectors, the Front-End Board interface flex connector, and 12 V fan power connectors. The Formatter board also contains a switch to turn on the projector after external power is supplied. The connectors for each LED are labeled on the board as well as on the light engine.

Always ensure a good connection of the flex cables, power cables and LED cables to the Formatter Board before turning the EVM on.

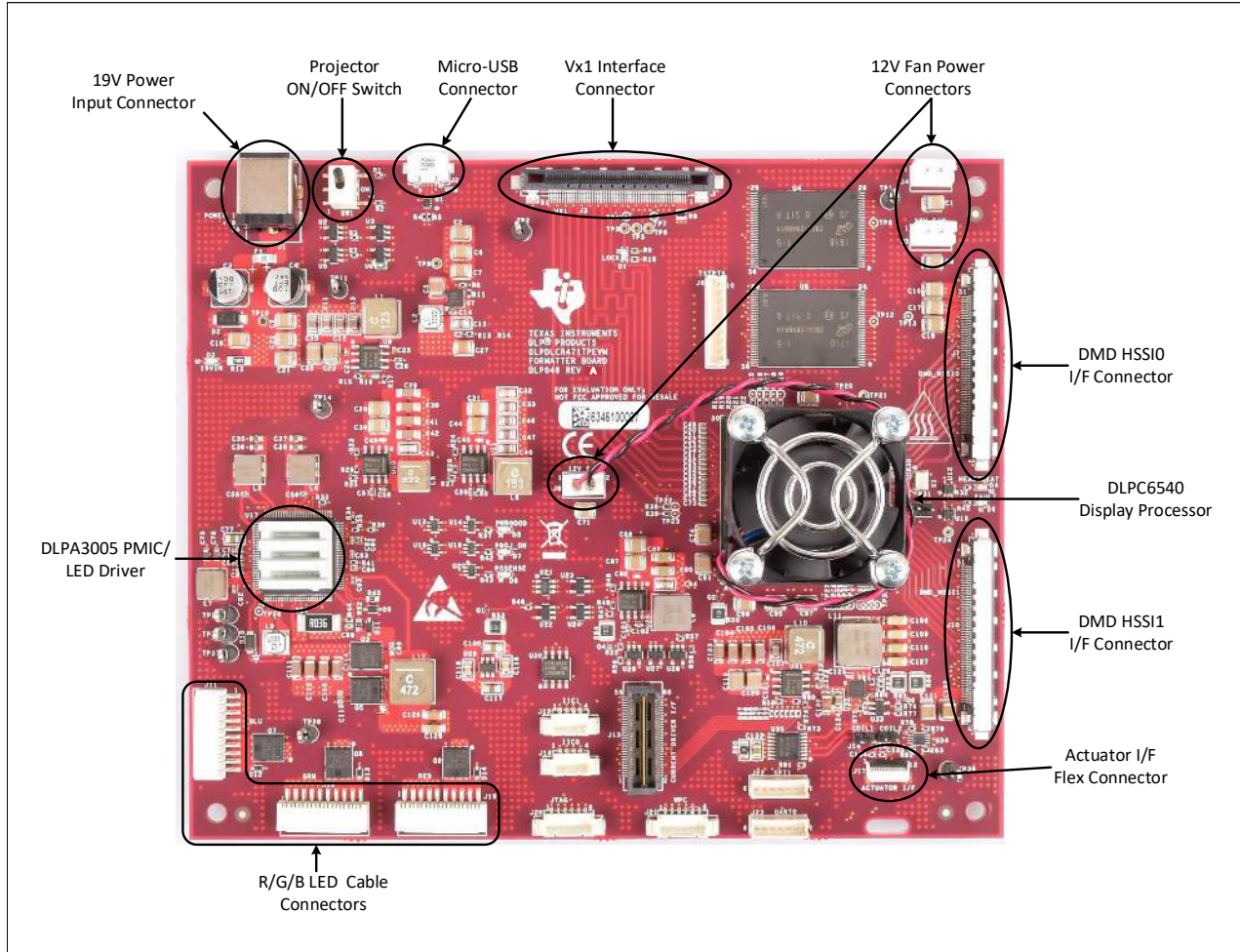

Figure 7-2. DLP LightCrafter Display Formatter Board

8 Notifications

In Compliance with Article 33 provision of the EU REACH regulation, we are notifying you that this EVM includes component(s) containing at least one Substance of Very High Concern (SVHC) above 0.1%. These uses from Texas Instruments do not exceed 1 ton per year. The SVHC's are:

Table 8-1. REACH Compliance SVHC Substances

Component Manufacturer	Component Type	Component Part Number	SVHC Substance	SVHC CAS
ITE Tech Inc.	HDMI Receiver	IT6807E/DW	4,4'-isopropylidene diphenol; Bisphenol A: BPA	80-05-7
Bourns	TVS Diode	SMAJ22A	Lead	7439-92-1
Anhua	Optical Engine	T-F16D	Diboron Trioxide	1303-86-2

IMPORTANT NOTICE AND DISCLAIMER

TI PROVIDES TECHNICAL AND RELIABILITY DATA (INCLUDING DATA SHEETS), DESIGN RESOURCES (INCLUDING REFERENCE DESIGNS), APPLICATION OR OTHER DESIGN ADVICE, WEB TOOLS, SAFETY INFORMATION, AND OTHER RESOURCES "AS IS" AND WITH ALL FAULTS, AND DISCLAIMS ALL WARRANTIES, EXPRESS AND IMPLIED, INCLUDING WITHOUT LIMITATION ANY IMPLIED WARRANTIES OF MERCHANTABILITY, FITNESS FOR A PARTICULAR PURPOSE OR NON-INFRINGEMENT OF THIRD PARTY INTELLECTUAL PROPERTY RIGHTS.

These resources are intended for skilled developers designing with TI products. You are solely responsible for (1) selecting the appropriate TI products for your application, (2) designing, validating and testing your application, and (3) ensuring your application meets applicable standards, and any other safety, security, regulatory or other requirements.

These resources are subject to change without notice. TI grants you permission to use these resources only for development of an application that uses the TI products described in the resource. Other reproduction and display of these resources is prohibited. No license is granted to any other TI intellectual property right or to any third party intellectual property right. TI disclaims responsibility for, and you will fully indemnify TI and its representatives against, any claims, damages, costs, losses, and liabilities arising out of your use of these resources.

TI's products are provided subject to [TI's Terms of Sale](#) or other applicable terms available either on ti.com or provided in conjunction with such TI products. TI's provision of these resources does not expand or otherwise alter TI's applicable warranties or warranty disclaimers for TI products.

TI objects to and rejects any additional or different terms you may have proposed.

Mailing Address: Texas Instruments, Post Office Box 655303, Dallas, Texas 75265
Copyright © 2022, Texas Instruments Incorporated