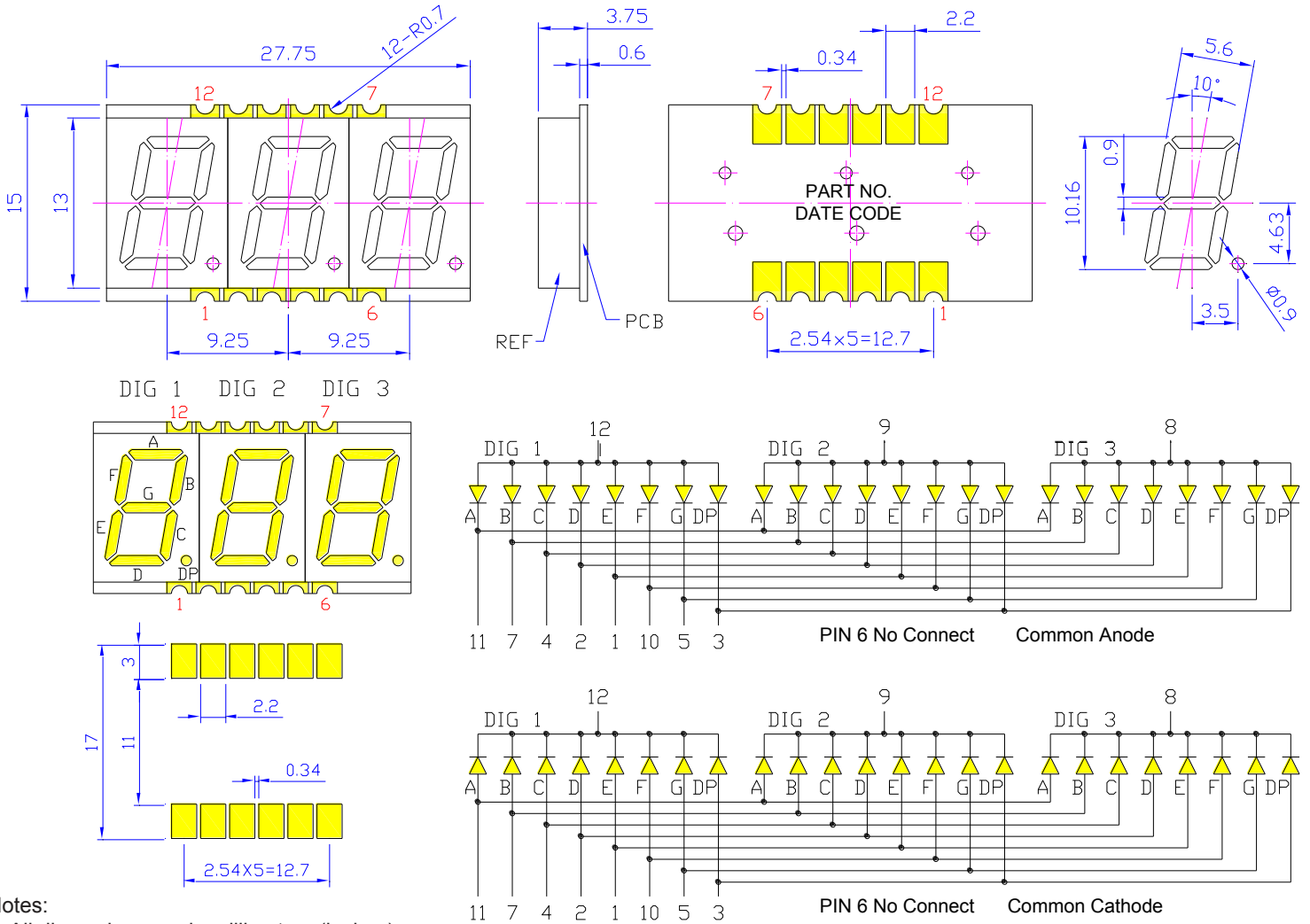


SPECIFICATIONS
SDTC40RR1W
MECHANICAL DIMENSIONS


- Notes:
1. All dimensions are in millimeters (inches).
 2. Tolerance is $\pm 0.25\text{mm}$ (0.01") unless otherwise noted.
 3. Specifications are subject to change without notice.

Part Number	Chip Material	Color of Emission	Lens Type	Description
SDTC40RR1W	AlGaAs	Red	White Segment	Common Cathode



ChromeLED Corp. reserves the right to make changes at any time in order to supply the best product possible. The most current version of this document will always be available at: www.chromeled.com

ABSOLUTE MAXIMUM RATINGS
(TA=25°C)

Parameter	Symbol	Value	Unit
Power Dissipation per Dice	P _{AD}	75	mW
Derating Liner from 25°C per Dice	-	0.42	mA / °C
Continuous Forward Current per Dice	I _{AF}	30	mA
Peak Current per Dice (duty cycle 1/10, 1kHz)	I _{PF}	200	mA
Reverse Voltage per Dice	V _R	5	V
Operating Temperature	T _{OPR}	-40~+105	°C
Storage Temperature	T _{STG}	-40~+105	°C

OPTICAL-ELECTRICAL CHARACTERISTICS
(TA=25°C)

Characteristic	Symbol	Condition	Value			Unit
			Min.	Type.	Max.	
Forward Voltage per Dice	V _F	I _F = 20mA	-	1.8	2.0	V
Reverse Current per Dice	I _R	V _R = 5V	-	-	10	μA
Peak Wavelength per Dice	λ _P	I _F = 20mA	-	655	-	nm
Dominant Wavelength per Dice	λ _D	I _F = 20mA	-	644	-	nm
Luminous Intensity per Dice	I _V	I _F = 20mA	-	20	-	mcd
Spectral Radiation Bandwidth per Dice	Δλ	I _F = 20mA	-	20	-	nm

*Tolerance of viewing angle: -10 / +5 deg.



ChromeLED Corp. reserves the right to make changes at any time in order to supply the best product possible. The most current version of this document will always be available at: www.chromeled.com

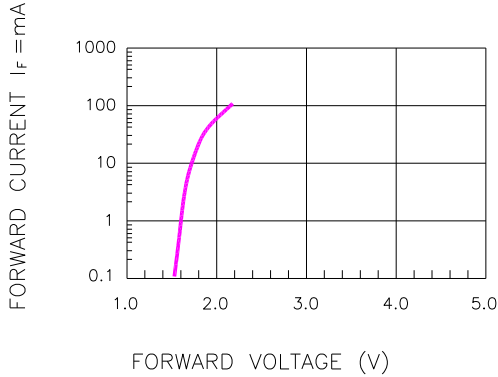
OPTICAL CHARACTERISTIC CURVES
**Typical Electro-optical Characteristic Curves
(25 °C Free Air Temperature Unless Otherwise Specified)**


Fig.1 FORWARD CURRENT VS. FORWARD VOLTAGE

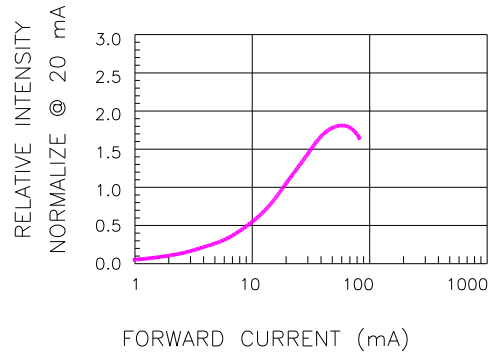


Fig.2 RELATIVE INTENSITY VS. FORWARD CURRENT

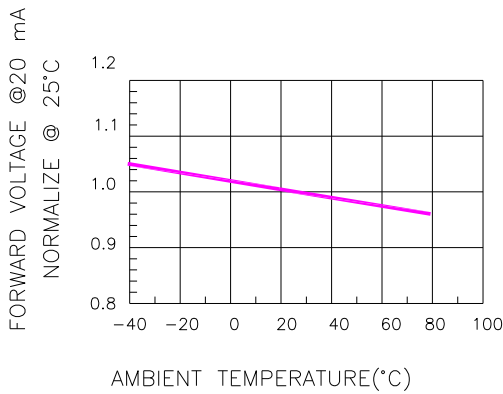


Fig.3 FORWARD VOLTAGE VS. TEMPERATURE

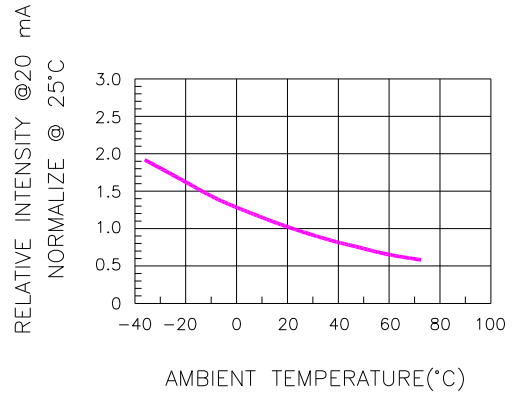


Fig.4 RELATIVE INTENSITY VS. TEMPERATURE

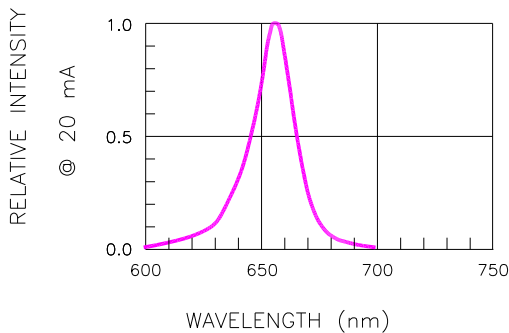


Fig.5 RELATIVE INTENSITY VS. WAVELENGTH

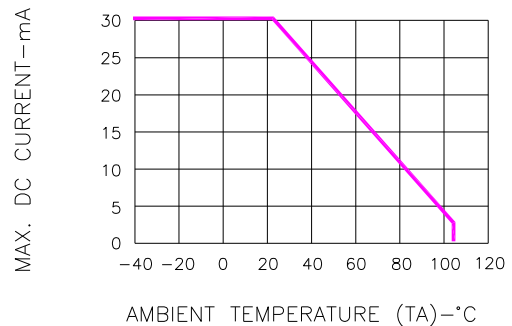


Fig.6 MAX. ALLOWABLE DC CURRENT



ChromeLED Corp. reserves the right to make changes at any time in order to supply the best product possible. The most current version of this document will always be available at: www.chromeled.com

SOLDERING CONDITIONS – LAMP TYPE LED

● **SMT REFLOW SOLDERING INSTRUCTIONS**

SMT Soldering Profile
 Pb free reflow soldering Profile



● **SOLDERING IRON**

Basic spec is ≤4 sec when 260°C. If temperature is higher, time should be shorter (+10°C→1 sec). Power dissipation of Iron should be smaller than 15W, and temperature should be controllable. Surface temperature of the device should be under 230°C.

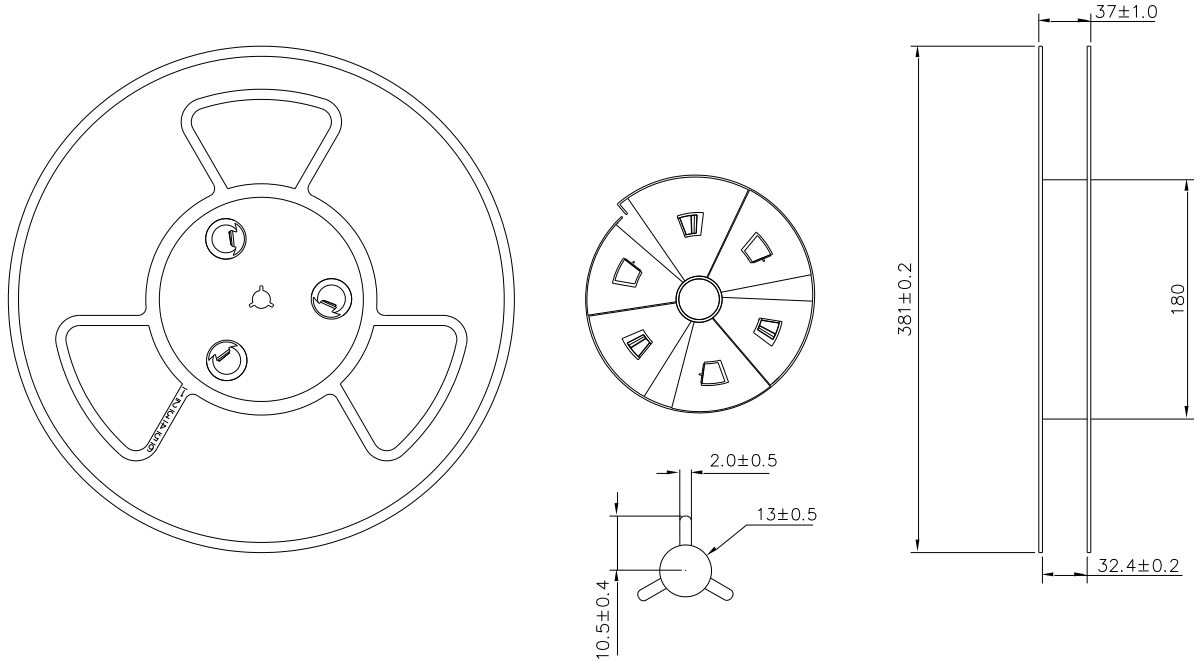
● **REWORK**

- Customer must finish rework within 5 sec. under 260°C.
- The head of soldering iron cannot touch copper foil.

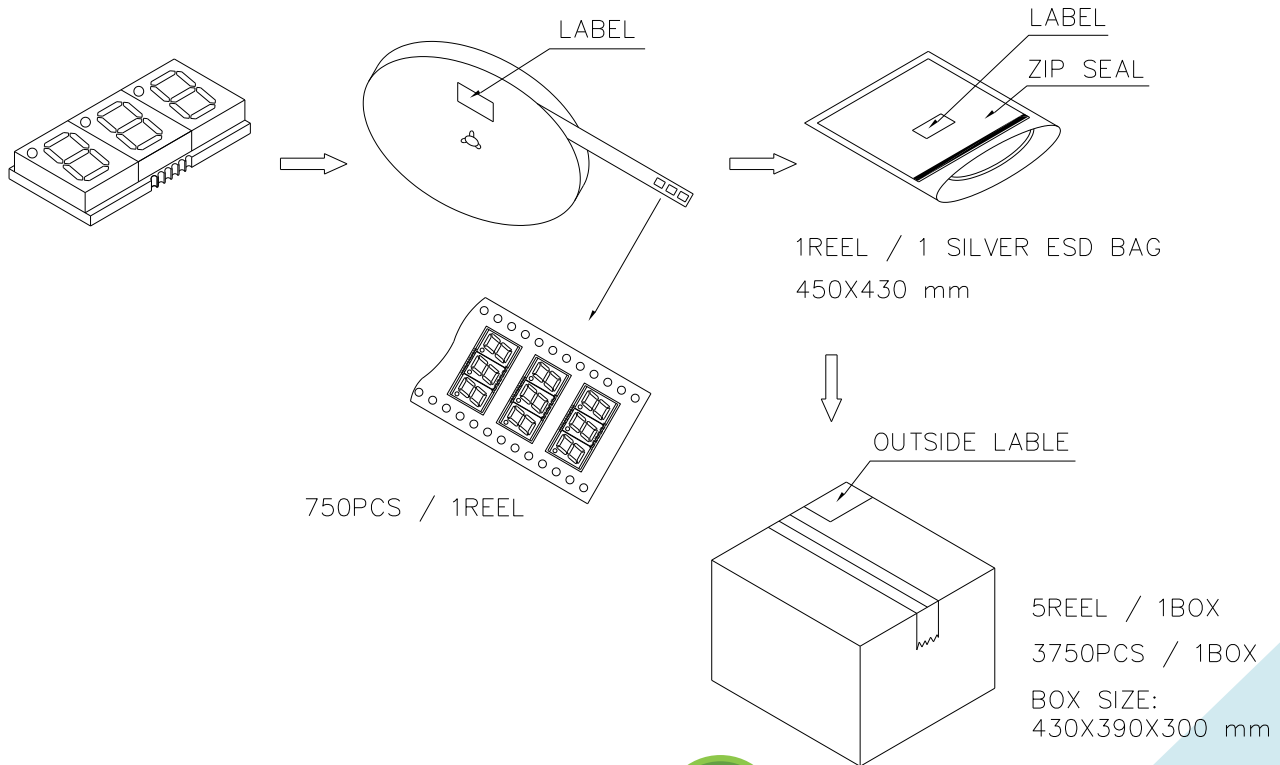


ChromeLED Corp. reserves the right to make changes at any time in order to supply the best product possible. The most current version of this document will always be available at: www.chromeled.com

DIMENSIONS OF TAPE (Unit: mm)



PACKAGING SPECIFICATION



ChromeLED Corp. reserves the right to make changes at any time in order to supply the best product possible. The most current version of this document will always be available at: www.chromeled.com