

## 650V N-Channel Super Junction MOSFET

<b>Voltage</b>	<b>650 V</b>	<b>Rdson</b>	<b>390 mΩ</b>
<b>Current</b>	<b>10 A</b>	<b>Qg</b>	<b>19 nC</b>

### Feature:

- $R_{DS(ON) Max, V_{GS}@10V}$ : 390mΩ
- Easy to use/ drive
- High Speed Switching and Low  $R_{DS(ON)}$
- 100% Avalanche Tested
- 100% Rg Tested
- Lead free in compliance with EU RoHS 2.0
- Green molding compound as per IEC 61249 standard

### Mechanical Data

- Case: ITO-220AB-F package
- Terminals: Solderable per MIL-STD-750, Method 2026
- Approx. Weight: 0.068 ounces, 2 grams

### Application

- Monitor Power, TV Power, PD Charger

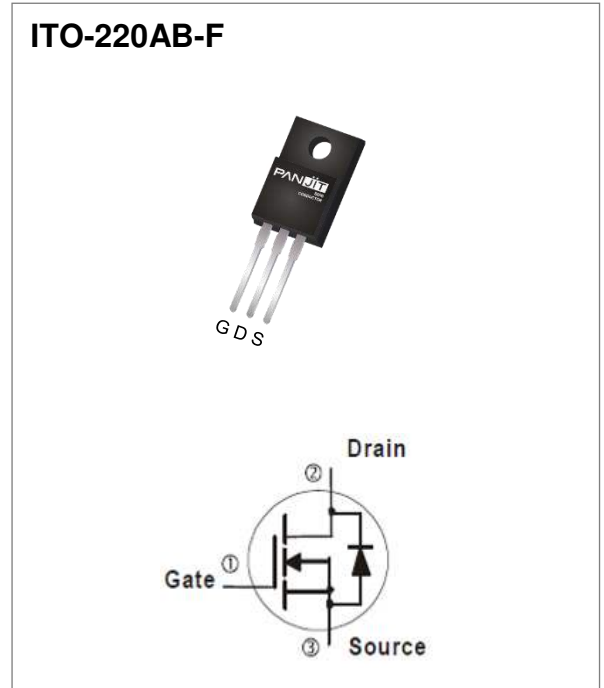

## Absolute Maximum Ratings ( $T_A = 25^\circ\text{C}$ unless otherwise specified)

PARAMETER		SYMBOL	LIMIT	UNITS
Drain-Source Voltage @ $T_{jmax}$		$V_{DS}$	700	V
Drain-Source Voltage		$V_{DS}$	650	
Gate-Source Voltage		$V_{GS}$	$\pm 30$	
Continuous Drain Current	$T_C=25^\circ\text{C}$	$I_D$	10	A
	$T_C=100^\circ\text{C}$		6.2	
Pulsed Drain Current	$T_C=25^\circ\text{C}$	$I_{DM}$	22	A
Single Pulse Avalanche Energy		$E_{AS}$	220	mJ
MOSFET dv/dt ruggedness		dv/dt	50	V/ns
Power Dissipation	$T_C=25^\circ\text{C}$	$P_D$	29.5	W
	$T_C=100^\circ\text{C}$		12	
Insulation Withstand Voltage for ITO-220AB-F		$V_{ISO}$	3.5	kV
Operating Junction and Storage Temperature Range		$T_J, T_{STG}$	-55~150	$^\circ\text{C}$

### Thermal Characteristics

PARAMETER		SYMBOL	MAXIMUM	UNITS
Thermal Resistance	Junction-to-Case	$R_{\theta JC}$	4.2	$^\circ\text{C/W}$
	Junction-to-Ambient (Note 3)	$R_{\theta JA}$	62.5	$^\circ\text{C/W}$

**Electrical Characteristics** ( $T_A = 25\text{ }^\circ\text{C}$  unless otherwise specified)

PARAMETER	SYMBOL	TEST CONDITION	MIN.	TYP.	MAX.	UNITS
<b>Static</b>						
Drain-Source Breakdown Voltage	$BV_{DSS}$	$V_{GS}=0V, I_D=250\mu A$	650	730	-	V
Gate Threshold Voltage	$V_{GS(th)}$	$V_{DS}=V_{GS}, I_D=250\mu A$	2	3.0	4	
Drain-Source On-State Resistance	$R_{DS(on)}$	$V_{GS}=10V, I_D=5.0A$ (Note 1)	-	340	390	m $\Omega$
Zero Gate Voltage Drain Current	$I_{DSS}$	$V_{DS}=650V, V_{GS}=0V$	-	-	1	$\mu A$
Gate-Source Leakage Current	$I_{GSS}$	$V_{GS}=\pm 30V, V_{DS}=0V$	-	-	$\pm 100$	nA
Transfer characteristics	gfs	$V_{DS}=20V, I_D=11A$	-	10	-	S
<b>Dynamic</b> (Note 5)						
Total Gate Charge	$Q_g$	$V_{DS}=520V, I_D=11A,$ $V_{GS}=10V$	-	19	-	nC
Gate-Source Charge	$Q_{gs}$		-	4	-	
Gate-Drain Charge	$Q_{gd}$		-	8	-	
Input Capacitance	$C_{iss}$	$V_{DS}=400V, V_{GS}=0V,$ $f=250kHz$	-	726	-	pF
Output Capacitance	$C_{oss}$		-	29	-	
Reverse Transfer Capacitance	$C_{rss}$		-	8	-	
Effective Output Capacitance Energy Related	$C_{o(er)}$	$V_{DS}=0V$ to 400V, $V_{GS}=0V, f=250kHz$ (Note 4)	-	37	-	
Turn-On Delay Time	$t_{d(on)}$	$V_{DD}=325V, I_D=11A,$ $V_{GS}=10V, R_G=25\Omega$ (Note 2)	-	30	-	ns
Turn-On Rise Time	$t_r$		-	50	-	
Turn-Off Delay Time	$t_{d(off)}$		-	87	-	
Turn-Off Fall Time	$t_f$		-	42	-	
Gate Resistance	$R_g$	$f=1.0MHz$	-	6.8	-	$\Omega$
<b>Drain-Source Diode</b>						
Maximum Continuous Drain-Source Diode Forward Current	$I_S$		-	-	10	A
Diode Forward Voltage	$V_{SD}$	$I_S=10A, V_{GS}=0V$	-	0.89	1.5	V
Reverse Recovery Charge	$Q_{rr}$	$I_S=11A$	-	3.3	-	$\mu C$
Reverse Recovery Time	$T_{rr}$	$di/dt=100A/\mu s$	-	291	-	ns

NOTES :

1. Pulse width  $\leq 300\mu s$ , Duty cycle  $\leq 2\%$
2. Essentially independent of operating temperature typical characteristics.
3.  $R_{\theta JA}$  is the sum of the junction-to-case and case-to-ambient thermal resistance.
4.  $C_{o(er)}$  is a capacitance that gives the same stored energy as  $C_{oss}$  while  $V_{DS}$  is rising from 0V to 80%  $V_{(BR)DSS}$
5. Guaranteed by design, not subject to production testing

TYPICAL CHARACTERISTIC CURVES

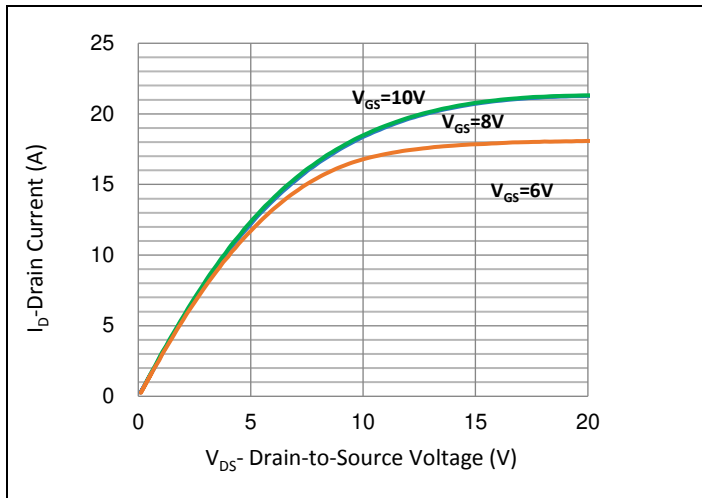

Fig.1 Output Characteristics

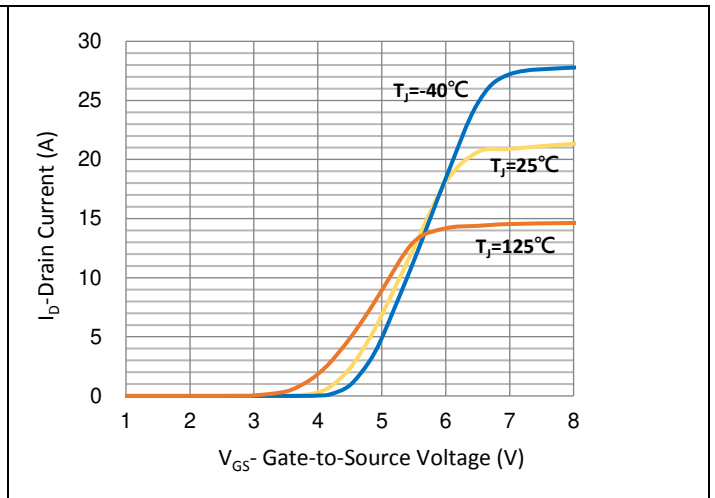

Fig.2 Transfer Characteristics

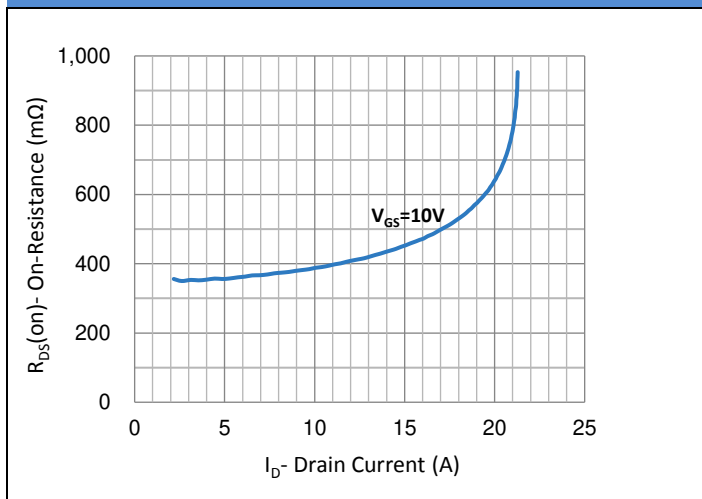

Fig.3 On-Resistance vs. Drain Current

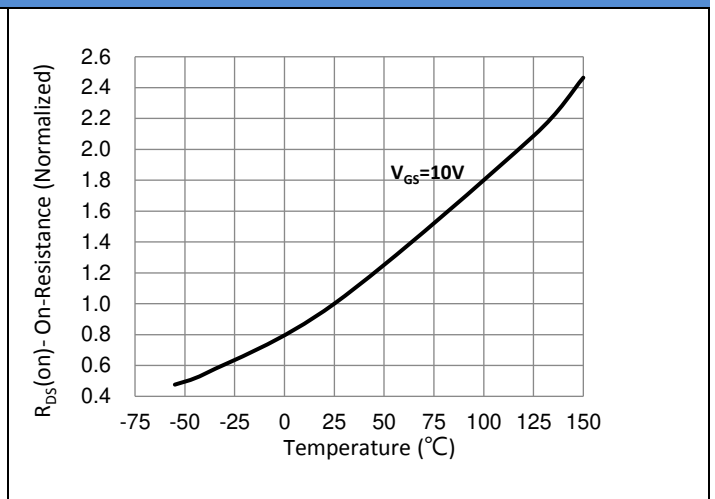

Fig.4 On-Resistance vs. Junction Temperature

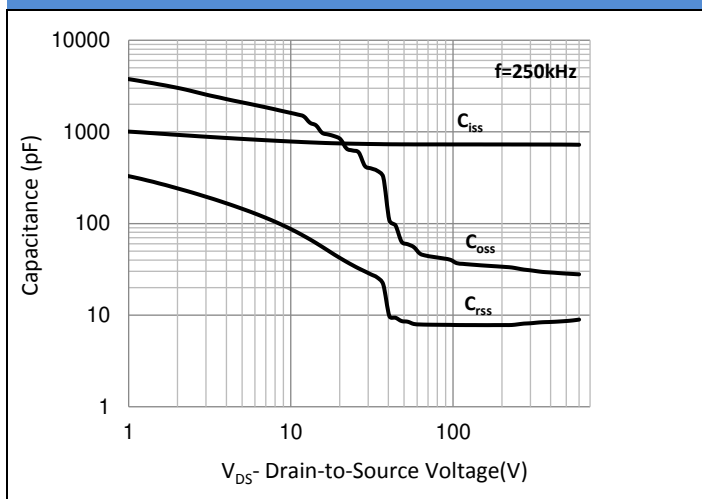

Fig.5 Capacitance vs. Drain-Source Voltage

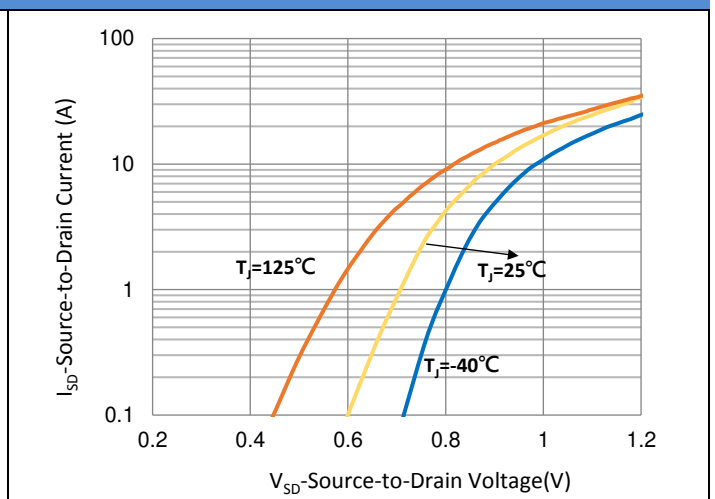

Fig.6 Source-Drain Diode Forward Voltage

TYPICAL CHARACTERISTIC CURVES

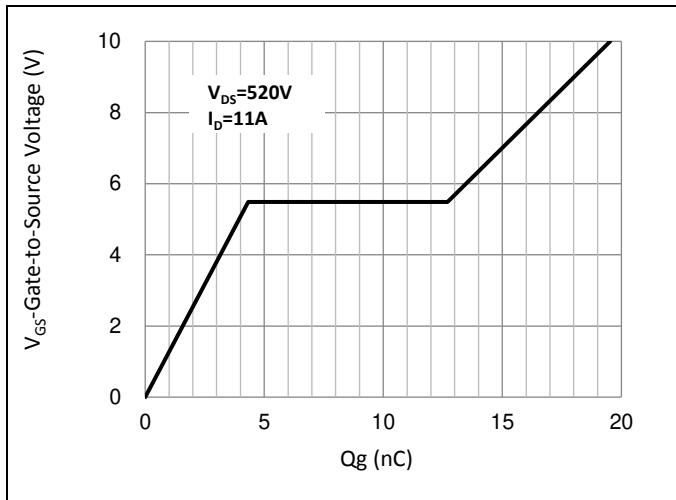

Fig.7 Gate-Charge Characteristics

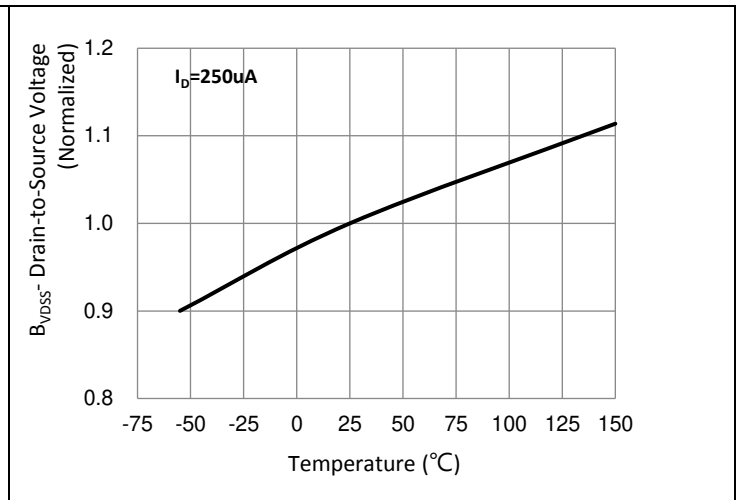

Fig.8 Breakdown Voltage Variation vs. Temperature

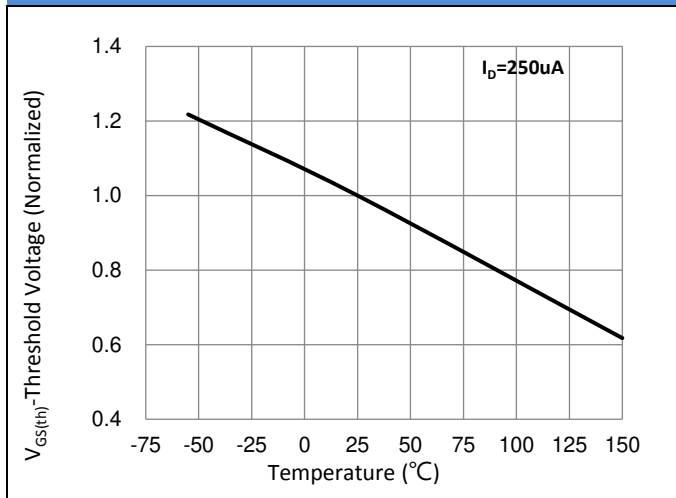

Fig.9 Threshold Voltage Variation with Temperature

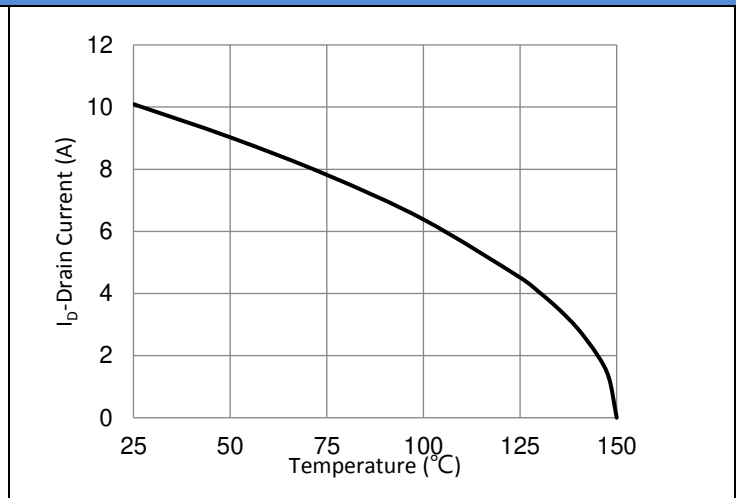

Fig.10 Drain Current vs. Case Temperature

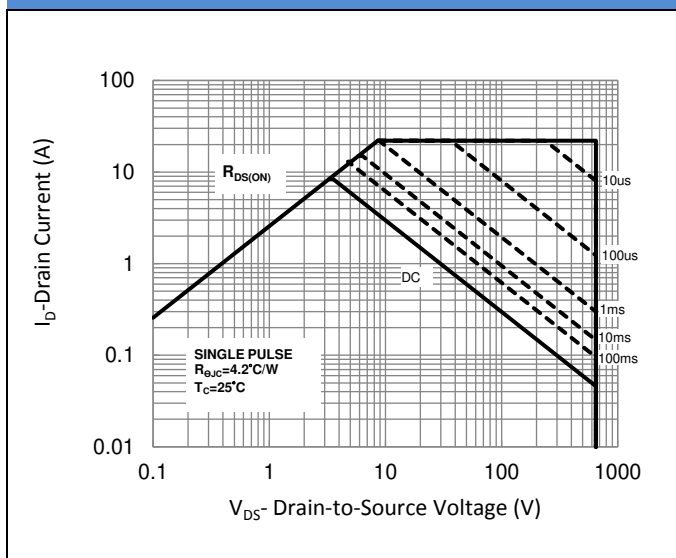

Fig.11 Maximum Safe Operating Area

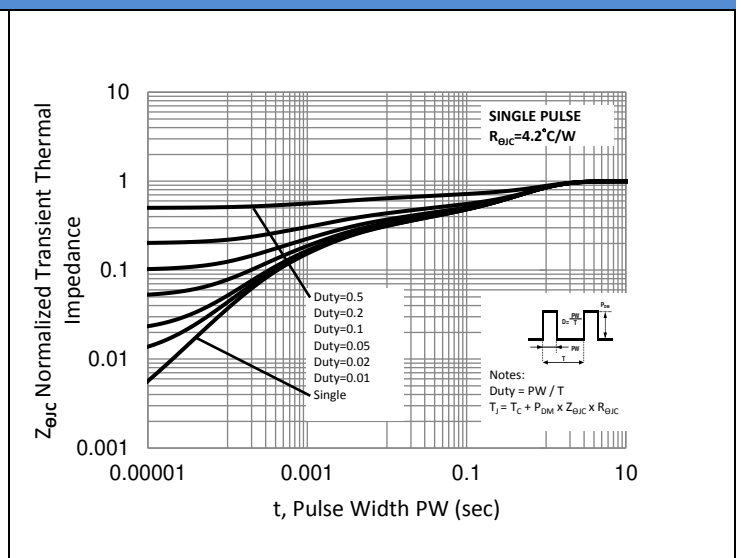

Fig.12 Normalized Transient Thermal Impedance

TYPICAL CHARACTERISTIC CURVES

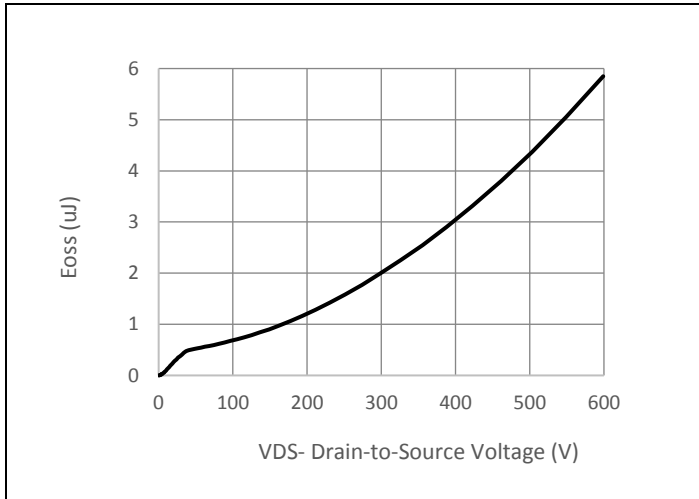
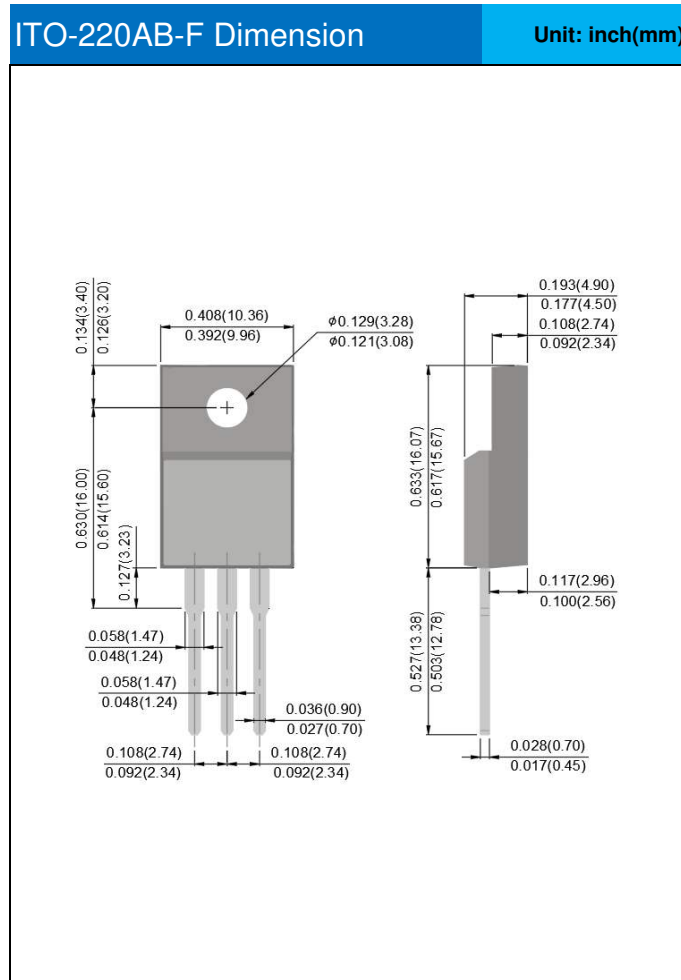

Fig.13 Typ. Coss Stored Energy

**Product and Packing Information**

Part No.	Package Type	Packing Type	Marking
PJMF390N65EC	ITO-220AB-F	50pcs / Tube	390N65EC

**Packaging Information**



**Marking Diagram**

PJ  
390N65EC  
YWLL x

- Y** = Year Code
- W** = Week Code (A~Z)
- LL** = Lot Code (00~99)
- x** = Production Line Code

## Disclaimer

- Reproducing and modifying information of the document is prohibited without permission from Panjit International Inc..
- Panjit International Inc. reserves the rights to make changes of the content herein the document anytime without notification. Please refer to our website for the latest document.
- Panjit International Inc. disclaims any and all liability arising out of the application or use of any product including damages incidentally and consequentially occurred.
- Panjit International Inc. does not assume any and all implied warranties, including warranties of fitness for particular purpose, non-infringement and merchantability.
- Applications shown on the herein document are examples of standard use and operation. Customers are responsible in comprehending the suitable use in particular applications. Panjit International Inc. makes no representation or warranty that such applications will be suitable for the specified use without further testing or modification.
- The products shown herein are not designed and authorized for equipments requiring high level of reliability or relating to human life and for any applications concerning life-saving or life-sustaining, such as medical instruments, transportation equipment, aerospace machinery et cetera. Customers using or selling these products for use in such applications do so at their own risk and agree to fully indemnify Panjit International Inc. for any damages resulting from such improper use or sale.
- Since Panjit uses lot number as the tracking base, please provide the lot number for tracking when complaining.