

GlobTek, Inc. www.globtek.com 186 Veterans Drive, Northvale, NJ 07647 Tel. (201) 784-1000 Fax (201) 784-0111	Drawing Title: GT-86060-0505-W2E, ICT/ITE Power Supply, Efficiency Level: USA DOE Level VI / Eco-design Directive 2009/125/EC, (EU) 2019/1782, Case Color/Style: GlobTek Black, Wall Plug-in, Regulated Switchmode AC-DC Power Supply AC Adaptor, Input Rating: 100-240V~, 50/60Hz, Euro Plug Fixed , Output Rating: 5W, 5.0V@1.0A, Output Configuration: 1500 mm, 22/2 Cond, UL 2468, Female Barrel 5.5*2.1*11mm w/ Spring Clip & Locking Notch or Equal, Ferrite: None, GlobTek Black, GT Cord # C16707, Pin Out: Center Positive (+V), symbol compliant with IEC 60417 symbol no. 5926, Blades/Input Cord: Fixed Blades European CEE 7/16 2 Conductor, Approvals: EAC; Morocco; WEEE; Double Insulation; CB 62368; CE; RoHS; China RoHS; LPS 60950; Ukraine; CB 60950;	
	Model No. GT-86060-0505-W2E	
	Part No./Ordering No. WR9MA1200CCP-F(R6B)	Rev D

In Addition to GlobTek Inc.'s renewed ISO9001:2015 - Quality Management System Certification, GlobTek Inc. is now certified to:

ISO13485:2016 - Medical Devices Quality Management System Certification

ISO14001:2015 - Environmental Management System Certification

ISO Certificates are available online at <https://www.globtek.com/iso-certificates/>

The acceptance of this specification and use of the product described in this document indicates the acceptance and binding of the customer to Globtek TERMS AND CONDITIONS (attached to the end of this document), which supersede all other agreements, terms, and conditions (<https://en.globtek.com/terms-and-conditions/>).

The purchaser of this product (Customer) agrees that it is their sole responsibility to determine suitability/fitness of the product described in this specification for their application and to take precautions for protection against any hazards attendant to the handling and use of the product.

Footnote:

GlobTek Inc. will not be liable for the safety and performance of these power supplies/battery packs if unauthorized access and repair occurs. End user should consult applicable UL, CSA or EN standards for proper installation instruction.

Limitation of Use:

GlobTek products are intended for use with commercial, medical, and/or industrial equipment only. GlobTek product are not authorized for use as mission critical components in life support hazardous environment, nuclear or aircraft applications without prior written approval from the CEO of GlobTek Inc.

Contents of this document are subject to change without prior notice.

Customer Approval of Specification:

Please approve, sign and send back to GlobTek so we can complete order processing.

A delay in receipt of this form will delay delivery schedule.

Company Name: _____	Customer P/N: _____
Quote Number: _____	Date: _____
Authorized Representative Name: _____	Authorized Representative Signature: _____

GlobTek, Inc. www.globtek.com 186 Veterans Drive, Northvale, NJ 07647 Tel. (201) 784-1000 Fax (201) 784-0111	Drawing Title: GT-86060-0505-W2E, ICT/ITE Power Supply, Efficiency Level: USA DOE Level VI / Eco-design Directive 2009/125/EC, (EU) 2019/1782, Case Color/Style: GlobTek Black, Wall Plug-in, Regulated Switchmode AC-DC Power Supply AC Adaptor, Input Rating: 100-240V~, 50/60Hz, Euro Plug Fixed , Output Rating: 5W, 5.0V@1.0A, Output Configuration: 1500 mm, 22/2 Cond, UL 2468, Female Barrel 5.5*2.1*11mm w/ Spring Clip & Locking Notch or Equal, Ferrite: None, GlobTek Black, GT Cord # C16707, Pin Out: Center Positive (+V), symbol compliant with IEC 60417 symbol no. 5926, Blades/Input Cord: Fixed Blades European CEE 7/16 2 Conductor, Approvals: EAC; Morocco; WEEE; Double Insulation; CB 62368; CE; RoHS; China RoHS; LPS 60950; Ukraine; CB 60950;	
	Model No. GT-86060-0505-W2E	
	Part No./Ordering No. WR9MA1200CCP-F(R6B)	Rev D

REVISION HISTORY

REV	DESCRIPTION	SUB	DATE	APPROVED
D	Add note about ESD requirement	dhock	11/22/2018	QA
C	Update output cord	rchiu	11/08/2017	QA
B	Update packaging Update output cord from 20AWG to 22AWG	rchiu	11/06/2017	QA
A	Initial release	dhock	08/25/2017	QA

POWER SUPPLY INFORMATION

TYPE	Wall Plug-in
TECHNOLOGY	Regulated Switchmode AC-DC Power Supply AC Adaptor
CASE COLOR	GlobTek Black
NAMEPLATE RATED INPUT	100-240V~, 50/60Hz, 0.2A
INPUT CONFIG	Euro Plug Fixed
WATTS	5.00
VOLTS OUT	5.0
CURRENT OUT (Amps)	1.0
BLADE/CORD INCLUDED	FBEuro2 Fixed Blades European CEE 7/16 2 Conductor
BLADE/CORD INSTALLED	FBEuro2 :Fixed Blades European CEE 7/16 2 Conductor
INGRESS PROTECTION	IPX0
GROUNDING CONFIGURATION	(F1) Class II / Double Insulated
EFFICIENCY LEVEL	USA DOE Level VI / Eco-design Directive 2009/125/EC, (EU) 2019/1782
OUTPUT CONFIGURATION	1500 mm, 22/2 Cond, UL 2468, Female Barrel 5.5*2.1*11mm w/ Spring Clip & Locking Notch or Equal, Ferrite: None, GlobTek Black, GT Cord # C16707
OVERMOLDED	Yes
OUTPUT CONNECTOR GENDER	Female
CONNECTOR PIN OUT	Center Positive (+V), symbol compliant with IEC 60417 symbol no. 5926
LABEL SPECS	Standard GT,L-1186
SPECIAL BARCODE LABEL MATERIAL	No
PACK SPEC	Standard WPI non changeable, Individually Box, User manual
USER MANUAL	809-DESKTOPUSERMANUAL on A4 paper

PROPRIETARY INFORMATION

PROPRIETARY OF GLOBTEK, INC. ANY REPRODUCTION, DISCLOSURE OR USE OF THIS DRAWING, IN WHOLE OR IN PART, IS HEREBY PROHIBITED EXCEPT AS SPECIFIED IN WRITING BY GLOBTEK, INC. © GlobTek, Inc. 2016 - 2023

GlobTek, Inc. www.globtek.com 186 Veterans Drive, Northvale, NJ 07647 Tel. (201) 784-1000 Fax (201) 784-0111	Drawing Title: GT-86060-0505-W2E, ICT/ITE Power Supply, Efficiency Level: USA DOE Level VI / Eco-design Directive 2009/125/EC, (EU) 2019/1782, Case Color/Style: GlobTek Black, Wall Plug-in, Regulated Switchmode AC-DC Power Supply AC Adaptor, Input Rating: 100-240V~, 50/60Hz, Euro Plug Fixed , Output Rating: 5W, 5.0V@1.0A, Output Configuration: 1500 mm, 22/2 Cond, UL 2468, Female Barrel 5.5*2.1*11mm w/ Spring Clip & Locking Notch or Equal, Ferrite: None, GlobTek Black, GT Cord # C16707, Pin Out: Center Positive (+V), symbol compliant with IEC 60417 symbol no. 5926, Blades/Input Cord: Fixed Blades European CEE 7/16 2 Conductor, Approvals: EAC; Morocco; WEEE; Double Insulation; CB 62368; CE; RoHS; China RoHS; LPS 60950; Ukraine; CB 60950;	
	Model No. GT-86060-0505-W2E	
	Part No./Ordering No. WR9MA1200CCP-F(R6B)	Rev D

Notes/Modifications/Customizations (notes in this section supersede the values shown in the standard spec)

DIMENSIONS ARE IN MM UNLESS SPECIFIED OTHERWISE

Complies with ESD requirement: IEC61340-5-1 ±6KV contact; ±8KV air discharge

GloTek, Inc. www.globtek.com 186 Veterans Drive, Northvale, NJ 07647 Tel. (201) 784-1000 Fax (201) 784-0111	Drawing Title: GT-86060-0505-W2E, ICT/ITE Power Supply, Efficiency Level: USA DOE Level VI / Eco-design Directive 2009/125/EC, (EU) 2019/1782, Case Color/Style: GlobTek Black, Wall Plug-in, Regulated Switchmode AC-DC Power Supply AC Adaptor, Input Rating: 100-240V~, 50/60Hz, Euro Plug Fixed, Output Rating: 5W, 5.0V@1.0A, Output Configuration: 1500 mm, 22/2 Cond, UL 2468, Female Barrel 5.5*2.1*11mm w/ Spring Clip & Locking Notch or Equal, Ferrite: None, GlobTek Black, GT Cord # C16707, Pin Out: Center Positive (+V), symbol compliant with IEC 60417 symbol no. 5926, Blades/Input Cord: Fixed Blades European CEE 7/16 2 Conductor, Approvals: EAC; Morocco; WEEE; Double Insulation; CB 62368; CE; RoHS; China RoHS; LPS 60950; Ukraine; CB 60950;	
	Model No. GT-86060-0505-W2E	
	Part No./Ordering No. WR9MA1200CCP-F(R6B)	Rev D

ELECTRICAL SPECIFICATIONS

A) ELECTRICAL SPECIFICATIONS:

01. Input Voltage: Specified 90-264 Vac, Nameplate rated: 100-240Vac
02. Input Frequency: Specified 47-63 Hz, Nameplate rated 50-60Hz
03. Output Regulation: +/- 5%
04. Ripple and Noise (Vp-p): 250 mVp-p maximum, At 20 MHz, and output parallel with 0.1uF & 47uF capacitors to ground. Temperature at 25 °C, and nominal input voltage
05. Efficiency: Compliant with Efficiency Level VI and ErP European Commission's Ecodesign Directive (2005/32/EC) / CoC Tier 2 Compliant
06. No Load Standby Power: <0.075W @ 230Vac
07. Turn-ON Delay: 3 Seconds maximum at nominal input voltage
08. Rise Time: 100mS maximum at nominal input voltage

B) PROTECTION

01. Over-Voltage
02. Over current protection
03. Short Circuit: Short circuit protection is to be included in the construction of the adaptor. The adaptor is designed to withstand continuous current of a short circuit on the output. The adaptor will be short circuit tolerant for an indefinite period.

C) SAFETY

01. Dielectric Withstand Voltage: Primary To Secondary: 3000VAC 10mA 1minute or 4242VDC 10mA 1minute
02. Touch Current: Did not exceed 100uA NC(Normal condition) 500uA SFC(single fault condition)

D) EMC

01. Emissions, per EN 55032, EN 61000-6-3, EN 61000-6-4
 - Conducted Emissions: Class B, FCC Part 15, Class B
 - Radiated Emissions: Class B, FCC Part 15, Class B
02. Line Frequency Harmonics EN61000-3-2, Class A
03. Voltage Fluctuations/Flicker EN61000-3-3
04. Immunity, per EN 55024, EN 61000-6-1, EN 61000-6-2
 - Static Discharge Immunity EN61000-4-2, 4kV Contact Discharge, 8kV air discharge
 - Radiated RF Immunity EN61000-4-3, 3V/m 80-1000MHz, 80% 1KHz AM.
 - EFT/Burst Immunity EN61000-4-4, 1kV/100kHz.
 - Line Surge Immunity EN61000-4-5, 1kV differential, 2kV common-mode
 - Conducted RF Immunity EN61000-4-6, 3Vrms, 80% 1KHz AM
 - Power Frequency Magnetic Field Immunity EN61000-4-8, 1A/m
 - Voltage Dip Immunity EN61000-4-11, Criteria

E) OTHER:

01. MTBF: 200,000 Hours @ 25°C ambient temperature
02. Operating Temperature: 0°C to 40°C ambient temperature
03. Humidity: 0% to 90% relative humidity
04. Storage Temperature: -10°C to 80°C
05. Cooling: natural convection cooling
06. ROHS 2: Complies with EU 2011/65/EU and China SJ/T 11363-2006

F) ENCLOSURE

PROPRIETARY INFORMATION

PROPRIETARY OF GLOBTEK, INC. ANY REPRODUCTION, DISCLOSURE OR USE OF THIS DRAWING, IN WHOLE OR IN PART, IS HEREBY PROHIBITED EXCEPT AS SPECIFIED IN WRITING BY GLOBTEK, INC. © GlobTek, Inc. 2016 - 2023

quest / 07/27/2023 11:56:52 AM GMT

GlobTek, Inc. www.globtek.com 186 Veterans Drive, Northvale, NJ 07647 Tel. (201) 784-1000 Fax (201) 784-0111	Drawing Title: GT-86060-0505-W2E, ICT/ITE Power Supply, Efficiency Level: USA DOE Level VI / Eco-design Directive 2009/125/EC, (EU) 2019/1782, Case Color/Style: GlobTek Black, Wall Plug-in, Regulated Switchmode AC-DC Power Supply AC Adaptor, Input Rating: 100-240V~, 50/60Hz, Euro Plug Fixed , Output Rating: 5W, 5.0V@1.0A, Output Configuration: 1500 mm, 22/2 Cond, UL 2468, Female Barrel 5.5*2.1*11mm w/ Spring Clip & Locking Notch or Equal, Ferrite: None, GlobTek Black, GT Cord # C16707, Pin Out: Center Positive (+V), symbol compliant with IEC 60417 symbol no. 5926, Blades/Input Cord: Fixed Blades European CEE 7/16 2 Conductor, Approvals: EAC; Morocco; WEEE; Double Insulation; CB 62368; CE; RoHS; China RoHS; LPS 60950; Ukraine; CB 60950;	
	Model No. GT-86060-0505-W2E	
	Part No./Ordering No. WR9MA1200CCP-F(R6B)	Rev D

- 01. Housing: High impact plastic, 94V0 polycarbonate, non-vented
- 02. Markings: Label and/or Pad Printed and/or Molded in the case

TO ADDRESS SYSTEM-LEVEL EMI CONCERNS, FERRITE CHOKES/BEADS MAY BE ADDED/REVISED UPON REQUEST. A SAMPLE KIT OF GLOBTEK'S STANDARD FERRITES IS AVAILABLE UNDER GLOBTEK P/N: EMI-MITIGATION-KIT1

FOR ADDITIONAL INFORMATION, PLEASE READ OUR WHITE PAPER AT: <https://r.globtek.info/3QeaqtD>

INGRESS PROTECTION: IPX0

GlobTek, Inc.
www.globtek.com
186 Veterans Drive,
Northvale, NJ 07647
Tel. (201) 784-1000
Fax (201) 784-0111

Drawing Title: GT-86060-0505-W2E, ICT/ITE Power Supply, Efficiency Level: USA DOE Level VI / Eco-design Directive 2009/125/EC, (EU) 2019/1782, Case Color/Style: GlobTek Black, Wall Plug-in, Regulated Switchmode AC-DC Power Supply AC Adaptor, Input Rating: 100-240V~, 50/60Hz, Euro Plug Fixed , Output Rating: 5W, 5.0V@1.0A, Output Configuration: 1500 mm, 22/2 Cond, UL 2468, Female Barrel 5.5*2.1*11mm w/ Spring Clip & Locking Notch or Equal, Ferrite: None, GlobTek Black, GT Cord # C16707, Pin Out: Center Positive (+V), symbol compliant with IEC 60417 symbol no. 5926, Blades/Input Cord: Fixed Blades European CEE 7/16 2 Conductor, Approvals: EAC; Morocco; WEEE; Double Insulation; CB 62368; CE; RoHS; China RoHS; LPS 60950; Ukraine; CB 60950;

Model No. GT-86060-0505-W2E

Part No./Ordering No. WR9MA1200CCP-F(R6B)

Rev D

3D File Download https://www.globtek.com/dl/GT_86060_06VV_W2E_EU_asm.stp

Mechanical drawing

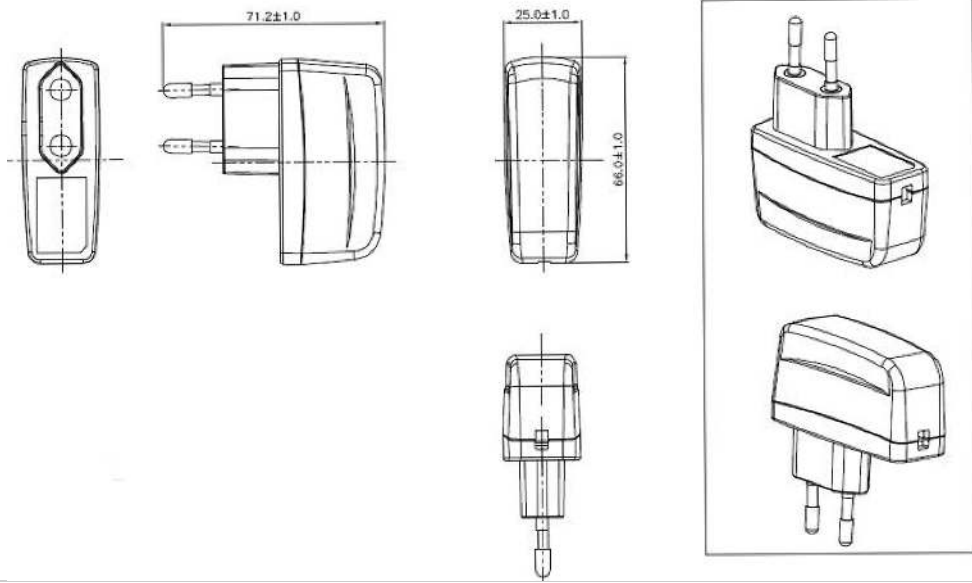

GlobTek, Inc.
 www.globtek.com
 186 Veterans Drive,
 Northvale, NJ 07647
 Tel. (201) 784-1000
 Fax (201) 784-0111

Drawing Title: GT-86060-0505-W2E, ICT/ITE Power Supply, Efficiency Level: USA DOE Level VI / Eco-design Directive 2009/125/EC, (EU) 2019/1782, Case Color/Style: GlobTek Black, Wall Plug-in, Regulated Switchmode AC-DC Power Supply AC Adaptor, Input Rating: 100-240V~, 50/60Hz, Euro Plug Fixed, Output Rating: 5W, 5.0V@1.0A, Output Configuration: 1500 mm, 22/2 Cond, UL 2468, Female Barrel 5.5*2.1*11mm w/ Spring Clip & Locking Notch or Equal, Ferrite: None, GlobTek Black, GT Cord # C16707, Pin Out: Center Positive (+V), symbol compliant with IEC 60417 symbol no. 5926, Blades/Input Cord: Fixed Blades European CEE 7/16 2 Conductor, Approvals: EAC; Morocco; WEEE; Double Insulation; CB 62368; CE; RoHS; China RoHS; LPS 60950; Ukraine; CB 60950;

Model No. GT-86060-0505-W2E

Part No./Ordering No. WR9MA1200CCP-F(R6B) Rev D

DERATING CURVE

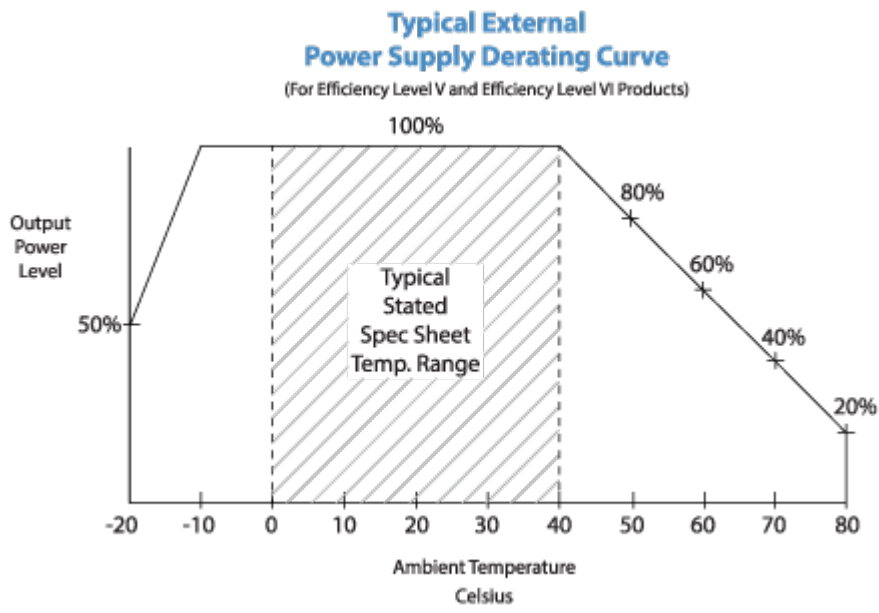

GlobTek, Inc. www.globtek.com 186 Veterans Drive, Northvale, NJ 07647 Tel. (201) 784-1000 Fax (201) 784-0111	Drawing Title: GT-86060-0505-W2E, ICT/ITE Power Supply, Efficiency Level: USA DOE Level VI / Eco-design Directive 2009/125/EC, (EU) 2019/1782, Case Color/Style: GlobTek Black, Wall Plug-in, Regulated Switchmode AC-DC Power Supply AC Adaptor, Input Rating: 100-240V~, 50/60Hz, Euro Plug Fixed , Output Rating: 5W, 5.0V@1.0A, Output Configuration: 1500 mm, 22/2 Cond, UL 2468, Female Barrel 5.5*2.1*11mm w/ Spring Clip & Locking Notch or Equal, Ferrite: None, GlobTek Black, GT Cord # C16707, Pin Out: Center Positive (+V), symbol compliant with IEC 60417 symbol no. 5926, Blades/Input Cord: Fixed Blades European CEE 7/16 2 Conductor, Approvals: EAC; Morocco; WEEE; Double Insulation; CB 62368; CE; RoHS; China RoHS; LPS 60950; Ukraine; CB 60950;
	Model No. GT-86060-0505-W2E
	Part No./Ordering No. WR9MA1200CCP-F(R6B) Rev D

INPUT CONFIGURATION

(F1) Class II / Double Insulated

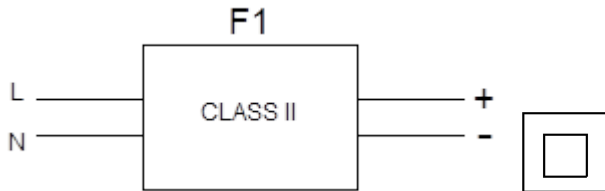

[Alternate grounding configurations](#) available upon request.

Blades/Cord Included: FBEuro2: Fixed Blades European CEE 7/16 2 Conductor

Blades/Cord Installed: FBEuro2: Fixed Blades European CEE 7/16 2 Conductor

European CEE 7/16 configuration: EN 50075 Europlug 2 PIN

The prongs of the Europlug are 19 mm long. They consist of a 9 mm long conductive tip of 4 mm diameter with a rounded ending, followed by a 10 mm long flexible insulated shaft of not more than 3.8 mm diameter. The two prongs are not exactly parallel and converge slightly; their centres are 19 mm apart at the tip and 18.6 mm apart at the base. The elasticity of the converging prongs provides sufficient contact force for the Europlug's current rating with a variety of socket-hole arrangements. The entire plug is 35.3 mm wide and 13.7 mm high, and must not exceed these dimensions within 18 mm behind its front plane (this allows for the recesses on many European socket types). The left and right side of the plug are formed by surfaces that are at 45° relative to the horizontal plan.

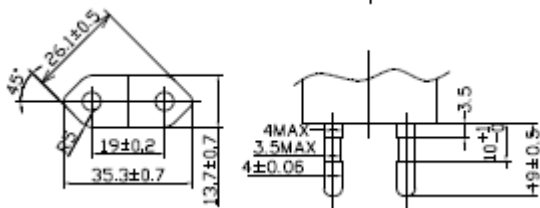

GlobTek, Inc. www.globtek.com 186 Veterans Drive, Northvale, NJ 07647 Tel. (201) 784-1000 Fax (201) 784-0111	Drawing Title: GT-86060-0505-W2E, ICT/ITE Power Supply, Efficiency Level: USA DOE Level VI / Eco-design Directive 2009/125/EC, (EU) 2019/1782, Case Color/Style: GlobTek Black, Wall Plug-in, Regulated Switchmode AC-DC Power Supply AC Adaptor, Input Rating: 100-240V~, 50/60Hz, Euro Plug Fixed , Output Rating: 5W, 5.0V@1.0A, Output Configuration: 1500 mm, 22/2 Cond, UL 2468, Female Barrel 5.5*2.1*11mm w/ Spring Clip & Locking Notch or Equal, Ferrite: None, GlobTek Black, GT Cord # C16707, Pin Out: Center Positive (+V), symbol compliant with IEC 60417 symbol no. 5926, Blades/Input Cord: Fixed Blades European CEE 7/16 2 Conductor, Approvals: EAC; Morocco; WEEE; Double Insulation; CB 62368; CE; RoHS; China RoHS; LPS 60950; Ukraine; CB 60950;	
	Model No. GT-86060-0505-W2E	
	Part No./Ordering No. WR9MA1200CCP-F(R6B)	Rev D

OUTPUT CORD AND CONNECTOR: CL1/C16707

ACTUAL CONNECTORS, OVERMOLDS, FERRITES MAY VARY SLIGHTLY FROM THE PICTURE BELOW

CABLE TYPE	UL 2468
CABLE LENGTH (mm)	1500
CABLE TOLERANCE (mm)	± 50
WIRE GAUGE (AWG)	22
CONDUCTORS	2
HANK DIMENSION (mm)	70 +/- 10
CABLE / CONNECTOR OVERMOLD COLOR	GlobTek Black
FERRITE TYPE AND DIMENSION	None
FERRITE NUMBER OF TURNS (Definition)	N/A
FERRITE DIMENSION FROM STRAIN RELIEF	N/A
FERRITE DIMENSION FROM PLUG	N/A
PLUG TYPE	Female Barrel 5.5*2.1*11mm w/ Spring Clip & Locking Notch or Equal
OUTPUT CONNECTOR GENDER	Female
OVERMOLDED	Yes
OVER MOLD ORIENTATION	Straight
CONNECTOR PIN OUT	Center Positive (+V), symbol compliant with IEC 60417 symbol no. 5926

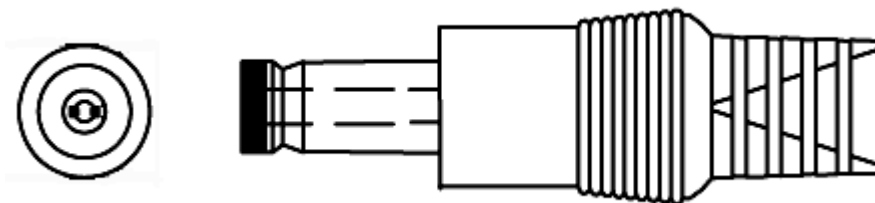

ADDITIONAL OUTPUT PLUG OPTIONS ARE AVAILABLE AT <https://www.globtek.com/connectors/>
STANDARD PLUGS AND CONNECTORS CAN BE SEEN ONLINE AT <https://www.globtek.com/connectors/>
CALCULATE VOLTAGE REGULATION/DROP WITH OUR ONLINE CALCULATOR: <https://en.globtek.com/output-cable-regulation-calculator/>

<p>GlobTek, Inc. www.globtek.com 186 Veterans Drive, Northvale, NJ 07647 Tel. (201) 784-1000 Fax (201) 784-0111</p>	<p>Drawing Title: GT-86060-0505-W2E, ICT/ITE Power Supply, Efficiency Level: USA DOE Level VI / Eco-design Directive 2009/125/EC, (EU) 2019/1782, Case Color/Style: GlobTek Black, Wall Plug-in, Regulated Switchmode AC-DC Power Supply AC Adaptor, Input Rating: 100-240V~, 50/60Hz, Euro Plug Fixed , Output Rating: 5W, 5.0V@1.0A, Output Configuration: 1500 mm, 22/2 Cond, UL 2468, Female Barrel 5.5*2.1*11mm w/ Spring Clip & Locking Notch or Equal, Ferrite: None, GlobTek Black, GT Cord # C16707, Pin Out: Center Positive (+V), symbol compliant with IEC 60417 symbol no. 5926, Blades/Input Cord: Fixed Blades European CEE 7/16 2 Conductor, Approvals: EAC; Morocco; WEEE; Double Insulation; CB 62368; CE; RoHS; China RoHS; LPS 60950; Ukraine; CB 60950;</p>
	<p>Model No. GT-86060-0505-W2E</p>
	<p>Part No./Ordering No. WR9MA1200CCP-F(R6B) Rev D</p>

OUTPUT CONNECTOR HOOK UP

TO ADDRESS SYSTEM-LEVEL EMI CONCERNS, FERRITE CHOKES/BEADS MAY BE ADDED/REVISED UPON REQUEST. A SAMPLE KIT OF GLOBTEK'S STANDARD FERRITES IS AVAILABLE UNDER GLOBTEK P/N: EMI-MITIGATION-KIT1

FOR ADDITIONAL INFORMATION, PLEASE READ OUR WHITE PAPER AT:

<https://en.globtek.com/technical-articles/ferrite-kit-radiated-emi-suppression-kit-for-globtek-power-supplies-cable-assemblies>

GloTek, Inc. www.globtek.com 186 Veterans Drive, Northvale, NJ 07647 Tel. (201) 784-1000 Fax (201) 784-0111	Drawing Title: GT-86060-0505-W2E, ICT/ITE Power Supply, Efficiency Level: USA DOE Level VI / Eco-design Directive 2009/125/EC, (EU) 2019/1782, Case Color/Style: GlobTek Black, Wall Plug-in, Regulated Switchmode AC-DC Power Supply AC Adaptor, Input Rating: 100-240V~, 50/60Hz, Euro Plug Fixed , Output Rating: 5W, 5.0V@1.0A, Output Configuration: 1500 mm, 22/2 Cond, UL 2468, Female Barrel 5.5*2.1*11mm w/ Spring Clip & Locking Notch or Equal, Ferrite: None, GlobTek Black, GT Cord # C16707, Pin Out: Center Positive (+V), symbol compliant with IEC 60417 symbol no. 5926, Blades/Input Cord: Fixed Blades European CEE 7/16 2 Conductor, Approvals: EAC; Morocco; WEEE; Double Insulation; CB 62368; CE; RoHS; China RoHS; LPS 60950; Ukraine; CB 60950;	
	Model No. GT-86060-0505-W2E	
	Part No./Ordering No. WR9MA1200CCP-F(R6B)	Rev D

LABEL:L-1186

LABEL P/N	Standard GT
MATERIAL	Flat Thermal Transfer, Imprintable, Polyester Label and/or Pad Printed and/or Molded, and/or Laser Engraved in the case
BACKGROUND COLOR	Black if housing is Black, White or Silver if housing is White or Gray.
TEXT COLOR	White or Silver if label is Black Background for Black housing. Black if label is White or Silver background and Housing is White or Gray.
LABEL WIDTH (mm)	16
LABEL HEIGHT (mm)	24
SPECIAL BARCODE LABEL MATERIAL	No

Below is the minimum information which will appear on the label. NOTE: in the logo area additional/actual positioning of symbols and text is subjected to change as per agency updates/requirements or additional model approvals become available. Regulatory certifications/label markings may be in logo area on the label or molded into the case housing outside the label area. Information will be shown via label and/or pad printed and/or molded and/or laser engraved in the case. * Date code markings at GlobTek option

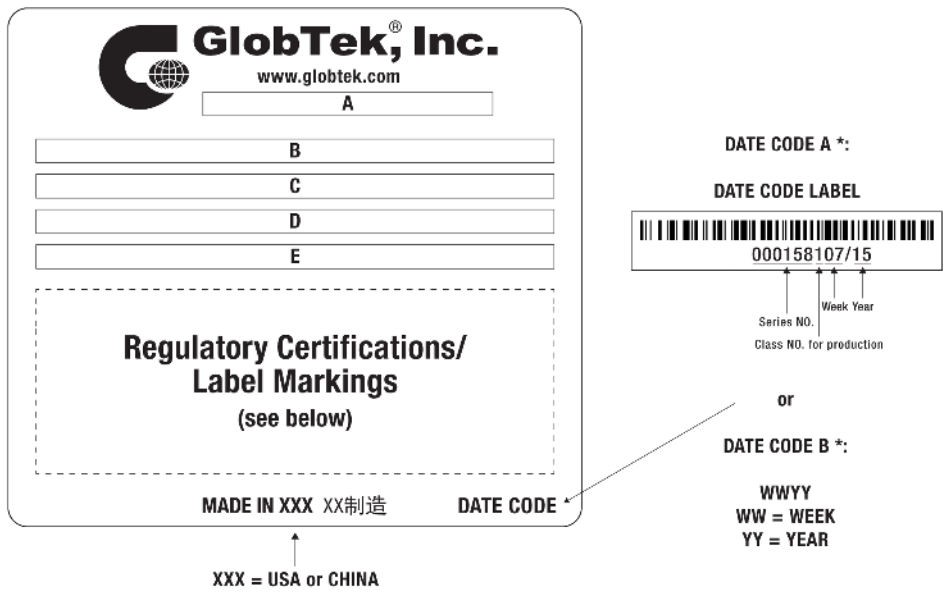

A=ICT/ITE Power Supply
B=P/N: (料号) WR9MA1200CCP-F(R6B)
C=Model (型号) GT-86060-0505-W2E
D=Input (输入)100-240V~, 50/60Hz, 0.2A
E=Output (输出)5.0 V 1.0 A, 5.00W

GloTek, Inc. www.globtek.com 186 Veterans Drive, Northvale, NJ 07647 Tel. (201) 784-1000 Fax (201) 784-0111	Drawing Title: GT-86060-0505-W2E, ICT/ITE Power Supply, Efficiency Level: USA DOE Level VI / Eco-design Directive 2009/125/EC, (EU) 2019/1782, Case Color/Style: GlobTek Black, Wall Plug-in, Regulated Switchmode AC-DC Power Supply AC Adaptor, Input Rating: 100-240V~, 50/60Hz, Euro Plug Fixed , Output Rating: 5W, 5.0V@1.0A, Output Configuration: 1500 mm, 22/2 Cond, UL 2468, Female Barrel 5.5*2.1*11mm w/ Spring Clip & Locking Notch or Equal, Ferrite: None, GlobTek Black, GT Cord # C16707, Pin Out: Center Positive (+V), symbol compliant with IEC 60417 symbol no. 5926, Blades/Input Cord: Fixed Blades European CEE 7/16 2 Conductor, Approvals: EAC; Morocco; WEEE; Double Insulation; CB 62368; CE; RoHS; China RoHS; LPS 60950; Ukraine; CB 60950;	
	Model No. GT-86060-0505-W2E	
	Part No./Ordering No. WR9MA1200CCP-F(R6B)	Rev D

AGENCY ONLINE DOCUMENTS	http://www.globtek.info/certs/GT-86060-WVVV-W2Z/
CE EC-Declaration for Medical	Contact GlobTek for more information
CE EC-Declaration for Industrial/Commercial/ITE	http://globtek.force.com/models/ec_declaration_product?id=01ta0000005yAvJ&i=2
CE EC-Declaration for Household	Contact GlobTek for more information
UKCA-Declaration for Medical	Contact GlobTek for more information
UKCA-Declaration for Industrial/Commercial/ITE	http://globtek.force.com/models/ukca_declaration_product?id=01ta0000005yAvJ&i=2
UKCA-Declaration for Household	Contact GlobTek for more information
Morocco SDoC Declaration	https://globtek.secure.force.com/models/Morocco_SDoC_Declaration?id=a0Oa000000MmdtPEAR
RoHS/RoHS3 Declaration	https://www.globtek.com/pdf/rohs_cert/01ta0000005yAvJAAU
REACH Declaration	https://www.globtek.com/pdf/iso_certificates/REACH.pdf
Conflict Minerals Declaration	https://www.globtek.com/pdf/conflict-minerals.pdf
Prop 65 Statement	https://en.globtek.com/prop-65-statement.pdf
IPXY rating is based on 3rd party testing and customers should check suitability and test system level IPXY rating before ordering.	

Regulatory Certifications/Label Markings

Below follows a link to the latest regulatory certifications and marks for this specific product. National standards as well as certification schemes are constantly changing and so is the set of certification marks and symbols applicable to this product. Various standards, marks and symbols, and certificates are subject to change at any time without notice.

Additional standards or unique country certifications are available upon request. Please contact Globtek to request a quotation.

LATEST PRODUCT/MODEL CERTIFICATIONS: <https://www.globtek.com/datasheet/w71105>

AGENCY ONLINE DOCUMENTS <http://www.globtek.info/certs/GT-86060-WVVV-W2Z/>



(F1) Class II / Double Insulated

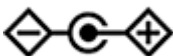

Center Positive (+V), symbol compliant with IEC 60417 symbol no. 5926

GloTek, Inc. www.globtek.com 186 Veterans Drive, Northvale, NJ 07647 Tel. (201) 784-1000 Fax (201) 784-0111	Drawing Title: GT-86060-0505-W2E, ICT/ITE Power Supply, Efficiency Level: USA DOE Level VI / Eco-design Directive 2009/125/EC, (EU) 2019/1782, Case Color/Style: GlobTek Black, Wall Plug-in, Regulated Switchmode AC-DC Power Supply AC Adaptor, Input Rating: 100-240V~, 50/60Hz, Euro Plug Fixed , Output Rating: 5W, 5.0V@1.0A, Output Configuration: 1500 mm, 22/2 Cond, UL 2468, Female Barrel 5.5*2.1*11mm w/ Spring Clip & Locking Notch or Equal, Ferrite: None, GlobTek Black, GT Cord # C16707, Pin Out: Center Positive (+V), symbol compliant with IEC 60417 symbol no. 5926, Blades/Input Cord: Fixed Blades European CEE 7/16 2 Conductor, Approvals: EAC; Morocco; WEEE; Double Insulation; CB 62368; CE; RoHS; China RoHS; LPS 60950; Ukraine; CB 60950;	
	Model No. GT-86060-0505-W2E	
	Part No./Ordering No. WR9MA1200CCP-F(R6B)	Rev D

PACKAGING

Packing Spec P/N	Standard WPI non changeable, Individually Box, User manual
Box Qty	120
Gift Box Size (mm)	75*85*51
Gift Box Color	White
Master Carton Size (mm)	445 x 326 x 335
Master Carton Cubic Volume (m³)	0.05
Master GW (Kg)	15.6 kg
BLADES INCLUDED	FBEuro2: Fixed Blades European CEE 7/16 2 Conductor
BLADE/CORD INSTALLED	FBEuro2: Fixed Blades European CEE 7/16 2 Conductor
USER MANUAL*	809-DESKTOPUSERMANUAL on A4 paper
USER MANUAL WEB LINK	https://en.globtek.com/pdf/809-DESKTOPUSERMANUAL.jpg

* This specification sheet is considered the user manual for all applications. It is expected that the buyer of this product will use it to formulate their own user manual for their end product and a user manual specifically for the power adapter is not usually required. If a user manual is not specifically listed above then none will be provided with this unit.

If specific packaging is required, this section must specify all requirements and note "no exceptions". If this section does not specify packaging, it is subject to change without notice at GlobTek's discretion

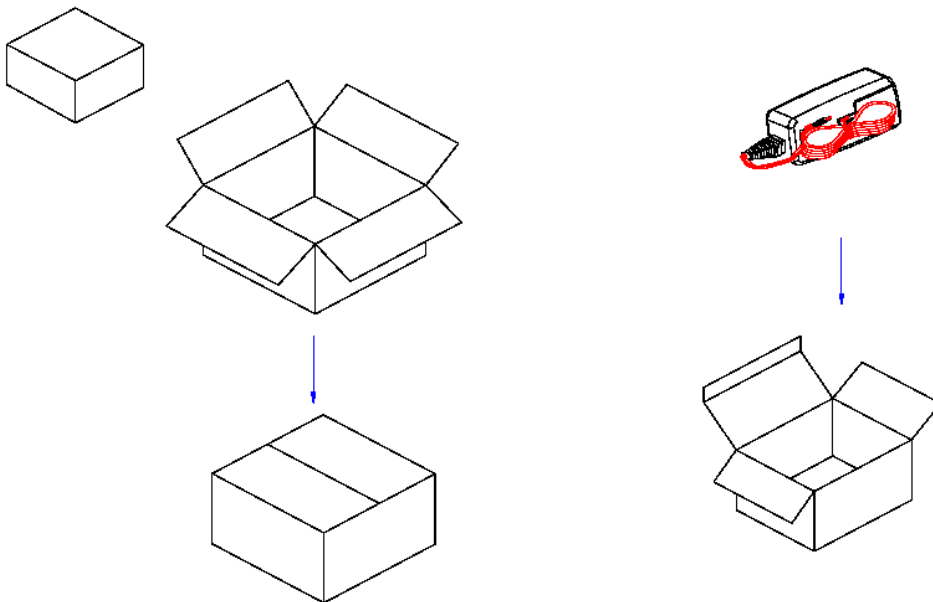

PROPRIETARY INFORMATION

<p>GlobTek, Inc. www.globtek.com 186 Veterans Drive, Northvale, NJ 07647 Tel. (201) 784-1000 Fax (201) 784-0111</p>	<p>Drawing Title: GT-86060-0505-W2E, ICT/ITE Power Supply, Efficiency Level: USA DOE Level VI / Eco-design Directive 2009/125/EC, (EU) 2019/1782, Case Color/Style: GlobTek Black, Wall Plug-in, Regulated Switchmode AC-DC Power Supply AC Adaptor, Input Rating: 100-240V~, 50/60Hz, Euro Plug Fixed , Output Rating: 5W, 5.0V@1.0A, Output Configuration: 1500 mm, 22/2 Cond, UL 2468, Female Barrel 5.5*2.1*11mm w/ Spring Clip & Locking Notch or Equal, Ferrite: None, GlobTek Black, GT Cord # C16707, Pin Out: Center Positive (+V), symbol compliant with IEC 60417 symbol no. 5926, Blades/Input Cord: Fixed Blades European CEE 7/16 2 Conductor, Approvals: EAC; Morocco; WEEE; Double Insulation; CB 62368; CE; RoHS; China RoHS; LPS 60950; Ukraine; CB 60950;</p>
	<p>Model No. GT-86060-0505-W2E</p>
	<p>Part No./Ordering No. WR9MA1200CCP-F(R6B) Rev D</p>

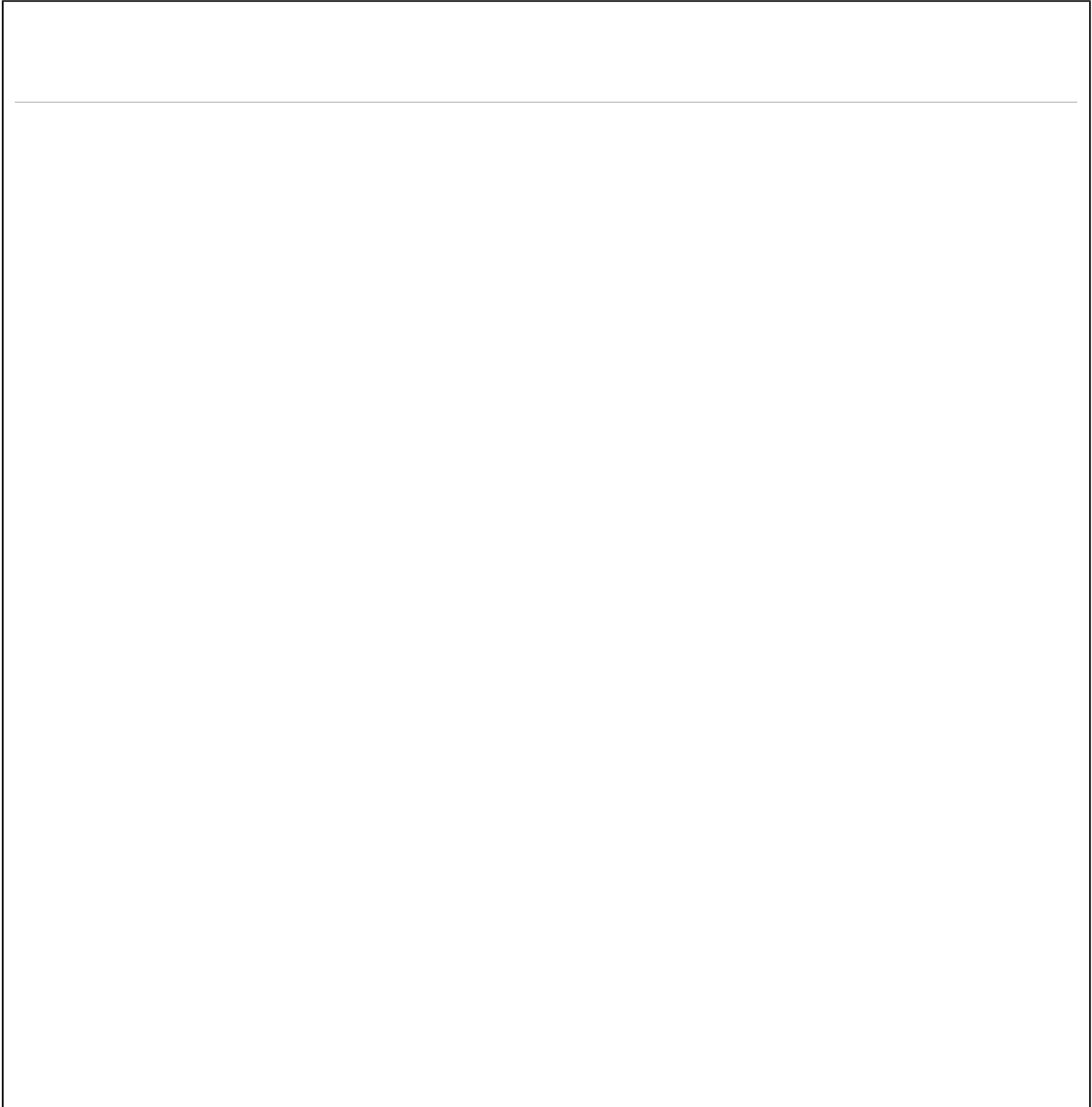

<p>GlobTek, Inc. www.globtek.com 186 Veterans Drive, Northvale, NJ 07647 Tel. (201) 784-1000 Fax (201) 784-0111</p>	<p>Drawing Title: GT-86060-0505-W2E, ICT/ITE Power Supply, Efficiency Level: USA DOE Level VI / Eco-design Directive 2009/125/EC, (EU) 2019/1782, Case Color/Style: GlobTek Black, Wall Plug-in, Regulated Switchmode AC-DC Power Supply AC Adaptor, Input Rating: 100-240V~, 50/60Hz, Euro Plug Fixed , Output Rating: 5W, 5.0V@1.0A, Output Configuration: 1500 mm, 22/2 Cond, UL 2468, Female Barrel 5.5*2.1*11mm w/ Spring Clip & Locking Notch or Equal, Ferrite: None, GlobTek Black, GT Cord # C16707, Pin Out: Center Positive (+V), symbol compliant with IEC 60417 symbol no. 5926, Blades/Input Cord: Fixed Blades European CEE 7/16 2 Conductor, Approvals: EAC; Morocco; WEEE; Double Insulation; CB 62368; CE; RoHS; China RoHS; LPS 60950; Ukraine; CB 60950;</p>
	<p>Model No. GT-86060-0505-W2E</p>
	<p>Part No./Ordering No. WR9MA1200CCP-F(R6B) Rev D</p>

INSTRUCTIONS TO THE OEM SYSTEMS ENGINEER

It is the responsibility of the OEM systems engineer to provide the end system user instructions and warnings for the use of this product in the end system.

If an input cord is required for this product, AC Mains voltage should be provided to the power supply by a power supply cord approved to the national standards of the country in which it will be used.

This product is not designed to be repaired. No serviceable parts inside. A blown internal fuse is an indication of catastrophic failure of circuit component(s). If a Failure Analysis is required for a failed power supply/battery charger, please return the damaged unit to GlobTek for an accurate determination of the root cause of the failure.

EMC Compliance of the complete OEM product, including the GlobTek power supply/battery charger needs to be verified by the OEM systems engineer.

INSTRUCTION SHEET

N/A

<p>GlobTek, Inc. www.globtek.com 186 Veterans Drive, Northvale, NJ 07647 Tel. (201) 784-1000 Fax (201) 784-0111</p>	<p>Drawing Title: GT-86060-0505-W2E, ICT/ITE Power Supply, Efficiency Level: USA DOE Level VI / Eco-design Directive 2009/125/EC, (EU) 2019/1782, Case Color/Style: GlobTek Black, Wall Plug-in, Regulated Switchmode AC-DC Power Supply AC Adaptor, Input Rating: 100-240V~, 50/60Hz, Euro Plug Fixed , Output Rating: 5W, 5.0V@1.0A, Output Configuration: 1500 mm, 22/2 Cond, UL 2468, Female Barrel 5.5*2.1*11mm w/ Spring Clip & Locking Notch or Equal, Ferrite: None, GlobTek Black, GT Cord # C16707, Pin Out: Center Positive (+V), symbol compliant with IEC 60417 symbol no. 5926, Blades/Input Cord: Fixed Blades European CEE 7/16 2 Conductor, Approvals: EAC; Morocco; WEEE; Double Insulation; CB 62368; CE; RoHS; China RoHS; LPS 60950; Ukraine; CB 60950;</p>
	<p>Model No. GT-86060-0505-W2E</p>
	<p>Part No./Ordering No. WR9MA1200CCP-F(R6B) Rev D</p>

