

## Photomicrosensor (Transmissive) EE-SX1131

 Be sure to read *Precautions* on page 25.

### ■ Dimensions

**Note:** All units are in millimeters unless otherwise indicated.

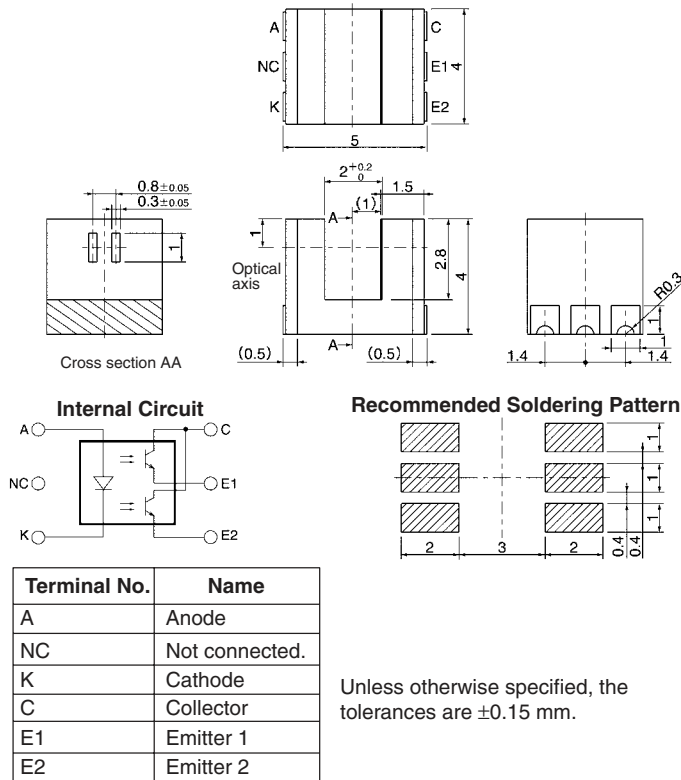

### ■ Features

- Ultra-compact with a 5-mm-wide sensor and a 2-mm-wide slot.
- PCB surface mounting type.
- High resolution with a 0.3-mm-wide aperture.
- Dual-channel output.

### ■ Absolute Maximum Ratings (Ta = 25°C)

Item	Symbol	Rated value
Emitter	Forward current	$I_F$ 25 mA (see note 1)
	Pulse forward current	$I_{FP}$ 100 mA (see note 2)
	Reverse voltage	$V_R$ 5 V
Detector	Collector–Emitter voltage	$V_{CEO}$ 20 V
	Emitter–Collector voltage	$V_{ECO}$ 5 V
	Collector current	$I_C$ 20 mA
	Collector dissipation	$P_C$ 75 mW (see note 1)
Ambient temperature	Operating	$T_{opr}$ -30°C to 85°C
	Storage	$T_{stg}$ -40°C to 90°C
	Reflow soldering	$T_{sol}$ 255°C (see note 3)
	Manual soldering	$T_{sol}$ 350°C (see note 3)

- Note:**
1. Refer to the temperature rating chart if the ambient temperature exceeds 25°C.
  2. Duty: 1/100; Pulse width: 0.1 ms
  3. Complete soldering within 10 seconds for reflow soldering and within 3 seconds for manual soldering.

### ■ Electrical and Optical Characteristics (Ta = 25°C)

Item	Symbol	Value	Condition
Emitter	Forward voltage	$V_F$ 1.1 V typ., 1.3 V max.	$I_F = 5$ mA
	Reverse current	$I_R$ 10 $\mu$ A max.	$V_R = 5$ V
	Peak emission wavelength	$\lambda_P$ 940 nm typ.	$I_F = 20$ mA
Detector	Light current	$I_{L1}/I_{L2}$ 50 $\mu$ A min., 150 $\mu$ A typ., 500 $\mu$ A max.	$I_F = 5$ mA, $V_{CE} = 5$ V
	Dark current	$I_D$ 100 nA max.	$V_{CE} = 10$ V, 0 lx
	Leakage current	$I_{LEAK}$ ---	---
	Collector–Emitter saturated voltage	$V_{CE}(\text{sat})$ 0.1 V typ., 0.4 V max.	$I_F = 20$ mA, $I_L = 50$ $\mu$ A
	Peak spectral sensitivity wavelength	$\lambda_P$ 900 nm typ.	---
Rising time	$t_r$ 10 $\mu$ s typ.	$V_{CC} = 5$ V, $R_L = 1$ k $\Omega$ , $I_L = 100$ $\mu$ A	
Falling time	$t_f$ 10 $\mu$ s typ.	$V_{CC} = 5$ V, $R_L = 1$ k $\Omega$ , $I_L = 100$ $\mu$ A	

Engineering Data

Forward Current vs. Collector Dissipation Temperature Rating

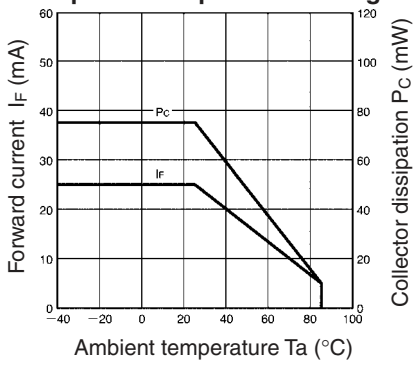

Forward Current vs. Forward Voltage Characteristics (Typical)

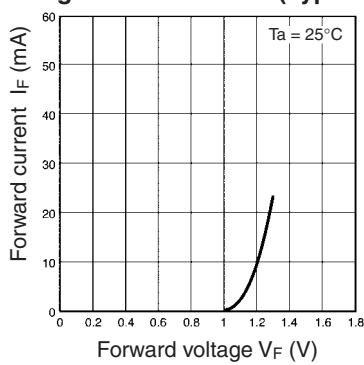

Light Current vs. Forward Current Characteristics (Typical)

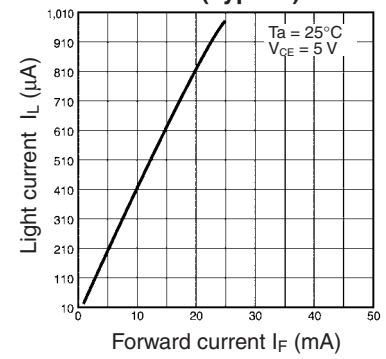

Light Current vs. Collector-Emitter Voltage Characteristics (Typical)

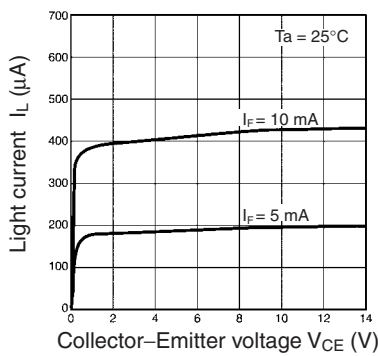

Relative Light Current vs. Ambient Temperature Characteristics (Typical)

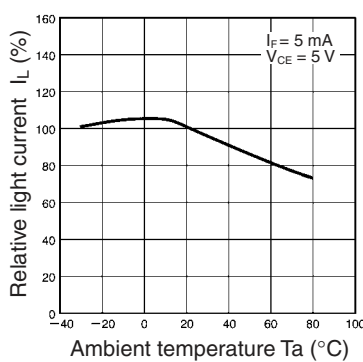

Dark Current vs. Ambient Temperature Characteristics (Typical)

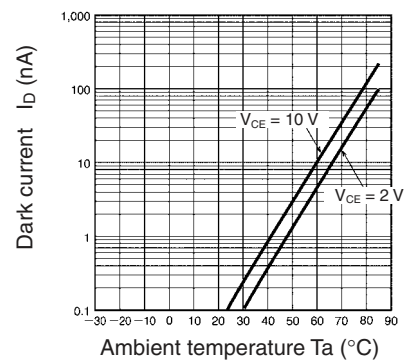

Response Time vs. Load Resistance Characteristics (Typical)

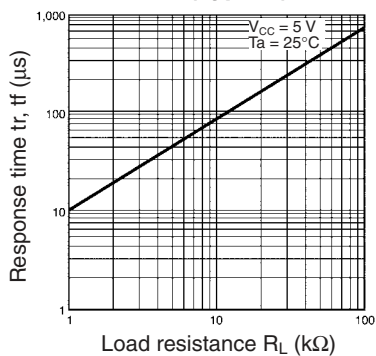

Sensing Position Characteristics (Typical)

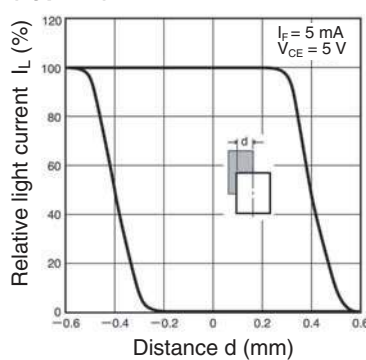

Sensing Position Characteristics (Typical)

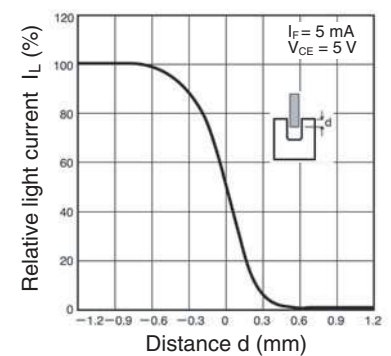

Response Time Measurement Circuit

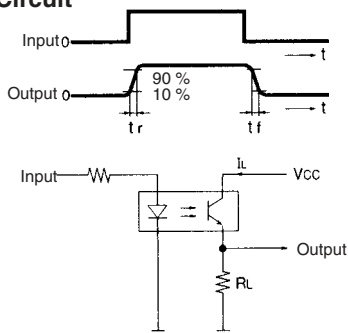

Unit: mm (inch)

■ Tape and Reel

Reel

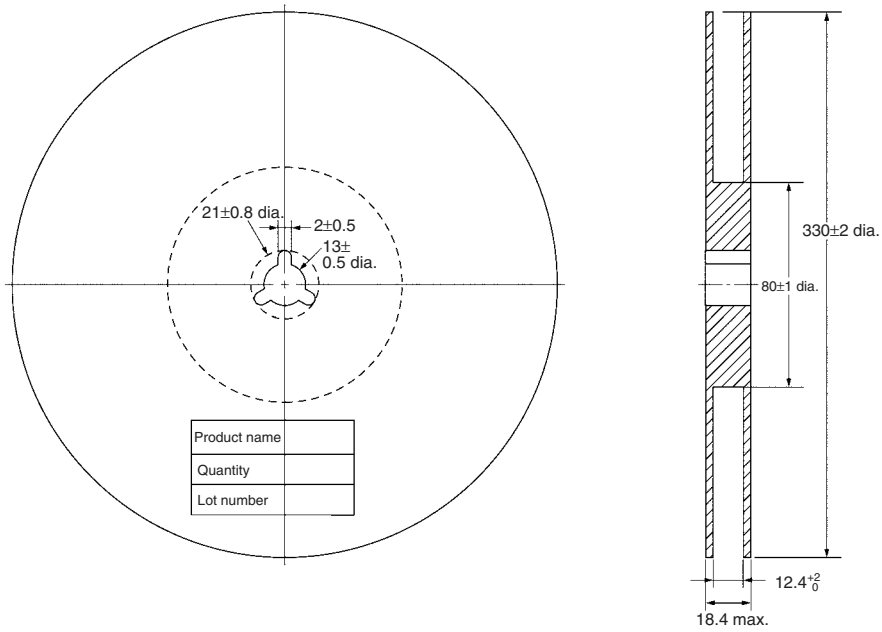

Tape

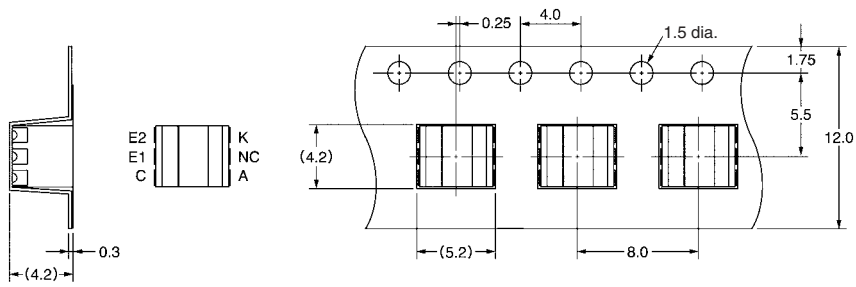

Tape configuration

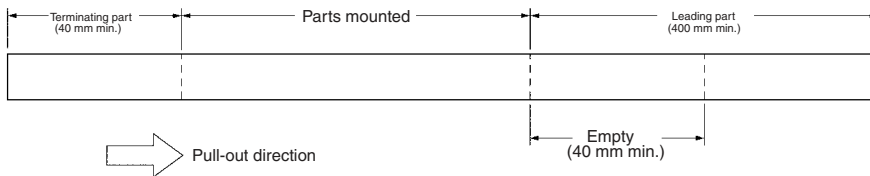

Tape quantity

2,000 pcs./reel

# Precautions

## ■ Soldering Information

### Reflow soldering

- The following soldering paste is recommended:  
Melting temperature: 216 to 220°C  
Composition: Sn 3.5 Ag 0.75 Cu
- The recommended thickness of the metal mask for screen printing is between 0.2 and 0.25 mm.
- Set the reflow oven so that the temperature profile shown in the following chart is obtained for the upper surface of the product being soldered.

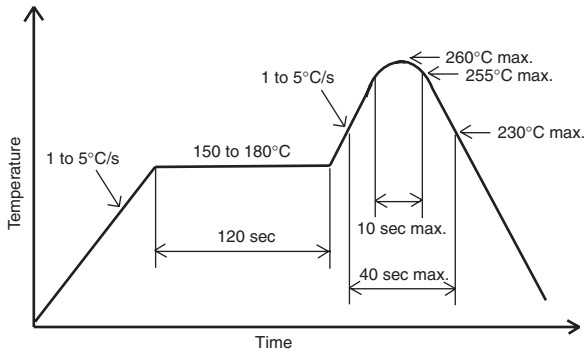

### Manual soldering

- Use "Sn 60" (60% tin and 40% lead) or solder with silver content.
- Use a soldering iron of less than 25 W, and keep the temperature of the iron tip at 300°C or below.
- Solder each point for a maximum of three seconds.
- After soldering, allow the product to return to room temperature before handling it.

### Storage

To protect the product from the effects of humidity until the package is opened, dry-box storage is recommended. If this is not possible, store the product under the following conditions:

Temperature: 10 to 30°C

Humidity: 60% max.

The product is packed in a humidity-proof envelope. Reflow soldering must be done within 48 hours after opening the envelope, during which time the product must be stored under 30°C at 80% maximum humidity.

If it is necessary to store the product after opening the envelope, use dry-box storage or reseal the envelope.

### Baking

If a product has remained packed in a humidity-proof envelope for six months or more, or if more than 48 hours have lapsed since the envelope was opened, bake the product under the following conditions before use:

Reel: 60°C for 24 hours or more

Bulk: 80°C for 4 hours or more