

Model 416

Ultra-Miniature Surface Mount Crystal

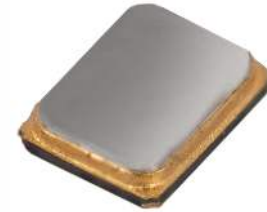

Part Dimensions:
1.6 × 1.2 × 0.45mm • 2.51054mg

Features

- Hermetic Ceramic Surface Mount Package
- Fundamental Crystal Design
- Frequency Range 24 – 80MHz
- Frequency Tolerance, ±30ppm Standard
- Frequency Stability, ±30ppm Standard
- Operating Temperature Range to -40°C to +105°C
- Tape and Reel Packaging, EIA-481

Standard Frequencies – see Page 5 for common frequencies.
* Check with factory for availability of frequencies not listed.

Applications

- IoT and IIoT Applications
- Wireless Communications
- FPGA/Microcontrollers
- USB Interfaces
- Computer Peripherals
- Portable Equipment
- Test and Measurement
- M2M Communications
- Wearables

Description

CTS Model 416 incorporates a high Q quartz resonator and is ideal for supporting a wide range of commercial and industrial applications.

Ordering Information

Model	Mode of Oscillation	Frequency Code [MHz]	Tolerance @ +25°C	Temperature Stability	Temperature Range	Load Capacitance	Packaging																																														
416	F	XXX	3	3	C	K	R																																														
<table border="1"> <thead> <tr> <th>Code</th> <th>Mode</th> </tr> </thead> <tbody> <tr> <td>F</td> <td>Fundamental</td> </tr> </tbody> </table>		Code	Mode	F	Fundamental	<table border="1"> <thead> <tr> <th>Code</th> <th>Tolerance</th> </tr> </thead> <tbody> <tr> <td>1</td> <td>±10ppm</td> </tr> <tr> <td>X</td> <td>±15ppm</td> </tr> <tr> <td>2</td> <td>±20ppm</td> </tr> <tr> <td>Y</td> <td>±25ppm</td> </tr> <tr> <td>3</td> <td>±30ppm</td> </tr> </tbody> </table>		Code	Tolerance	1	±10ppm	X	±15ppm	2	±20ppm	Y	±25ppm	3	±30ppm	<table border="1"> <thead> <tr> <th>Code</th> <th>Temp. Range</th> </tr> </thead> <tbody> <tr> <td>A</td> <td>-10°C to +60°C²</td> </tr> <tr> <td>C</td> <td>-20°C to +70°C²</td> </tr> <tr> <td>D</td> <td>-30°C to +85°C²</td> </tr> <tr> <td>I</td> <td>-40°C to +85°C³</td> </tr> <tr> <td>G</td> <td>-40°C to +105°C⁴</td> </tr> </tbody> </table>		Code	Temp. Range	A	-10°C to +60°C ²	C	-20°C to +70°C ²	D	-30°C to +85°C ²	I	-40°C to +85°C ³	G	-40°C to +105°C ⁴	<table border="1"> <thead> <tr> <th>Code</th> <th>Packing</th> </tr> </thead> <tbody> <tr> <td>R</td> <td>3k pcs./reel</td> </tr> </tbody> </table>		Code	Packing	R	3k pcs./reel														
Code	Mode																																																				
F	Fundamental																																																				
Code	Tolerance																																																				
1	±10ppm																																																				
X	±15ppm																																																				
2	±20ppm																																																				
Y	±25ppm																																																				
3	±30ppm																																																				
Code	Temp. Range																																																				
A	-10°C to +60°C ²																																																				
C	-20°C to +70°C ²																																																				
D	-30°C to +85°C ²																																																				
I	-40°C to +85°C ³																																																				
G	-40°C to +105°C ⁴																																																				
Code	Packing																																																				
R	3k pcs./reel																																																				
<table border="1"> <thead> <tr> <th>Code</th> <th>Frequency</th> </tr> </thead> <tbody> <tr> <td colspan="2">Product Frequency Code¹</td> </tr> </tbody> </table>		Code	Frequency	Product Frequency Code ¹		<table border="1"> <thead> <tr> <th>Code</th> <th>Stability</th> <th>Code</th> <th>Stability</th> </tr> </thead> <tbody> <tr> <td>1</td> <td>±10ppm</td> <td>Y</td> <td>±25ppm</td> </tr> <tr> <td>X</td> <td>±15ppm</td> <td>3</td> <td>±30ppm</td> </tr> <tr> <td>2</td> <td>±20ppm</td> <td>5</td> <td>±50ppm</td> </tr> </tbody> </table>		Code	Stability	Code	Stability	1	±10ppm	Y	±25ppm	X	±15ppm	3	±30ppm	2	±20ppm	5	±50ppm	<table border="1"> <thead> <tr> <th>Code</th> <th>Capacitance</th> <th>Code</th> <th>Capacitance</th> </tr> </thead> <tbody> <tr> <td>W</td> <td>5pF</td> <td>L</td> <td>12pF</td> </tr> <tr> <td>T</td> <td>6pF</td> <td>B</td> <td>13pF</td> </tr> <tr> <td>V</td> <td>7pF</td> <td>C</td> <td>16pF</td> </tr> <tr> <td>K</td> <td>8pF</td> <td>D</td> <td>18pF</td> </tr> <tr> <td>J</td> <td>9pF</td> <td>E</td> <td>20pF</td> </tr> <tr> <td>A</td> <td>10pF</td> <td>S</td> <td>Series</td> </tr> </tbody> </table>		Code	Capacitance	Code	Capacitance	W	5pF	L	12pF	T	6pF	B	13pF	V	7pF	C	16pF	K	8pF	D	18pF	J	9pF	E	20pF	A	10pF	S	Series
Code	Frequency																																																				
Product Frequency Code ¹																																																					
Code	Stability	Code	Stability																																																		
1	±10ppm	Y	±25ppm																																																		
X	±15ppm	3	±30ppm																																																		
2	±20ppm	5	±50ppm																																																		
Code	Capacitance	Code	Capacitance																																																		
W	5pF	L	12pF																																																		
T	6pF	B	13pF																																																		
V	7pF	C	16pF																																																		
K	8pF	D	18pF																																																		
J	9pF	E	20pF																																																		
A	10pF	S	Series																																																		

Notes:

- 1] Refer to document 016-1454-0, Frequency Code Tables. 3-digits for frequencies <100MHz.
- 2] Available with all stability codes.
- 3] Available with stability codes X, 2, Y, 3 and 5.
- 4] Available with stability codes 3 and 5.

**Not all performance combinations and frequencies may be available.
Contact your local CTS Representative or CTS Customer Service for availability.**

This product is specified for use only in standard commercial applications. Supplier disclaims all express and implied warranties and liability in connection with any use of this product in any non-commercial applications or in any application that may expose the product to conditions that are outside of the tolerances provided in its specification.



Electrical Specifications

Operating Conditions

PARAMETER	SYMBOL	CONDITIONS	MIN	TYP	MAX	UNIT
Operating Temperature	T _A	-	-10		+60	°C
			-20		+70	
			-30	+25	+85	
			-40		+85	
			-40		+105	
Storage Temperature	T _{STG}	-	-40	-	+125	°C

Frequency Stability

PARAMETER	SYMBOL	CONDITIONS	MIN	TYP	MAX	UNIT
Frequency Range	f ₀	-		24 - 80		MHz
Frequency Tolerance	Δf/f ₀	@ +25°C		10, 15, 20, 25 or 30		±ppm
Frequency Stability	Δf/f ₂₅	Referenced to +25°C reading		10, 15, 20, 25, 30 or 50		±ppm
Aging	Δf/f ₀	Typical per year @ +25°C	-3	-	3	ppm

Crystal Parameters

PARAMETER	SYMBOL	CONDITIONS	MIN	TYP	MAX	UNIT
Operating Mode	-	-		Fundamental		-
Crystal Cut	-	-		AT-Cut Strip		-
Load Capacitance	C _L	-		See Ordering Information		pF
Shunt Capacitance	C ₀	-	-	-	3.0	pF
Series Resistance						
Fundamental	R ₁	24MHz - <40MHz	-	-	150	Ω
		40MHz - <54MHz	-	-	100	
		54MHz - 80MHz	-	-	60	
Drive Level	DL	-	-	10	120	μW
Insulation Resistance	R _i	+100Vdc ±15Vdc	500	-	-	MΩ

Δf/f₀ - Frequency deviation referenced to nominal frequency.

Δf/f₂₅ - Frequency deviation over operating temperature range, referenced to +25°C frequency.

Mechanical Specifications

Package Drawing

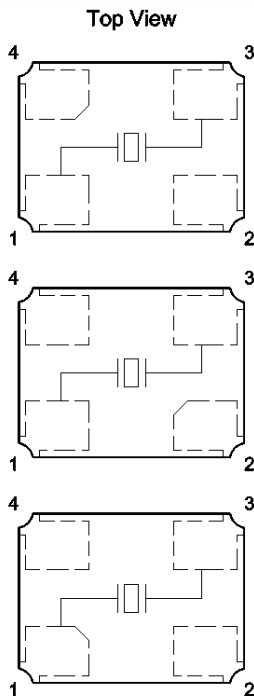
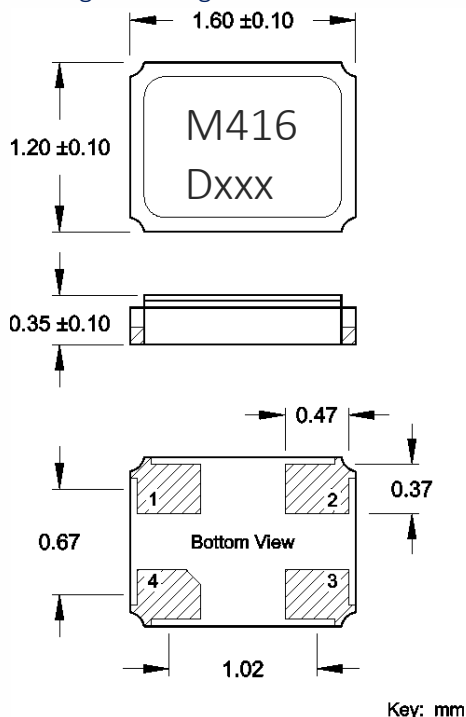

Marking Information

Format A – 2 Lines [Preferred]

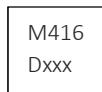

1. M416 – CTS Model series.
2. D – Date code. See Table I for codes.
3. xxx – Frequency code, 3-digits frequencies below 100MHz. [See document 016-1454-0, Frequency Code Tables].

Format B – 1 Line [Acceptable]

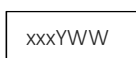

1. xxx – Frequency code, 3-digits frequencies below 100MHz. [See document 016-1454-0, Frequency Code Tables].
2. YWW – Date code; Y = year [last digit], WW = week.

Recommended Pad Layout

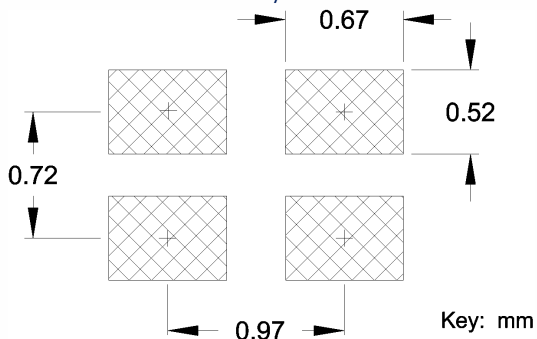

Notes

1. JEDEC termination code (e4). Barrier-plating is nickel [Ni] with gold [Au] flash plate.
2. Terminations #2, #4 and the metal lid are connected internally. End user may connect these pins to circuit ground for EMI suppression.
3. Due to package variability, the pad chamfer on the bottom could be located on Pin 1, 2 or 4 in a given lot. Layout orientation should be based on the top view [marking side], as indicated in package drawing. The chamfer location does not affect the electrical performance of the device.
4. Reflow conditions per JEDEC J-STD-020; +260°C maximum, 20 seconds.
5. MSL = 1.

Table I – Date Code, Beginning year 2021

MONTH					YEAR											
					JAN	FEB	MAR	APR	MAY	JUN	JUL	AUG	SEP	OCT	NOV	DEC
2021	2025	2029	2033	2037	A	B	C	D	E	F	G	H	J	K	L	M
2022	2026	2030	2034	2038	N	P	Q	R	S	T	U	V	W	X	Y	Z
2023	2027	2031	2035	2039	a	b	c	d	e	f	g	h	j	k	l	m
2024	2028	2032	2036	2040	n	p	q	r	s	t	u	v	w	x	y	z

Packaging – Tape and Reel

Tape Drawing

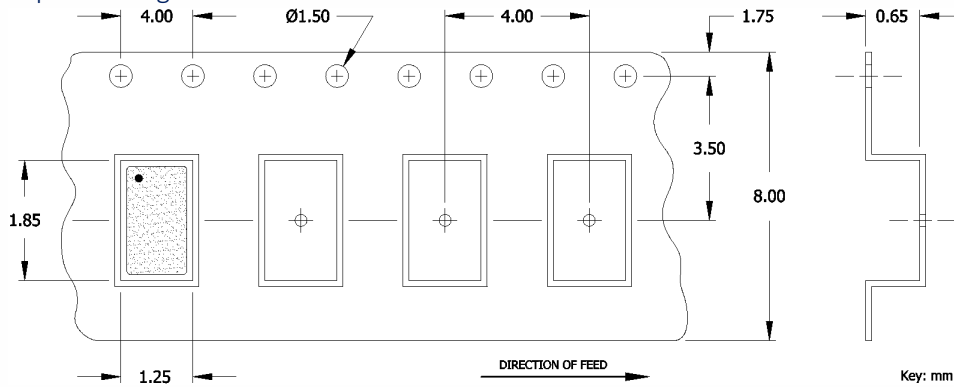

Reel Drawing

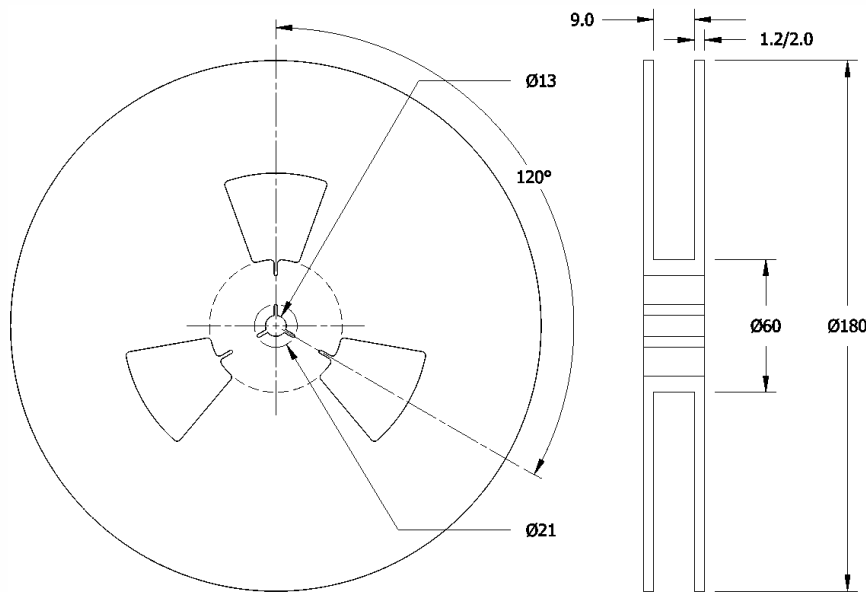

Notes

1. Device quantity is 1k pieces minimum and 3k pieces maximum per 180mm reel.
2. Complete CTS part number, frequency value, date code and manufacturing site code information must appear on reel and carton labels.



Addendum

Common Frequencies and Frequency Codes – MHz

Common Wireless Frequencies		Other Frequencies					
FREQUENCY	FREQUENCY CODE	FREQUENCY	FREQUENCY CODE	FREQUENCY	FREQUENCY CODE	FREQUENCY	FREQUENCY CODE
32.000000	320	32.768000	327				
37.400000	374	33.000000	330				
38.400000	384	33.330000	333				
40.000000	400	33.333000	33E				
48.000000	480	33.333300	33A				
52.000000	520	33.868800	338				
		35.328000	353				
		36.000000	360				
		38.000000	380				
		38.880000	388				
		39.062500	39A				
		41.600000	41C				
		44.000000	440				
		45.000000	450				
		49.152000	491				
		50.000000	500				
		54.000000	540				