

THIS DRAWING IS UNPUBLISHED.

RELEASED FOR PUBLICATION

© COPYRIGHT - BY TYCO ELECTRONICS CORPORATION. ALL INTERNATIONAL RIGHTS RESERVED.

LOC		DIST		REVISIONS			
P	LTR	DESCRIPTION		DATE	DWN	APVD	
	A1	ECR-17-009675		04JUL17	MG	BM	

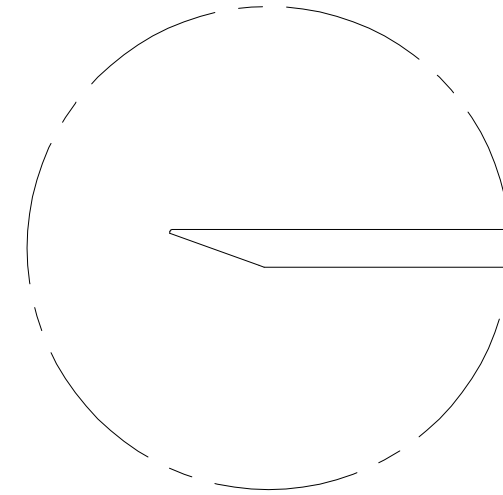
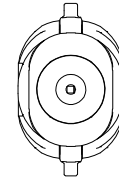
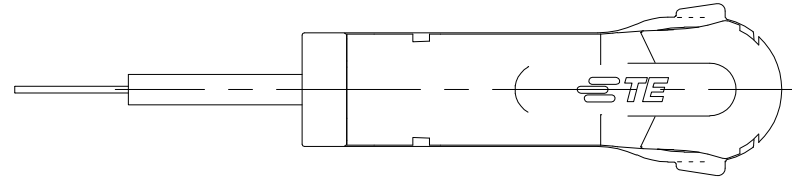

B

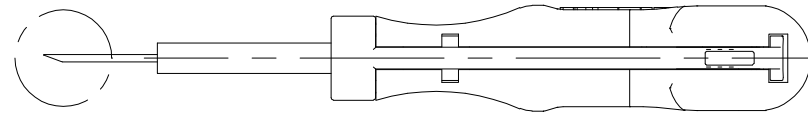

B

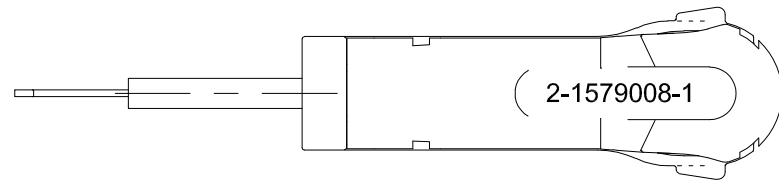
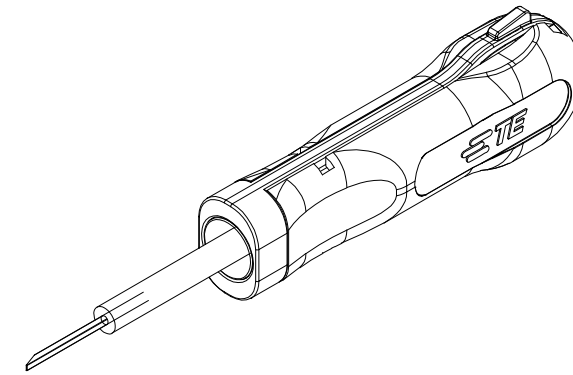

2-1579008-1

THIS DRAWING IS A CONTROLLED DOCUMENT.

DWN 06.11.2006

m.pearson

CHK



DIMENSIONS:

mm

TOLERANCES UNLESS OTHERWISE SPECIFIED:

- 0 PLC ± -
- 1 PLC ± -
- 2 PLC ± -
- 3 PLC ± -
- 4 PLC ± -
- ANGLES ± -

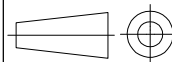

MATERIAL

FINISH

APVD

PRODUCT SPEC

APPLICATION SPEC

WEIGHT

0.016 kg

NAME

EXTRACTION TOOL
Entriegelungswerkzeug

SIZE

CAGE CODE

DRAWING NO

RESTRICTED TO

A3

00779

C-2-1579008-1

CUSTOMER DRAWING

SCALE 1:1

SHEET 1 OF 1

REV A1