

1747066-4 ✓ ACTIVE



GRACE INERTIA 2.5

TE Internal #: 1747066-4

Housing, Plug, Wire-to-Board, 4 Position, .098 in [2.5 mm]

Centerline, Crimp, 1 Row, Natural, Mating Retention, Wire & Cable,

GRACE INERTIA 2.5

[View on TE.com >](#)

Connectors > PCB Connectors > Wire-to-Board Connectors > Wire-to-Board Connector Assemblies & Housings

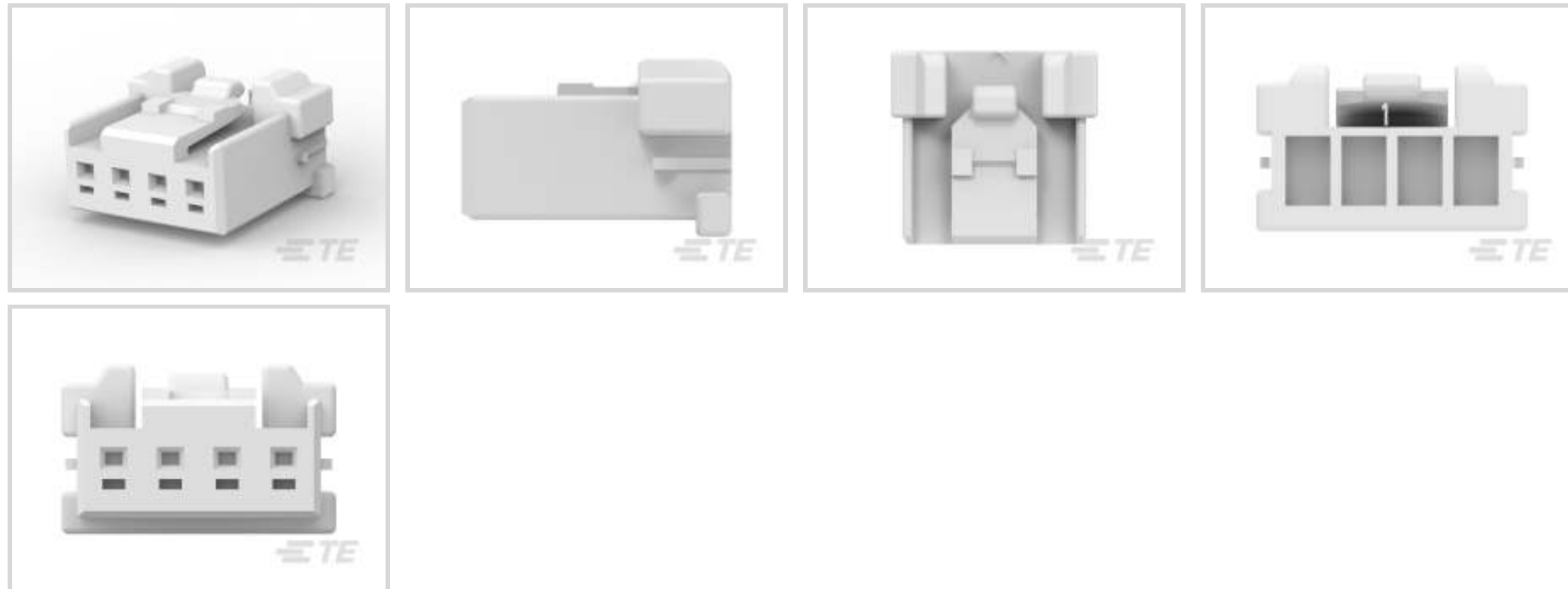

Connector Product Type: **Housing**

Connector & Housing Type: **Plug**

Connector System: **Wire-to-Board**

Number of Positions: **4**

Centerline (Pitch): **2.5 mm [.098 in]**

Features

Product Type Features

Connector Product Type	Housing
Connector & Housing Type	Plug
Connector System	Wire-to-Board
Sealable	No
Connector & Contact Terminates To	Wire & Cable

Configuration Features

Number of Positions	4
Number of Rows	1

Electrical Characteristics

Operating Voltage	50 VAC
-------------------	--------

Body Features

Primary Product Color	Natural
-----------------------	---------

Contact Features

--	--



Contact Layout	Inline
Contact Type	Pin
Contact Base Material	Copper Alloy

Termination Features

Termination Method to Wire & Cable	Crimp
------------------------------------	-------

Mechanical Attachment

Strain Relief	Without
Panel Mount Feature	Without
PCB Mount Retention	Without
Mating Retention Type	Latch
Mating Retention	With
Connector Mounting Type	Cable Mount (Free-Hanging)

Housing Features

Housing Entry Configuration	Both Ends Open
Housing Material	Nylon 6/6 GF
Centerline (Pitch)	2.5 mm[.098 in]

Dimensions

Connector Length	12.1 mm[.476 in]
Connector Height	7.45 mm[.293 in]

Usage Conditions

Operating Temperature Range	-30 – 105 °C[-22 – 221 °F]
-----------------------------	----------------------------

Operation/Application

Circuit Application	Power & Signal
---------------------	----------------

Industry Standards

Glow Wire Rating	Standard Part - Not Glow Wire
UL Flammability Rating	UL 94V-0

Packaging Features

Packaging Quantity	600
Packaging Method	Bag

Product Compliance

[For compliance documentation, visit the product page on TE.com>](#)



EU RoHS Directive 2011/65/EU	Compliant
EU ELV Directive 2000/53/EC	Compliant
China RoHS 2 Directive MIIT Order No 32, 2016	No Restricted Materials Above Threshold
EU REACH Regulation (EC) No. 1907/2006	Current ECHA Candidate List: JUNE 2023 (235) Candidate List Declared Against: JAN 2023 (233) Does not contain REACH SVHC
Halogen Content	Not Low Halogen - contains Br or Cl > 900 ppm.
Solder Process Capability	Not applicable for solder process capability

Product Compliance Disclaimer

This information is provided based on reasonable inquiry of our suppliers and represents our current actual knowledge based on the information they provided. This information is subject to change. The part numbers that TE has identified as EU RoHS compliant have a maximum concentration of 0.1% by weight in homogenous materials for lead, hexavalent chromium, mercury, PBB, PBDE, DBP, BBP, DEHP, DIBP, and 0.01% for cadmium, or qualify for an exemption to these limits as defined in the Annexes of Directive 2011/65/EU (RoHS2). Finished electrical and electronic equipment products will be CE marked as required by Directive 2011/65/EU. Components may not be CE marked. Additionally, the part numbers that TE has identified as EU ELV compliant have a maximum concentration of 0.1% by weight in homogenous materials for lead, hexavalent chromium, and mercury, and 0.01% for cadmium, or qualify for an exemption to these limits as defined in the Annexes of Directive 2000/53/EC (ELV). Regarding the REACH Regulation, the information TE provides on SVHC in articles for this part number is based on the latest European Chemicals Agency (ECHA) 'Guidance on requirements for substances in articles' posted at this URL: <https://echa.europa.eu/guidance-documents/guidance-on-reach>

Compatible Parts



TE Part # 7-1747072-4
GRACE INERTIA CONN 2.5 ON TAPE HDR 4P BL



TE Part # CAT-G7534A-R2435
Sig GRACE INERTIA Receptacle



TE Part # 2-1747067-4
GRACE INERTIA CONN 2.5 HDR ASSY 4P BLUE



TE Part # 2-1903393-3
GIC 2.5 W CAP HSG 4P BLUE



TE Part # 5-1747072-4
GRACE INERTIA CONN 2.5 ON TAPE HDR 4P NA



TE Part # 1-1903393-2
GIC 2.5 W CAP HSG 4P RED



TE Part # 1903393-1
GIC 2.5 W CAP HSG 4P NATURAL



TE Part # 3-1903393-4
GIC 2.5 W CAP HSG 4P YELLOW



Also in the Series | GRACE INERTIA 2.5

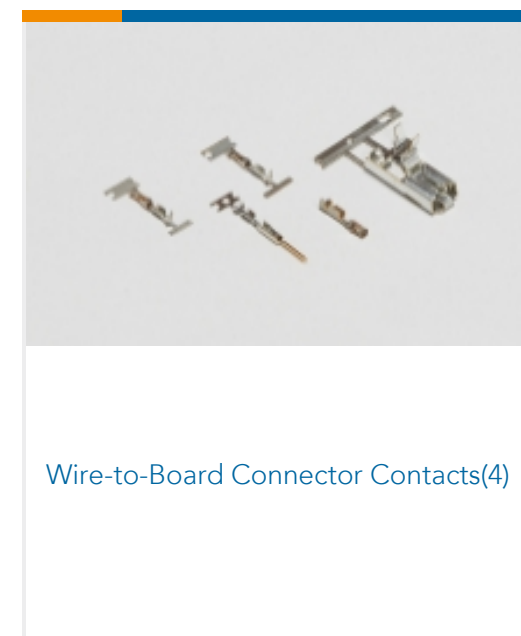
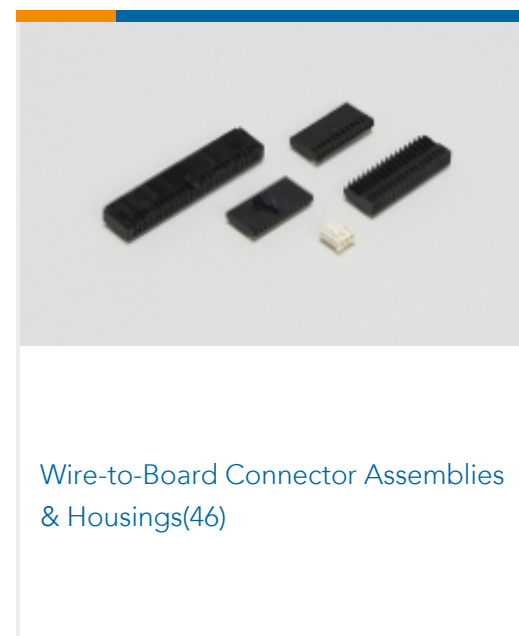
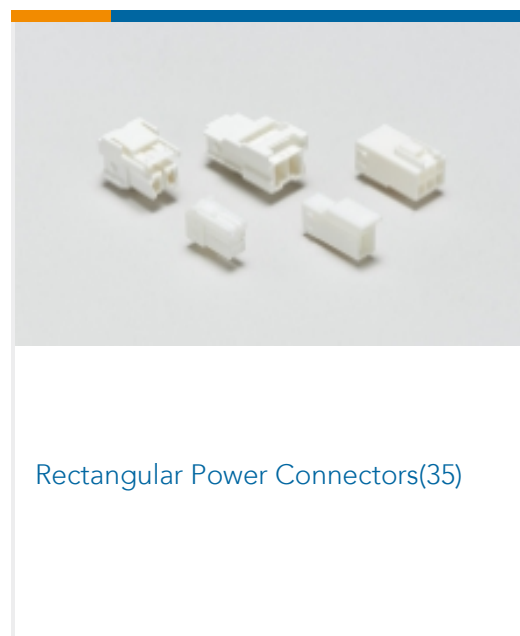
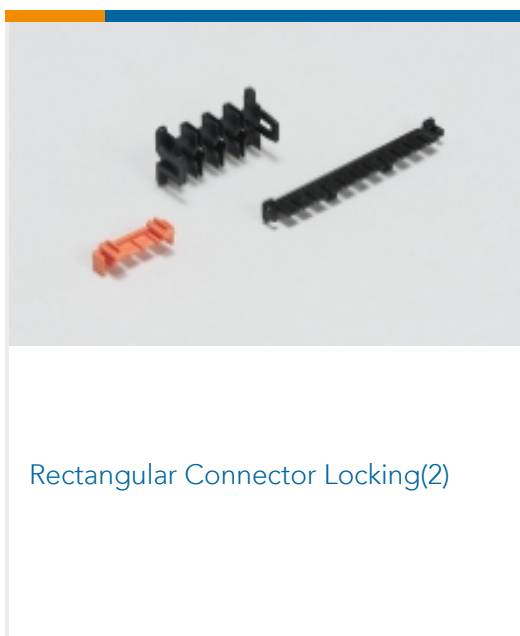
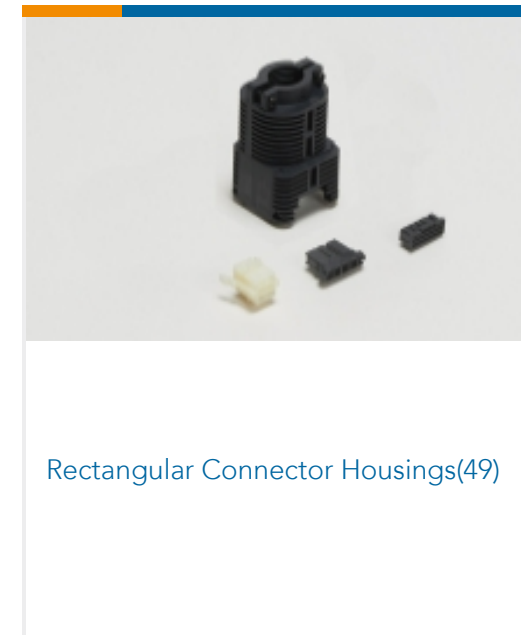
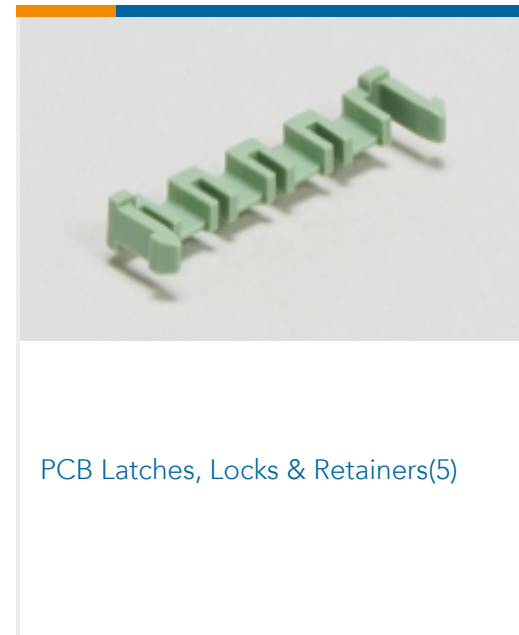
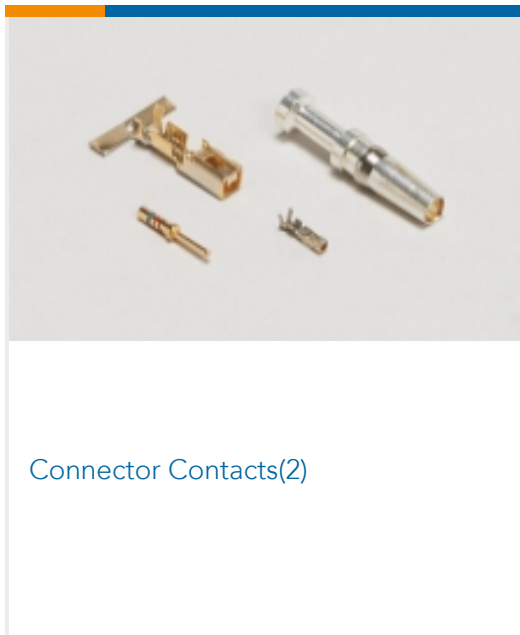

Customers Also Bought

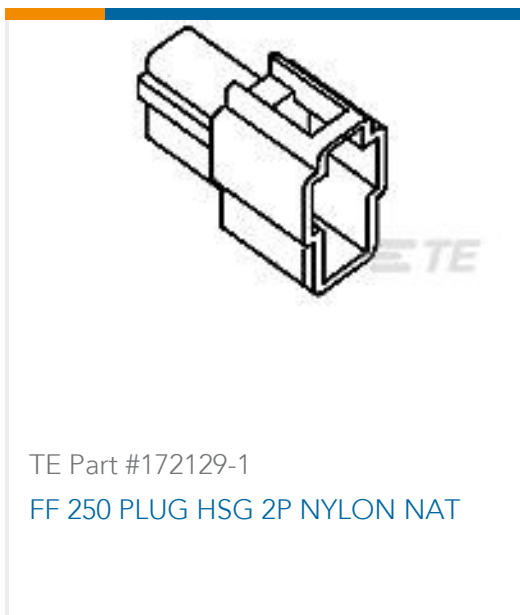



Documents

Product Drawings

[GRACE INERTIA CONN 2.5 PLUG HSG 4P NATUR](#)

English

CAD Files

[3D PDF](#)

3D

Customer View Model

[ENG_CVM_CVM_1747066-4_E1.2d_dxf.zip](#)

English

Customer View Model

[ENG_CVM_CVM_1747066-4_E1.3d_igs.zip](#)

English

Customer View Model

[ENG_CVM_CVM_1747066-4_E1.3d_stp.zip](#)

English

By downloading the CAD file I accept and agree to the [Terms and Conditions](#) of use.

Product Specifications

[Application Specification](#)

English

Product Environmental Compliance

[MD_1747066-4_12082017853_dmtec](#)

English

[MD_1747066-4_12082017853_dmtec](#)

English